

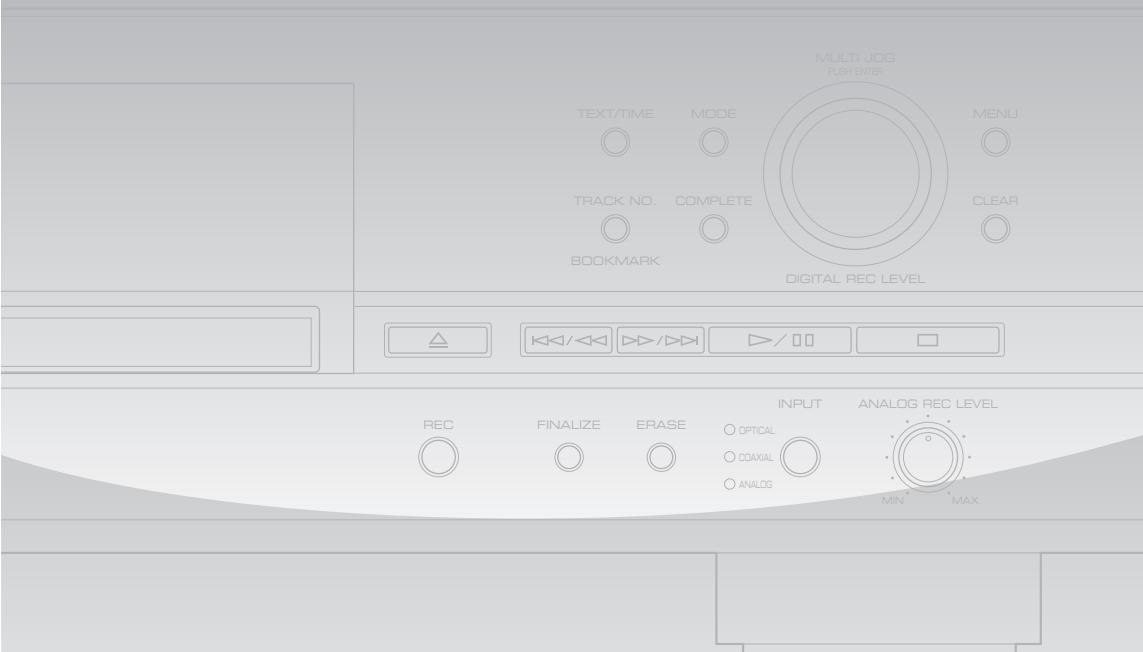

CDR-HD1300 CDR-HD1300E



HDD/CD Recorder

Enregistreur CD/Disque Dur

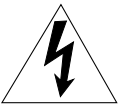

**OWNER'S MANUAL
MODE D'EMPLOI**

IMPORTANT SAFETY INSTRUCTIONS

| | | |
|--|---|---|
|  | CAUTION RISK OF ELECTRIC SHOCK DO NOT OPEN |  |
| <p>CAUTION: TO REDUCE THE RISK OF ELECTRIC SHOCK, DO NOT REMOVE COVER (OR BACK). NO USER-SERVICEABLE PARTS INSIDE. REFER SERVICING TO QUALIFIED SERVICE PERSONNEL.</p> | | |

• Explanation of Graphical Symbols

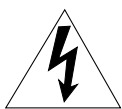

The lightning flash with arrowhead symbol, within an equilateral triangle, is intended to alert you to the presence of uninsulated “dangerous voltage” within the product’s enclosure that may be of sufficient magnitude to constitute a risk of electric shock to persons.



The exclamation point within an equilateral triangle is intended to alert you to the presence of important operating and maintenance (servicing) instructions in the literature accompanying the appliance.

IMPORTANT!

Please record the serial number of this unit in the space below.

Model:

Serial No.:

The serial number is located on the rear of the unit.

Retain this Owner’s Manual in a safe place for future reference.

- 1 Read these instructions.
- 2 Keep these instructions.
- 3 Heed all warnings.
- 4 Follow all instructions.
- 5 Do not use this apparatus near water.
- 6 Clean only with dry cloth.
- 7 Do not block any ventilation openings. Install in accordance with the manufacturer’s instructions.
- 8 Do not install near any heat sources such as radiators, heat registers, stoves, or other apparatus (including amplifiers) that produce heat.
- 9 Do not defeat the safety purpose of the polarized or grounding-type plug. A polarized plug has two blades with one wider than the other. A grounding type plug has two blades and a third grounding prong. The wide blade or the third prong are provided for your safety. If the provided plug does not fit into your outlet, consult an electrician for replacement of the obsolete outlet.
- 10 Protect the power cord from being walked on or pinched particularly at plugs, convenience receptacles, and the point where they exit from the apparatus.
- 11 Only use attachments/accessories specified by the manufacturer.
- 12 Use only with the cart, stand, tripod, bracket, or table specified by the manufacturer, or sold with the apparatus. When a cart is used, use caution when moving the cart/apparatus combination to avoid injury from tip-over.
- 13 Unplug this apparatus during lightning storms or when unused for long periods of time.
- 14 Refer all servicing to qualified service personnel. Servicing is required when the apparatus has been damaged in any way, such as power-supply cord or plug is damaged, liquid has been spilled or objects have fallen into the apparatus, the apparatus has been exposed to rain or moisture, does not operate normally, or has been dropped.



FCC INFORMATION (for US customers)

1. IMPORTANT NOTICE: DO NOT MODIFY THIS UNIT!

This product, when installed as indicated in the instructions contained in this manual, meets FCC requirements.

Modifications not expressly approved by Yamaha may void your authority, granted by the FCC, to use the product.

2. IMPORTANT:

When connecting this product to accessories and/or another product use only high quality shielded cables. Cable/s supplied with this product MUST be used. Follow all installation instructions. Failure to follow instructions could void your FCC authorization to use this product in the USA.

3. NOTE:

This product has been tested and found to comply with the requirements listed in FCC Regulations, Part 15 for Class "B" digital devices. Compliance with these requirements provides a reasonable level of assurance that your use of this product in a residential environment will not result in harmful interference with other electronic devices.

This equipment generates/uses radio frequencies and, if not installed and used according to the instructions found in the users manual, may cause interference harmful to the operation of other electronic devices.

Compliance with FCC regulations does not guarantee that interference will not occur in all installations. If this product is found to be the source of interference, which can be determined by turning the unit "OFF" and "ON", please try to eliminate the problem by using one of the following measures:

Relocate either this product or the device that is being affected by the interference.

Utilize power outlets that are on different branch (circuit breaker or fuse) circuits or install AC line filter/s.

In the case of radio or TV interference, relocate/reorient the antenna. If the antenna lead-in is 300 ohm ribbon lead, change the lead-in to coaxial type cable.

If these corrective measures do not produce satisfactory results, please contact the local retailer authorized to distribute this type of product. If you can not locate the appropriate retailer, please contact Yamaha Electronics Corp., U.S.A. 6660 Orangethorpe Ave, Buena Park, CA 90620.

The above statements apply ONLY to those products distributed by Yamaha Corporation of America or its subsidiaries.

We Want You Listening For A Lifetime

YAMAHA and the Electronic Industries Association's Consumer Electronics Group want you to get the most out of your equipment by playing it at a safe level. One that lets the sound come through loud and clear without annoying blaring or distortion – and, most importantly, without affecting your sensitive hearing. Since hearing damage from loud sounds is often undetectable until it is too late, YAMAHA and the Electronic Industries Association's Consumer Electronics Group recommend you to avoid prolonged exposure from excessive volume levels.



CAUTION: READ THIS BEFORE OPERATING THIS UNIT

- To assure the finest performance, please read this manual carefully. Keep it in a safe place for future reference.
- Install this unit in a well ventilated, cool, dry, clean place – away from direct sunlight, heat sources, vibration, dust, moisture, and/or cold. Avoid ventilation space of at least 30 cm on the top, 20 cm on the left and right, and 10 cm on the back of this unit.
- Locate this unit away from other electrical appliances, motors, or transformers to avoid humming sounds.
- Do not expose this unit to sudden temperature changes from cold to hot, and do not locate this unit in an environment with high humidity (i.e. a room with a humidifier) to prevent condensation inside this unit, which may cause an electrical shock, fire, damage to this unit, and/or personal injury.
- Avoid installing this unit where foreign object may fall onto this unit and/or this unit may be exposed to liquid dripping or splashing. On the top of this unit, do NOT place:
 - Other components, as they may cause damage and/or discoloration on the surface of this unit.
 - Burning objects (i.e. candles), as they may cause fire, damage to this unit, and/or personal injury.
 - Containers with liquid in them, as they may fall and liquid may electrical shock to the user and/or damage to this unit.
- Do not cover the rear panel of this unit with a newspaper, tablecloth, curtain, etc. in order not to obstruct heat radiation. If the temperature inside this unit rises, it may cause fire, damage to this unit, and/or personal injury.
- Do not plug in this unit to a wall outlet until all connections are complete.
- Do not operate this unit upside-down. It may overheat, possibly causing damage.
- Do not use force on switches, knobs and/or cords.
- When disconnecting the power cord from the wall outlet, grasp the plug; do not pull the cord.
- Do not clean this unit with chemical solvents; this might damage the finish. Use a clean, dry cloth.
- Only voltage specified on this unit must be used. Using this unit with a higher voltage than specified is dangerous and may cause fire, damage to this unit, and/or personal injury. YAMAHA will not be held responsible for any damage resulting from use of this unit with a voltage other than specified.
- To prevent damage by lightning, disconnect the power cord from the wall outlet during an electrical storm.
- Do not attempt to modify or fix this unit. Contact qualified YAMAHA service personnel when any service is needed. The cabinet should never be opened for any reasons.
- When not planning to use this unit for long periods of time (i.e. vacation), disconnect the AC power plug from the wall outlet.
- Be sure to read the “TROUBLESHOOTING” section on common operating errors before concluding that this unit is faulty.
- Before moving this unit, first check that there is no disc in the disc tray. Finally, press **POWER** to turn off this unit, and disconnect the AC power plug from the wall outlet.

WARNING

TO REDUCE THE RISK OF FIRE OR ELECTRIC SHOCK, DO NOT EXPOSE THIS UNIT TO RAIN OR MOISTURE.

Laser component in this product is capable of emitting radiation exceeding the limit for Class 1.

SPECIAL INSTRUCTIONS FOR U.K. MODEL

IMPORTANT

The wires in this mains lead are colours in accordance with the following code:

GREEN-and-YELLOW:Earth

BLUE:Neutral

BROWN:Live

As the colours of the wires in the mains lead of this apparatus may not correspond with the coloured markings identifying the terminals in your plug proceed as follows: The wire which is coloured GREEN-and-YELLOW must be connected to the terminal in the plug which is marked by the letter E or by the safety earth symbol \perp or coloured GREEN or GREEN-and-YELLOW. The wire which is coloured BLUE must be connected to the terminal which is marked with the letter N or coloured BLACK. The wire which is coloured BROWN must be connected to the terminal which is marked with the letter L or coloured RED.

For U.K. customers

If the socket outlets in the home are not suitable for the plug supplied with this appliance, it should be cut off and an appropriate 3 pin plug fitted. For details, refer to the instructions described above.

Note: The plug severed from the mains lead must be destroyed, as a plug with bared flexible cord is hazardous if engaged in a live socket outlet.

For Canadian Customers

To prevent electric shock, match wide blade of plug to wide slot and fully insert.

This Class B digital apparatus complies with Canadian ICES–003.

Hard Disk Drive (HDD)

■ Before using

- If you purchase CDR-HD1300; this model is not equipped with a hard disk drive (HDD). Please purchase a commercially available HDD for internal use and install it on this unit correctly, following the attached instruction.
- It is necessary to format a new HDD after installation. Also refer the attached instruction for formatting.
- If you purchase CDR-HD1300E; this model is equipped with an HDD.

■ Capacity of the HDD

Following table shows the total recordable time for different capacities of an HDD.

| Capacity | Total recordable time |
|----------|-----------------------|
| 20 GB | Approx. 30 hours |
| 40 GB | Approx. 60 hours |
| 60 GB | Approx. 90 hours |
| 80 GB | Approx. 120 hours |

■ Handling of the HDD

- The HDD formatted on your CDR-HD1300 cannot be used on other CDR-HD1300s for any reading or writing. If you wish to use the HDD that has been formatted on other CDR-HD1300 on yours, format it again on your CDR-HD1300. See page 85 for formatting.
- Carefully handle an HDD before installation because it is a precision device. Also do not give vibration or shock to this unit after the HDD is installed. Incorrect operation can damage the HDD and/or the data written onto the HDD.
- Yamaha and suppliers accept no liability for the loss and/or damage of data caused by vibration and/or shock.

■ CD player mode

This unit does not make any recordings if no HDD is installed. In this case, only reading of a CD, CD-R, and CD-RW disc is possible. Permit some time until this unit becomes ready after the power is turned if no HDD is installed.

About This Manual

■ Structure

This owner's manual is composed of following sections.

GETTING STARTED

This section explains necessary preparations such as remote control and connection. Please read this before using this unit.

COPYING AND RECORDING ONTO THE HDD

This section describes basic operations; copying from a CD to the HDD and recording from an external component connected to this unit to the HDD. Additional functions and operations are explained in "Advanced Operations" following this basic operation. Skip this part, if you wish to try to use all the basic functions equipped on this unit.

EDITING

This section describes how to edit the data copied and/or written on the HDD. Editing method is explained for "album", "track", and "disc" respectively. See "EDITING MENU ITEMS" for outline of the editing menu.

COPYING AND RECORDING ONTO A CD-R OR CD-RW DISC

This section describes basic operations; copying from the HDD to a CD-R or CD-RW and recording from an external component connected to this unit to a CD-R or CD-RW. Additional functions and operations are explained in "Advanced Operations" following these basic operations. Skip this part, if you wish to try to use all the basic functions equipped on this unit.

DUPLICATION OF A CD

This section describes how to duplicate a whole CD.

PLAYBACK

This section describes how to play the data copied/written on the HDD, your original CDs that are made using this unit, or commercially available CDs.

APPENDIX

This section provides you with the information about system setting of this unit and troubleshooting.

■ About this manual

- This manual is printed prior to production. Design and specifications are subject to change in part for the reason of the improvement in operativity ability, and others. In this case, the product has priority.
- Some of the illustrations and names of the package contents etc written in this manual may differ from the actual products and the names written on the package etc.

Features

- Copying a CD to the HDD at maximum 10x speed
- Copying data on the HDD to a CD-R disc at maximum 8x speed
- Copying data on the HDD to a CD-RW disc at maximum 4x speed
- High quality recording by the Audio Master Quality Recording (copying from the HDD to a CD-R only)
- Long-hour-recording useful for recording satellite broadcasting programs and timer recording using an external timer

Contents

GETTING STARTED

| | |
|---|----|
| SUPPLIED ACCESSORIES | 2 |
| CD/CD-R/CD-RW COMPATIBLE WITH THIS UNIT | 3 |
| RULES OF DIGITAL RECORDING AND NOTES ON SYSTEM | 5 |
| Rules of Digital Recording | 5 |
| Notes on System | 5 |
| Data on the HDD | 6 |
| NAMES OF BUTTONS AND CONTROLS | 7 |
| Front Panel | 7 |
| Remote Control | 8 |
| Display | 10 |
| Display Information | 11 |
| Rear Panel | 12 |
| CONNECTIONS | 12 |

COPYING AND RECORDING ONTO THE HDD

| | |
|--|----|
| COPYING FROM A CD ONTO THE HDD | 14 |
| Copying All Tracks on a CD | 14 |
| Copying Favorite Tracks on the CD | 16 |
| Advanced Operations | 17 |
| RECORDING FROM AN EXTERNAL COMPONENT ONTO THE HDD | 20 |
| Recording from the Digital Components | 20 |
| Recording from the Analog Components | 21 |
| Recording Using an External Timer | 22 |
| Adjusting the Recording Level | 24 |
| Advanced Operations | 25 |

EDITING

| | |
|---------------------------------|----|
| EDITING MENU ITEMS | 29 |
| ALBUM EDITING | 30 |
| Album Editing Operation | 30 |
| TRACK EDITING | 39 |
| Track Editing Operation | 39 |
| DISC EDITING | 52 |
| Disc Editing Operation | 52 |
| UNDO FUNCTION | 58 |
| BOOKMARK | 59 |

COPYING AND RECORDING ONTO A CD-R OR CD-RW DISC

| | |
|---|----|
| COPYING FROM THE HDD ONTO A CD-R OR CD-RW DISC | 60 |
| Copying a Whole Group (Disc, Album or Bookmark) | 60 |
| Copying Favorite Tracks on the HDD | 62 |
| High Quality Copying | 63 |
| Advanced Operations | 64 |
| RECORDING FROM AN EXTERNAL COMPONENT ONTO A CD-R OR CD-RW DISC | 67 |
| Advanced Operations | 69 |
| FINALIZATION | 70 |
| ERASING A CD-RW DISC | 71 |

DUPLICATION OF A CD

| | |
|----------------------------------|----|
| DUPLICATION OF A CD | 72 |
| High Quality Duplication | 74 |

PLAYBACK

| | |
|---|----|
| PLAYBACK | 76 |
| Playing a CD | 76 |
| Playing Tracks on the HDD | 76 |
| Finding the Desired Passage (Search) | 77 |
| Finding the Desired Group (Group Skip) | 77 |
| Finding the Desired Track (Track Skip) | 78 |
| Selecting Tracks Using On-Screen-Display (OSD) | 79 |
| Listening with Headphones | 79 |
| VARIOUS PLAYBACK | 80 |
| Finding the Desired Passage by Time (Time Search) | 80 |
| Setting the Play Style | 80 |
| Single Repeat Play | 81 |
| Full Repeat Play | 82 |
| Random Play | 82 |
| Intro Play | 83 |
| Bookmark Play | 83 |

APPENDIX

| | |
|--|----|
| DAC (DIGITAL/ANALOG CONVERTER) MODE | 84 |
| HDD UTILITY | 85 |
| SYSTEM UTILITY | 86 |
| ON-SCREEN DISPLAY (OSD) | 89 |
| DISPLAY MESSAGES | 90 |
| TROUBLESHOOTING | 92 |
| ABOUT PRODUCT INFORMATIONS | 93 |
| SPECIFICATIONS | 94 |

SUPPLIED ACCESSORIES

Make sure the following items are included in your package.

- Remote Control

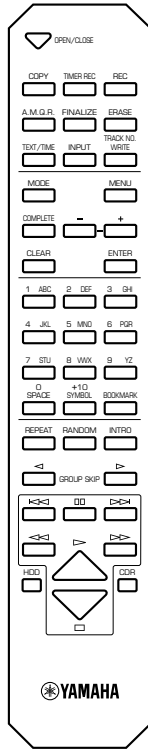

- Batteries (size AA, UM-3, or R6) (2)

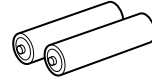

- Audio Pin Cables (2)

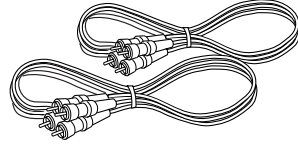

- Optical Cable

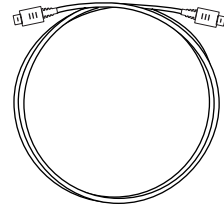

- Video Pin Cable

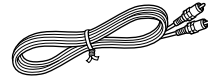

- Power Cable (for U.S.A. model)

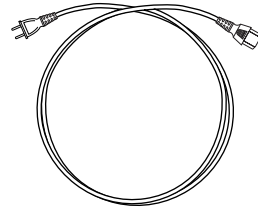

- Coaxial Cable (for U.S.A. model)

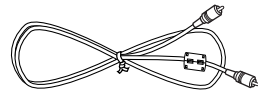

■ Discs that can be used for recording on this unit

Be sure to use only CD-R and CD-RW discs made by reliable manufacturers.

CD-R and CD-RW digital audio discs that display either of the following marks can be used with this unit.



FOR CONSUMER
FOR CONSUMER USE
FOR MUSIC USE ONLY

■ Discs that can be used for recording

- CD-R discs can only be recorded on once, and the recorded material cannot be erased.
- CD-RW discs can be recorded on, have the recorded material erased, and then recorded on again any number of times.

■ Discs that cannot be used for recording on this unit

- Discs bearing marks other than those shown above.
- Discs intended for recording computer data.
- Discs intended for professional use or labeled “FOR PROFESSIONAL USE ONLY”.

■ 79-minute CD-R disc

The actual recordable time of the CD-R disc with “80” written on its package is 79 minutes 57 seconds. This manual describes such CD-R disc as “79-minute CD-R disc”.

■ Finalization of CD-R/CD-RW discs

To play back CD-R discs on a standard CD player and CD-RW discs on CD-RW-compatible players, you need to perform the process known as “finalization”. In the finalization process, the Table of Contents (TOC) is written onto the discs.

Finalized CD-R discs

- CD-R discs can be played on a standard CD player.
- Further recording onto CD-R discs is not possible.
- Some CD players may not play back the finalized CD-R discs properly due to differences in the playback system of different manufacturers.

Finalized CD-RW discs

- CD-RW discs cannot be played on a standard CD player. CD-RW discs can be played back on CD-RW-compatible players such as this unit.
- Tracks written on CD-RW discs can be erased, and additional tracks can be recorded after the TOC has been erased.

■ Erasure or loss of data

Yamaha and suppliers accept no liability for the loss of data written on the HDD and CD-R or CD-RW discs, or any problems caused as a result of using this unit. As a precaution, it is recommended that the discs are tested after they have been recorded on. Furthermore, under no circumstances do Yamaha and suppliers guarantee the reliability of the discs.

■ Discs that can be played back

In addition to CD-R and CD-RW digital audio discs described above, commercially available pre-recorded CDs bearing the marks shown below can also be played on this unit.



Caution

- If you use the CDs that do not meet the CD standards, this unit may not operate properly.

■ Playback of the CD-R disc copied with the Audio Master Quality Recording mode

The Audio Master Quality Recording mode enables you to create a CD with high quality sounds by increasing the linear velocity when copying. The CD-R discs copied with this mode meet the CD standards and can be played on a standard CD player. However, some CD recorders may not play back these CD-R discs properly.

■ Playback on DVD players



Before playing back a finalized CD-R or CD-RW discs on a DVD player, please check whether the DVD player is compatible with CD-R or CD-RW discs or not. Refer to the owner’s manual of the DVD player for more information. CD-R or CD-RW discs cannot be played on a DVD player that is not compatible with CD-R or CD-RW discs.

IMPORTANT

- Please check the copyright laws in your country to record from records, CDs, radio, etc. Recording of copyright material may infringe copyright laws.

■ Handling of discs

Heed the following notes on handling of discs not to create any cause for a recording failure, a loss of the recorded data, or a malfunction of this unit.

- This compact disc recorder is designed for use with CDs (including 8cm [3"] discs) bearing the , , or  marks only. Never attempt to load any other type of disc into this unit.
- CDs are not subjected to wear during play. However if the disc is handled improperly, damage may be created on the disc to adversely affect the disc's play.
- When writing on the label side of CD-R or CD-RW discs, use an oil-based felt-tipped pen.
- Do not use cleaning discs or warped discs. All of these could damage this unit.
- Although playback of CDs is generally not affected by small particles of dust or fingerprints on their playing surface, dust, fingerprints, small scratches and direct sunlight on the recording surface of a CD-R or CD-RW disc may make recording impossible. Therefore, for optimal performance of the recorder and for long-term enjoyment of your CD collection, handle discs correctly as outlined in the following guidelines.
 1. Hold discs by touching only the edges or center hole.
 2. When a disc is not currently being used, remove it from the recorder and store in an appropriate case.
 3. With proper disc maintenance, cleaning should not be necessary. However, should cleaning be required, wipe by using a clean, dry cloth. Do not wipe with a circular motion; wipe straight outward from the center.

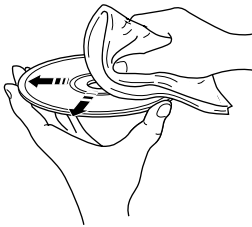

- Do not try to clean the disc's surface by using any type of disc cleaner, record spray, antistatic spray or liquid, or any other chemical-based liquid, because such substances might irreparably damage the disc's surface.
- Do not expose discs to direct sunlight, high temperature, or high humidity for a long period of time, because this might warp or otherwise damage the disc.



■ To prevent a malfunction of this unit

- Do not use any non-standard shaped CDs (heart, flower shaped, etc.) available on the market, because they are off-balance in their weight.

If a non-standard shaped CD is loaded into this unit, it may create problems such as improper playback, opening the disc tray, creating an usual noise, and this unit's failure.

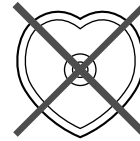

- Be sure to use a felt-tip pen or similar writing tool when writing on the label side of the disc. Do not use a ball-point pen, pencil, or other hard-tipped writing tool, as these may damage the disc and may adversely affect further recording on the disc.
- Do not use the discs with glue left on their surface. It may get stuck in this unit or create damage to this unit.
- When using an 8cm (3") disc, do not place a normal 12cm (5") disc on top of it.
- Do not use the discs printed with commercially available label printers.

Rules of Digital Recording

■ SCMS—Serial Copy Management System

As a digital audio component, this unit conforms with the Serial Copy Management System (SCMS) standards. The Serial Copy Management System restricts copies made by recording digital signals to first-generation copies only.

The digital program sources that have been recorded cannot be digitally recorded again.

There are 2 rules as follows:

Rule 1

Digital sources such as commercially available CDs can be copied digitally onto other recordable digital media with this unit (a first-generation digital copy). However, the first-generation digital copy cannot be copied digitally any further.

Rule 2

The source that was recorded via the **ANALOG LINE IN (REC)** jacks can be copied digitally onto other recordable digital media (a first-generation digital copy). However, the first-generation digital copy cannot be copied digitally any further.

This unit monitors the SCMS status for each track when a digital recording is made. If the track is protected from digital recording and copying, it is not possible to make a digital recording and copy of that track.

The SCMS standard does not apply to analog recording and copying.

When making a copy from a CD onto the HDD, or from the HDD onto a CD-R or CD-RW disc, any of the copy methods described below can be selected. The following selections are contained in “Copy Method”.

- “Auto Dig/Anlg”:
Automatically switches to analog recording if the track cannot be digitally recorded for SCMS.
- “Digital Copy”:
Performs digital copying of only those tracks that can be digitally copied.
- “Digital Move”:
Performs digital copying of the tracks that cannot be digitally copied by “Digital Copy” when copying from the HDD onto a CD-R or CD-RW disc.
- “Analog Copy”:
Performs analog copying regardless of the SCMS standard.

■ Digital Move

This unit has a built-in HDD with large space that makes a long recording possible. You can create your own CD by editing the various program sources that have been recorded onto the HDD of this unit and copying them onto a CD-R or CD-RW disc. If you want to make a digital copy of the original data that has been created on the HDD to a CD-R or CD-RW disc, the “Digital Move” method is convenient. You can make a digital copy from the HDD onto a CD-R or CD-RW disc even if the track is protected from making a second-generation copy by the SCMS standard. However, since the concept of “Digital Move” is that the data is moved from the HDD onto a CD-R or CD-RW disc, the original data on the HDD is erased when moving is complete. See page 65 for details.

Notes on System

■ Number of recordable discs and tracks and their length

- One CD-R or CD-RW disc, or one disc on the HDD can be recorded with up to 99 tracks on them.
- Once 99 tracks have been recorded, no further recording is possible even if space for recording is available on the disc.
- The minimum length of one track must be 4 seconds. If a recording is stopped while the track is less than 4 seconds long, this unit will record for 4 seconds, and then stop recording. The maximum length of one track is 99 minutes 59 seconds for the HDD.
- 999 discs can be created at maximum on the HDD of this unit. However, the number of discs that can be created is limited according to the space availability (total recordable time) on the HDD.
- The maximum length of one disc on the HDD is 99 minutes 59 seconds. However, since each track on the HDD is handled in the unit of frame (75 frames are equal to one second), the maximum length of one track or disc may vary slightly.
- When recording on a CD-R or CD-RW disc, 2-second silence will be automatically added to the beginning of the first track. Therefore the actual total recordable time will be 2 seconds shorter than the total recordable time of a CD-R or CD-RW disc.

■ Source sampling rate conversion

- Digital input of this unit supports sampling frequencies of 32kHz, 44.1kHz, 48kHz, and 96kHz. This unit converts these inputs to the 44.1kHz, 16-bit digital signals and records them onto the HDD, or a CD-R or CD-RW disc.
- Analog input is also converted to the same digital signal to be recorded.
- This unit outputs the signals at the sampling frequency of 44.1kHz, 16-bit from its digital output.

■ Recording of non-audio signals

- This unit is designed exclusively for recording audio signals. Recording is only possible for audio signals.
- When a CD with CD TEXT is copied onto the HDD, CD TEXT will be automatically copied if it is not copy protected. When a CD with CD TEXT is recorded from an external CD player, CD TEXT cannot be copied even if it is not copy protected. To copy CD TEXT, use the built-in CDR drive of this unit.
- If the digital signals contain graphic data such as CD graphics, the non-audio signals will not be recorded.
- It is not possible to record from non-audio sources such as CD-ROM or DVD.

■ Data processing

- A small amount of space may be used for data processing besides recording the actual program sources.
- Although this unit is capable of recording 999 albums at maximum onto the HDD, the data processing speed may slow down if a large number of albums is created.

Data on the HDD

The data recorded onto the built-in HDD of this unit will be numbered and organized based on the following concept:

Disc

One consequent recording is counted and numbered as one unit of disc. The HDD of this unit can record 999 discs at maximum. (However, the number of discs to be created may be less than 999 for the space availability on the HDD.) The maximum length of one disc on the HDD is 99minutes 59 seconds.

Track

99 tracks can be recorded onto a disc at maximum. (However the number of discs tracks to be recorded may be less than 99 for the space availability on the HDD.) One track must be 4 seconds at shortest and 99 minutes 59 seconds at longest.

Album

A group of the source programs selected from different discs and recorded as the playlist is called "album". "Album" corresponds to the "program" function (to play back favorite tracks in the desired order) of a standard CD player. This unit can record 999 albums at maximum onto the HDD.

Bookmark

This unit can make a temporary bookmark on a favorite track as playing back. The list of the program sources marked is called "bookmark". This marking is temporary and cannot be duplicated. However, an album can be easily created by copying the bookmarked tracks. See page 32 for details.

Group

A collection of disc(s), album(s), and a bookmark are generically called "group".

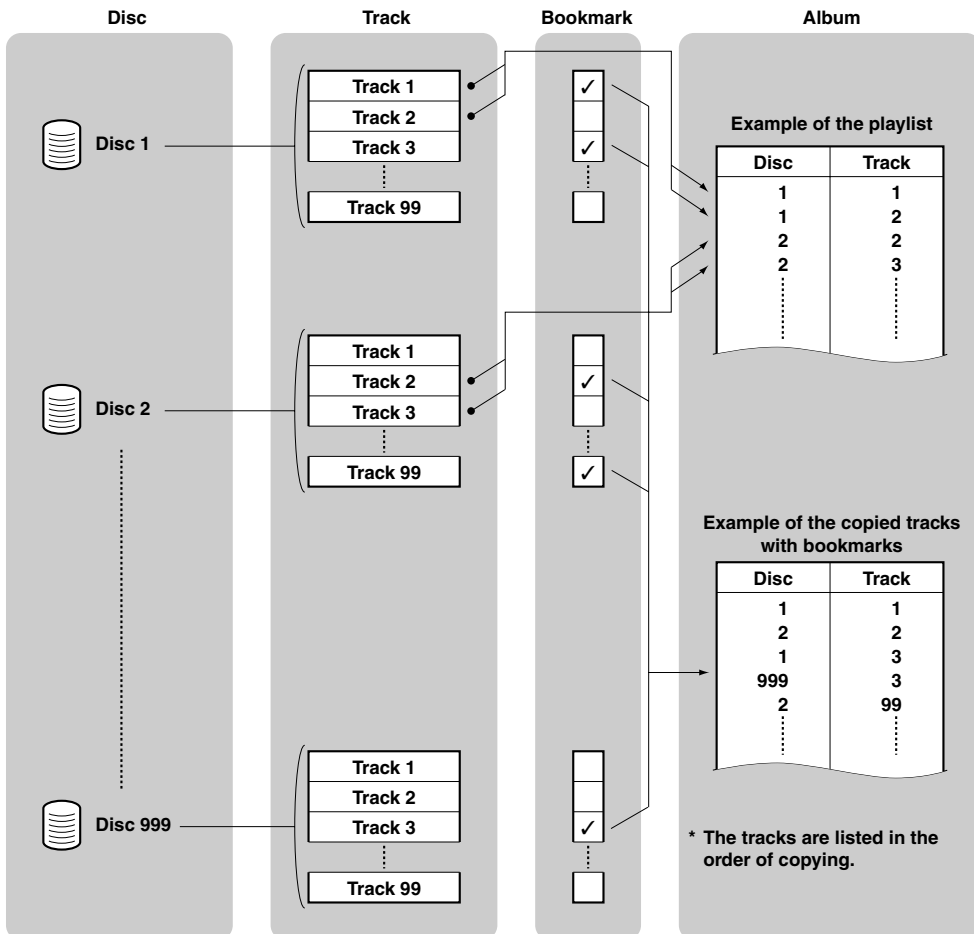

Front Panel

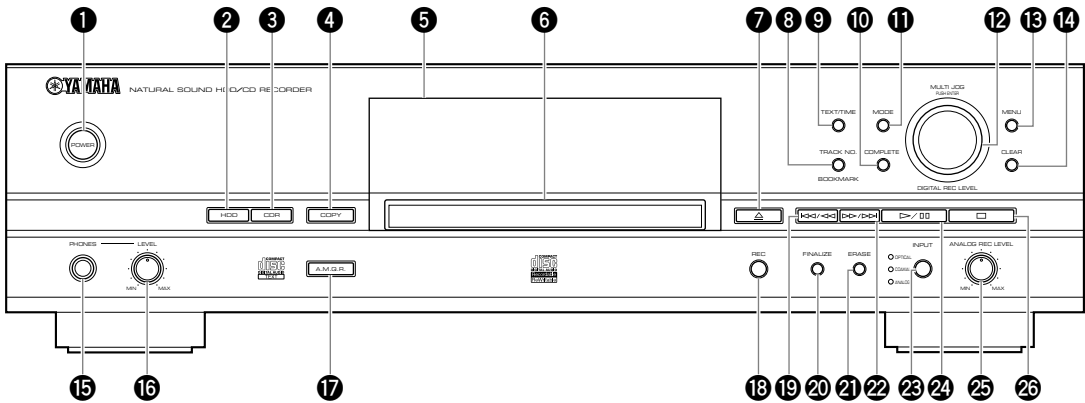

- | | |
|--|------------------------------------|
| 1 POWER | 14 CLEAR |
| 2 HDD | 15 PHONES jack |
| 3 CDR | 16 PHONES LEVEL control |
| 4 COPY | 17 A.M.Q.R. |
| 5 Front panel display | 18 REC |
| 6 Disc tray | 19 ⏪/⏩ (Skip/Search) |
| 7 △ (Open/Close) | 20 FINALIZE |
| 8 TRACK NO./BOOKMARK | 21 ERASE |
| 9 TEXT/TIME | 22 ⏩/⏪ (Search/Skip) |
| 10 COMPLETE | 23 INPUT |
| 11 MODE | 24 ▷/⏸ (Play/Pause) |
| 12 MULTI JOG knob/DIGITAL REC LEVEL control | 25 ANALOG REC LEVEL control |
| 13 MENU | 26 □ (Stop) |

Remote Control

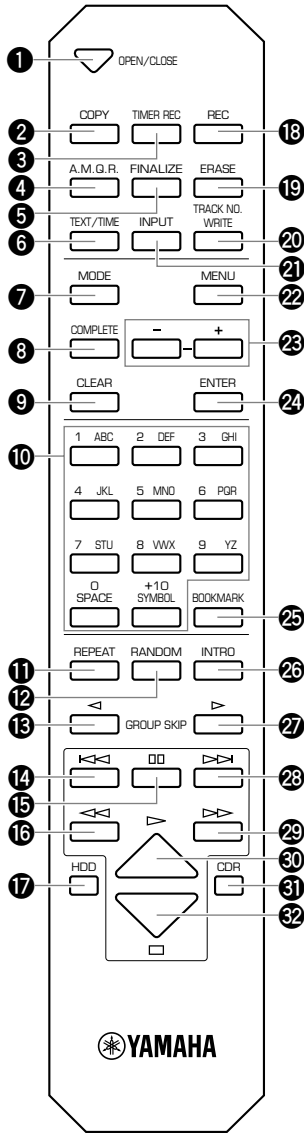

- ❶ OPEN/CLOSE
- ❷ COPY
- ❸ TIMER REC
- ❹ A.M.Q.R.
- ❺ FINALIZE
- ❻ TEXT/TIME
- ❼ MODE
- ❽ COMPLETE
- ❾ CLEAR
- ❿ Alphabetical/numeric buttons
- ⓫ REPEAT
- ⓬ RANDOM
- ⓭ GROUP SKIP ◀
- ⓮ ⏪ (Track Skip)
- ⓯ ⏸ (Pause)
- ⓰ ⏩ (Search)
- ⓱ HDD
- ⓲ REC
- ⓳ ERASE
- ⓴ TRACK NO. WRITE
- ⓵ INPUT
- ⓶ MENU
- ⓷ +/-
- ⓸ ENTER
- ⓹ BOOKMARK
- ⓺ INTRO
- ⓻ GROUP SKIP ▶
- ⓼ ⏩ (Track Skip)
- ⓽ ⏩ (Search)
- ⓾ ▷ (Play)
- ⓿ CDR
- ⓿ ◻ (Stop)

■ Loading the batteries in the remote control

1. Remove the battery compartment cover on the back of the remote control.
2. Insert 2 batteries (AA, UM-3 or R6 type) according to the polarity markings on the inside of the battery compartment.
3. Close the cover until it snaps into place.

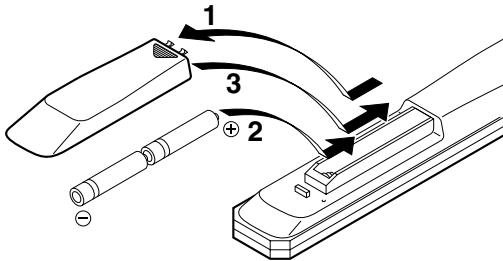

■ Battery replacement

If you find that the remote control must be used closer to this unit than usual, the batteries are weak. Replace both batteries with new ones.

■ Notes on batteries

- Use only AA, UM-3, or R6 type batteries for replacement.
- Do not mix a new battery with a used one.
- A rechargeable battery cannot be used.
- Do not mix different types of battery.
- Do not attempt to short out the batteries by directly connecting the plus (+) and the minus (-) with a piece of metal.
- Remove the batteries if the remote control will not be used for an extended period of time.
- If the batteries leak, dispose of them immediately, taking care not to touch the battery fluid. If the battery fluid comes into contact with your eyes, mouth, or skin, rinse it off with water immediately, and consult a doctor. Clean the battery compartment thoroughly before installing new batteries.

■ Remote control operation range

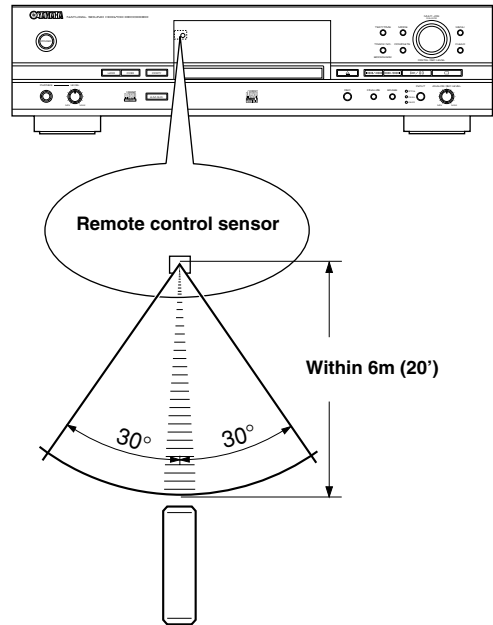

Cautions

- If operation of this unit by the remote control creates any malfunction in any other components, change the placement of the component.
- Do not spill any liquid on or drop the remote control. Do not place it near a heater or in the bathroom where the temperature and humidity become high.
- Make sure the remote control sensor is not exposed to direct sunlight or strong lights. If it is, it may not function correctly.

Display

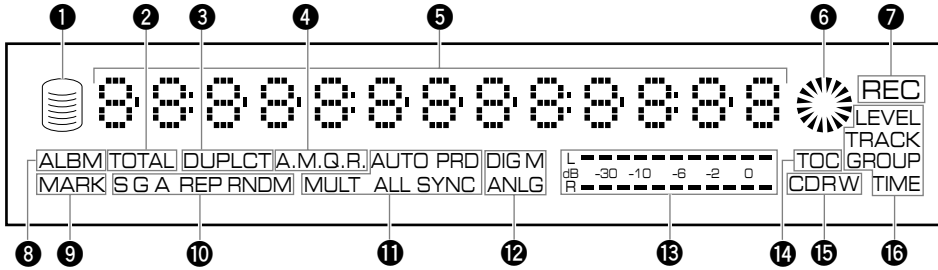

- ① HDD mark
- ② TOTAL indicator
- ③ DUPLCT indicator
- ④ A.M.Q.R. indicator
- ⑤ Information display
- ⑥ CDR mark
- ⑦ REC indicator
- ⑧ ALBM indicator
- ⑨ MARK indicator
- ⑩ Playback mode/play style indicator
 - S indicator
 - G indicator
 - A indicator
 - REP indicator
 - RNDM indicator
- ⑪ Recording/copying mode indicator
 - AUTO indicator
 - PRD indicator
 - MULT indicator
 - ALL indicator
 - SYNC indicator
- ⑫ Copying method indicator
 - DIG indicator
 - M indicator
 - ANLG indicator
- ⑬ Level meter
- ⑭ TOC indicator
- ⑮ CD-RW indicator
- ⑯ MULTI JOG status indicator
 - LEVEL indicator
 - TRACK indicator
 - GROUP indicator
 - TIME indicator

Display Information

The display located in the center of this unit provides the information about the drive (HDD or CDR drive) selected. Each time **TEXT/TIME** is pressed, the display changes according to the operation.

■ Display while playing the data on the HDD

Group number, track number and elapsed time of the track being played



Group number, track number and remaining time of the track being played

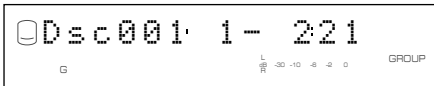

Group number and group total time



Group number and group remaining time



Group title or track title

Group title



Track title



The group title with the **GROUP** indicator and the track title with the **TRACK** indicator are switched by pressing the **MULTI JOG** knob.

■ Display while recording onto the HDD

Disc number, track number and elapsed time of the track being recorded

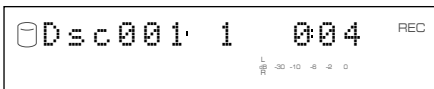

Disc number and total recorded time on the disc

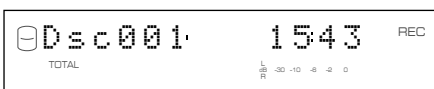

■ Display while playing a CD

Track number and elapsed time of the track being played



Track number and remaining time of the track being played

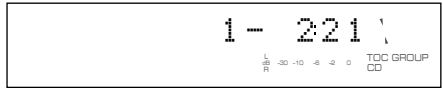

Disc total time



Disc remaining time

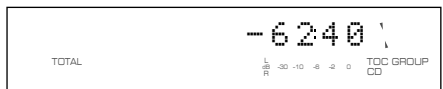

CD TEXT (when available)

Disc title



Track title



The group title with the **GROUP** indicator and the track title with the **TRACK** indicator are switched by pressing the **MULTI JOG** knob.

■ Display while recording onto a CD-R or CD-RW disc

Track number and elapsed time of the track being recorded

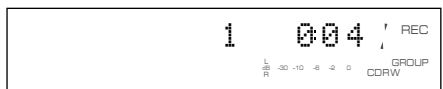

Total recorded time on a disc



Total recordable time on a disc

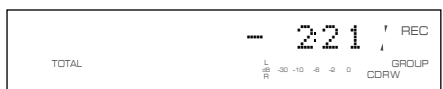

Rear Panel

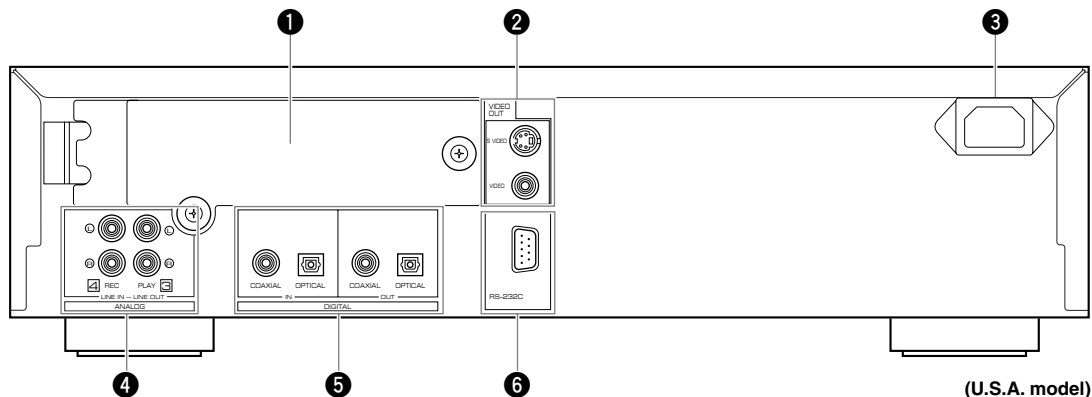

- ❶ HDD slot
- ❷ **VIDEO OUT** jacks
 - S VIDEO jack
 - VIDEO jack
- ❸ AC inlet
- ❹ **ANALOG** jacks
 - ANALOG LINE IN (REC) jacks
 - ANALOG LINE OUT (PLAY) jacks
- ❺ **DIGITAL** jacks
 - DIGITAL IN (COAXIAL) jack
 - DIGITAL IN (OPTICAL) jack
 - DIGITAL OUT (COAXIAL) jack
 - DIGITAL OUT (OPTICAL) jack
- ❻ RS-232C terminal

CONNECTIONS

Turn off the power of this unit and the other components, and unplug them from the wall outlet before making any connections.

■ Digital connections

- This unit has the **DIGITAL OPTICAL** jacks and **DIGITAL COAXIAL** jacks. Connect either the **DIGITAL OPTICAL** jacks, or the **DIGITAL COAXIAL** jacks according to the component to be connected.
- Using the optical fiber cable, connect the **DIGITAL IN (OPTICAL)** jack on this unit to the digital optical output jack on the other component, and the **DIGITAL OUT (OPTICAL)** jack on this unit to the digital optical input jack on the other component.
- When using the **DIGITAL IN/OUT (COAXIAL)** jacks, make connections with coaxial cables. Connect the **DIGITAL IN (COAXIAL)** jack on this unit to the digital coaxial output jack on the other component, and the **DIGITAL OUT (COAXIAL)** jack on this unit to the digital coaxial input jack on the other component.

■ Analog connections

- Make sure to connect the **L** (left) and **R** (right) input and output jacks on this unit to the correct **L** (left) and **R** (right) input and output jacks on the other component.
- Connect the **ANALOG LINE IN (REC)** jack on this unit to the analog output jack on the other component, and the **ANALOG LINE OUT (PLAY)** jack on this unit to the analog input jack on the other component.
- The **ANALOG LINE IN (REC)/LINE OUT (PLAY)** jacks on this unit are numbered ❸ and ❹ respectively. Connect these jacks to the jacks with the same numbers when connecting this unit to a Yamaha amplifier or receiver.
- To connect the turntable directly to this unit, first connect it to the phono equalizer and then connect to the **ANALOG LINE IN (REC)** jacks on this unit.

Notes

- When you play the data on the HDD or CDs, signals are output both from the **ANALOG LINE OUT (PLAY)** jack and from the **DIGITAL OUT (OPTICAL/COAXIAL)** jacks.
- Signals that are output through the **DIGITAL OUT (OPTICAL)** jacks or the **DIGITAL OUT (COAXIAL)** jacks while playing the data on the HDD do not have information about the track markers. Therefore if these signals are recorded by an MD player, the track markers may not be placed correctly on the recorded MD disc.

■ Connecting a monitor

- You can display the list of groups or tracks to be played, copying/recording settings or the list of setting items on the monitor by connecting the monitor to this unit. Connect the **S VIDEO** jack or the **VIDEO** jack whichever available on your monitor.
- Use a commercially available S-video cable to connect the **S VIDEO** jack on this unit and the S-video input jack on the monitor.
- Use an included video pin cable to connect the **VIDEO** jack on this unit and the composite video jack on the monitor.
- Arrow marks (→) in the illustration below indicate the direction of the audio signal.

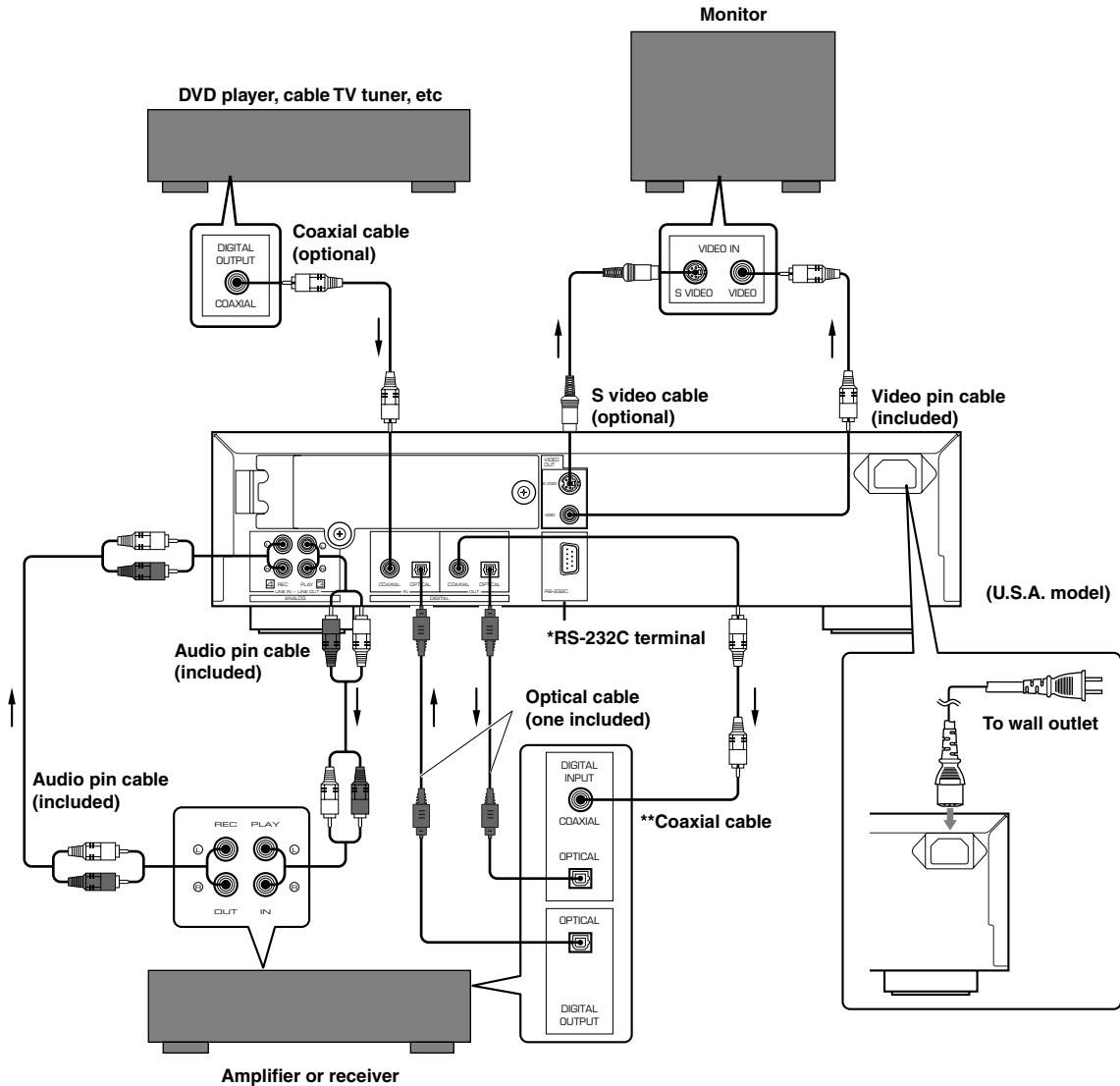

*This terminal is for connection of the personal computer. Information about the connection software is to be announced on the YAMAHA website (see page 93).

**For U.S.A. model, one coaxial cable with ferrite core is included. Be sure to connect to the DIGITAL OUT (COAXIAL) jack with this cable, directing the side with ferrite core to this unit.

■ Connecting the power cable

Plug the power cable into the AC inlet when all connections are complete, and then plug in the power cable to the wall outlet.

[Europe, U.K. and Australia models]

Plug in this unit to the wall outlet.

COPYING FROM A CD ONTO THE HDD

Copying All Tracks on a CD

You can copy all tracks on a CD onto the HDD.

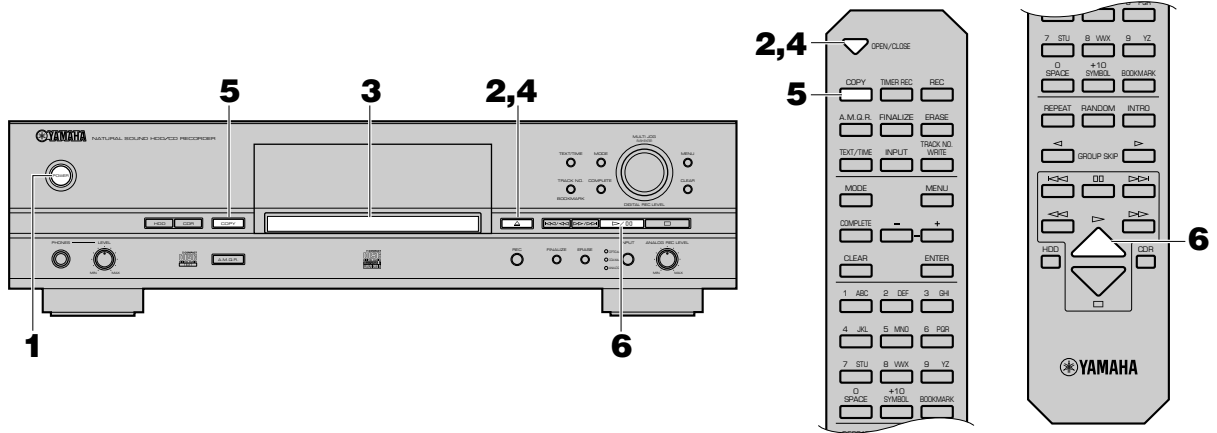

1. Turn on the power of this unit by pressing POWER on the front panel.

The message “WELCOME TO YAMAHA HDD/CD SYSTEM” appears on the display. After the message is displayed, this unit is ready for operation.

2. Press \triangle (OPEN/CLOSE on the remote control) to open the disc tray.

3. Load the CD to copy from on the disc tray.

Place a CD correctly aligned in the recessed area of the disc tray with its label side facing up.

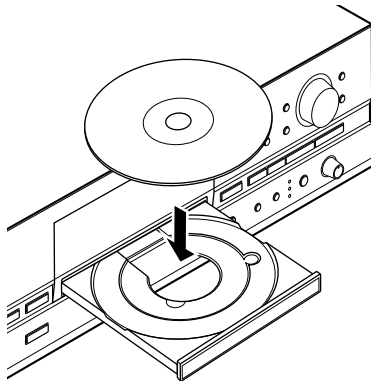

4. Press \triangle (OPEN/CLOSE on the remote control) to close the disc tray.

Note

- The disc tray can be also closed by pressing the front edge of the disc tray gently. If the disc tray is closed in this way, this unit starts playback of a CD. Press \square to stop playback.

This unit starts reading the information (type and capacity of the CD) when the CD is loaded. It takes approximately 10 to 15 seconds to complete the reading. The following message appears on the display during the reading.



When reading the information has been completed, the display changes as follows, and this unit becomes ready for operation.

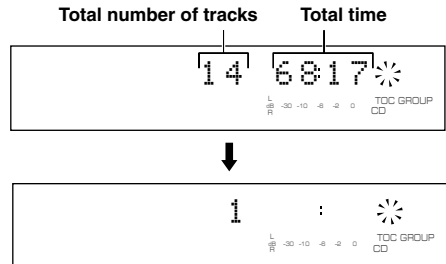

5. Press COPY once.

The following message appears on the display, and this unit enters the copy standby mode. Copying has not been started yet at this stage.

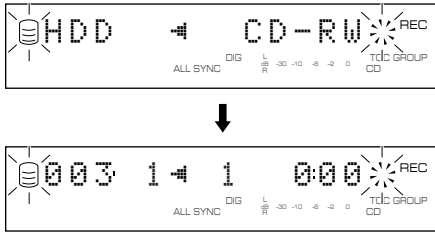

CDTEXT

If the CD to be copied contains CD TEXT that can be copied, CD TEXT is automatically copied when the CD is copied onto the HDD.

Output of the signals during copying

- During copying at 1x speed, signals are output both from the **ANALOG LINE OUT (PLAY)** jack and from the **DIGITAL OUTPUT (OPTICAL/COAXIAL)** jacks.
- During copying at 2x speed, signals are output only from the **ANALOG LINE OUT (PLAY)** jack.
- During copying at 4x or more speed, signals are output neither from the **ANALOG LINE OUT (PLAY)** jack nor the **DIGITAL OUTPUT (OPTICAL/COAXIAL)** jacks.

6. Start copying.

Press \triangleright / \square (\triangleright on the remote control) to start copying.

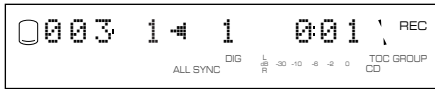

The copying conditions (initial settings) are as follows:

- Copy Method: "Digital Copy"
- Copy Level: 0dB
- Copy Speed: "Best Effort"

To change the settings, see "Copying menu setting" on page 18.

Notes

- It takes a few seconds for this unit to become ready to start copying after \triangleright / \square (\triangleright on the remote control) has been pressed.
- This unit may create some vibration and rotation noise while performing the copying process by rotating a CD at high speed. If this problem occurs, lower the copying speed to decrease the vibration and rotation noise. (See "Copy Speed" on page 19.)

To cancel copying, press \square .

When copying has been completed, the operation of the HDD and the CD automatically stops.

Copying Favorite Tracks on the CD

You can copy your favorite tracks on a CD onto the HDD.

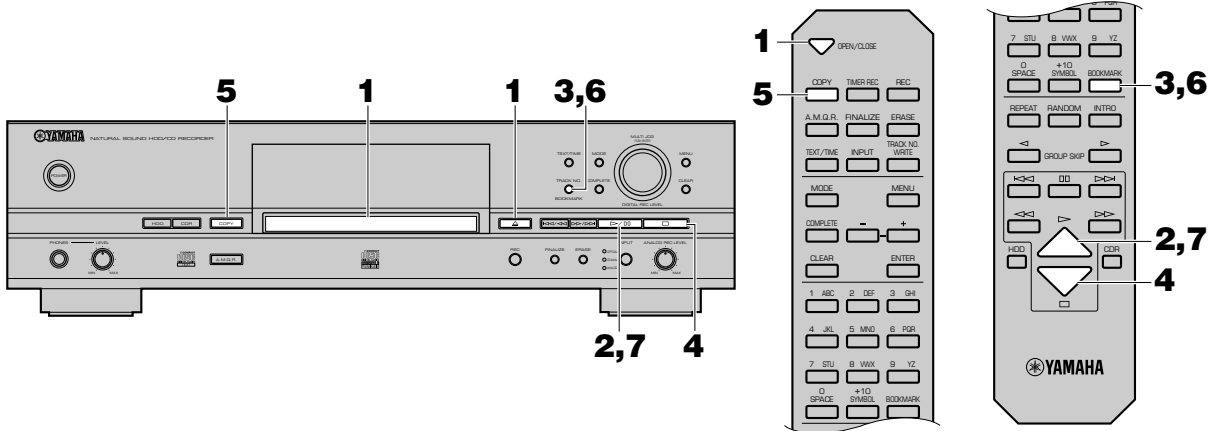

1. Load the CD to copy from on the disc tray.

Press \triangle (OPEN/CLOSE on the remote control) to open the disc tray, and place a CD with its label side facing up. Then press \triangle (OPEN/CLOSE on the remote control) to close the disc tray.

2. Start playback of the CD.

Press \triangleright/\square (\triangleright on the remote control) to start playback. Playback is started from the beginning of the first track.

3. Press TRACK NO./BOOKMARK (BOOKMARK on the remote control) while your favorite track is being played.

The **MARK** indicator lights on the display.



Press \lll/\lll or \ggg/\ggg (\lll or \ggg on the remote control) to skip tracks, and repeat above operation.

To cancel a bookmark

Press **TRACK NO./BOOKMARK** (BOOKMARK on the remote control) to cancel the bookmark during playback of the track. The **MARK** indicator turns off on the display.

4. When the bookmark have been placed to all favorite tracks, press \square to stop playback.

Tracks are listed and stored in order that the bookmarks have been placed.

To cancel all bookmarks

Press **CLEAR** as pressing **TRACK NO./BOOKMARK** on the front panel while this unit is in the stop mode. "Bookmark Clr" appears on the display, and all bookmarks are canceled.

Note

- The bookmark placed to the track on the CD will be canceled if the disc tray is open, or the power of this unit is turned off.

5. Press COPY once.

This unit enters the copy standby mode. Copying has not been started yet at this stage.

6. Press TRACK NO./BOOKMARK (BOOKMARK on the remote control).

The list of the track that the bookmark is placed to is selected as the group to be copied (the **MARK** indicator lights on the display). Press **TRACK NO./BOOKMARK** (BOOKMARK on the remote control) again to return to the normal copy standby mode.

7. Start copying.

Press \triangleright/\square (\triangleright on the remote control) to start copying.

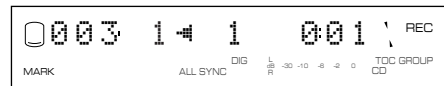

Notes

- It takes a few seconds for this unit to become ready to start copying after \triangleright/\square (\triangleright on the remote control) has been pressed.
- This unit may create some vibration and rotation noise while performing the copying process by rotating a CD at high speed. If this problem occurs, lower the copying speed to decrease the vibration and rotation noise. (See "Copy Speed" on page 19.)

To cancel copying, press \square .

When copying has been completed, the operation of the HDD and the CD automatically stops.

Advanced Operations

■ Making an additional copying onto an already recorded disc

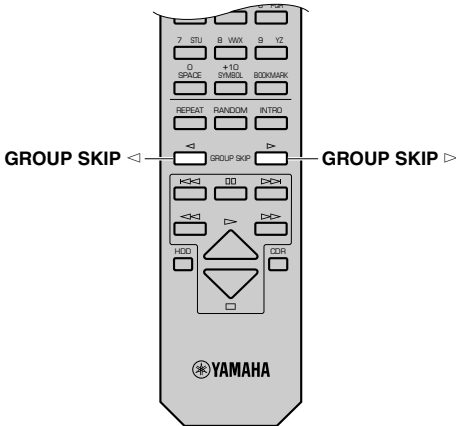
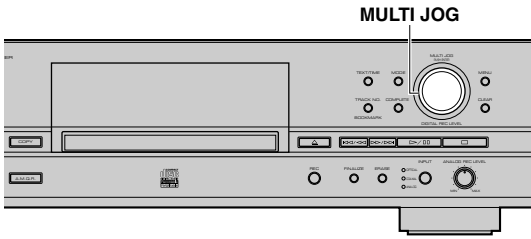

When the copying onto the HDD, you can select the disc on the HDD to make copy on. Rotate the **MULTI JOG** knob (press **GROUP SKIP** ◀/◻/▶ **GROUP SKIP** ▶ on the remote control) to select the disc number to make the copy while this unit is in the copy standby mode.

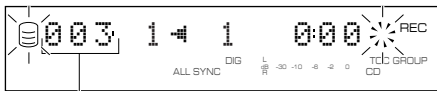

Disc number to make the copy on

Notes

- If the disc number is not selected, copying will be made on the disc with the smallest number available on the HDD.
- When a disc number with recorded tracks is selected, new recordings will be added to the end of the last track that has been previously recorded.

■ Setting the copying mode

This unit provides various copying modes. Choose the one that suits your needs.

Initial setting: All Synchro

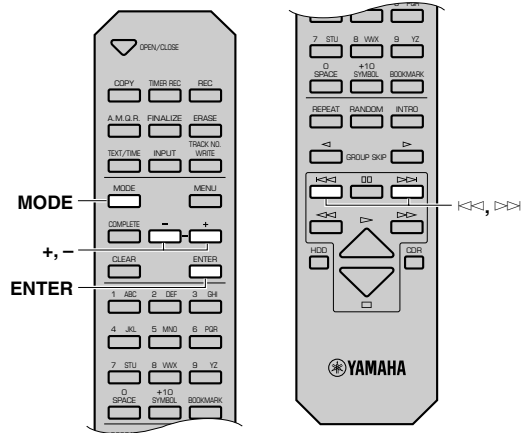
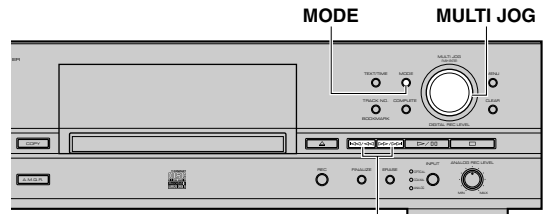

1. Press MODE while this unit is in the copy standby mode.

You can select the copying mode.

2. Rotate the MULTI JOG knob (press +/- on the remote control) to select the copying mode.

Choose one of the modes listed below.

All Synchro (All-synchronized copying mode)

This mode copies all of the material from a single audio source at the same time as the source programs are being played. Track markers are automatically placed between the tracks being recorded.

Multi Synchro (Multi-synchronized copying mode)

This mode copies the set number of tracks at the same time as the source programs are being played. The number of tracks to be recorded can be set in the range of 1 to 99 tracks. This mode is convenient to record a mix of tracks from different sources.

3. Press the MULTI JOG knob (ENTER on the remote control) to confirm the copying mode selected.

If "All Synchro" is confirmed, this unit returns to the copy standby mode.

If "Multi Synchro" is confirmed, the following message appears on the display. Go to step 4.



4. Select the number of tracks by rotating the MULTI JOG knob (pressing +/- on the remote control).

The number can be selected in the 1 to 99 tracks range.

5. Press the MULTI JOG knob (ENTER on the remote control) to confirm the number selected.

This unit returns to the copy standby mode.

6. Select the track to start copy from by pressing <<</>>> or >>>/<<< (<<< or >>> on the remote control).

■ Copying menu setting

You can make detailed settings on the menu for your copying. Follow the steps described below for menu setting.

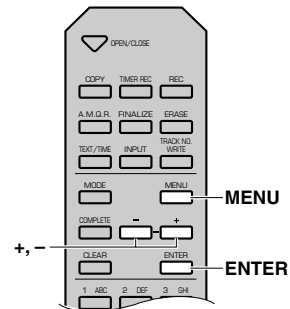
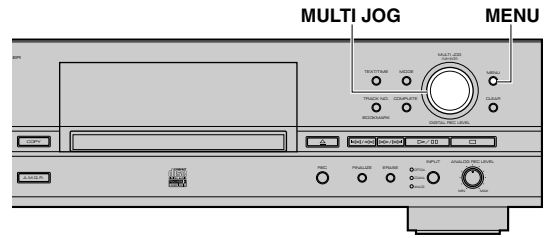

1. Press MENU while this unit is in the copy standby mode.

You can start setting the copying menu.

2. Select the menu item to be set by rotating the MULTI JOG knob (pressing +/- on the remote control).

The copying menu contains 3 items as follows:

- Copy Method (setting the copying method)
- Copy Level (setting the copying level)
- Copy Speed (setting the copying speed)

3. Press the MULTI JOG knob (ENTER on the remote control) to confirm the menu item to be adjusted.

4. Adjust the parameter for each item by rotating the MULTI JOG knob (pressing +/- on the remote control).

See the further steps for detailed instructions on parameter adjustment for each item.

5. Press the MULTI JOG knob (ENTER on the remote control) to confirm the setting when adjustment has been completed.

6. Press MENU to close the menu.

This unit returns to the copy standby mode.

Copy Method

Setting of the copying method. Copying may fail if the setting for “Copy Method” is not correctly made.



Initial setting: Digital Copy

Digital Copy

This method always makes digital copies. Copying is not possible if the tracks are copy protected by the SCMS standard (see page 5).

Auto Dig/Anlg

Digital and analog copying are automatically switched depending on the track. If digital copying is prohibited by the SCMS standard (see page 5), an analog copy is made. For those tracks that can be digitally copied, a digital copy is made.

Analog Copy

This method always makes analog copies.

Notes

- In analog copying, the data may be copied at a lower sound level.
- The setting is stored in the memory and applies to future copying.

Copy Level

Setting of the sound level for copying. Sound level adjustment is not normally necessary. However it is possible to adjust the copying sound level to suit you needs.



The following message appears on the display when “Copy Level” setting is confirmed in step 3 for “Copying menu setting” on page 18.



1. Adjust the copying sound level by rotating the MULTI JOG knob (pressing +/- on the remote control).

Adjustment is possible in the -12dB to +12dB range by 0.4dB steps.

2. Press the MULTI JOG knob (ENTER on the remote control) to confirm the copying level setting.

Notes

- Level adjustment is not possible during copying.
- If the red part on the peak level meter lights at the loudest sound levels, stop copying to adjust the copying level, and then resume copying.

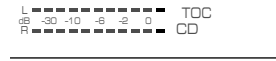

- If the level is adjusted, copying is made at maximum 2x speed.

Copy Speed

Setting of the copying speed.

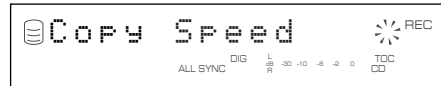

Initial setting: Best Effort

Best Effort

Copying is made at the maximum speed possible depending on the “Copy Method” and “Copy Level” settings.

- When “Digital Copy” is selected: maximum 10x speed
- When “Auto Dig/Anlg” is selected: maximum 2x speed
- When “Analog Copy” is selected: maximum 2x speed

1x Copy

Copying is always made at 1x speed despite the “Copy Method” and “Copy Level” settings.

2x Copy

Copying is always made at 2x speed despite the “Copy Method” and “Copy Level” settings.

Notes

- If there are scratches or dust on the CD, the copy speed may drop automatically even when “Best Effort” is selected.
- The setting is stored in the memory and applies to future copying.

Recording from the Digital Components

You can make recordings from the component such as a cable TV tuner and a DVD player digitally connected to this unit.

Note

- Recording onto the HDD is made in the unit called “disc”. The maximum length of one disc on the HDD is 99 minutes 59 seconds. If the recording has been made exceeding the maximum length, the recording will be made continuously to the next available disc.

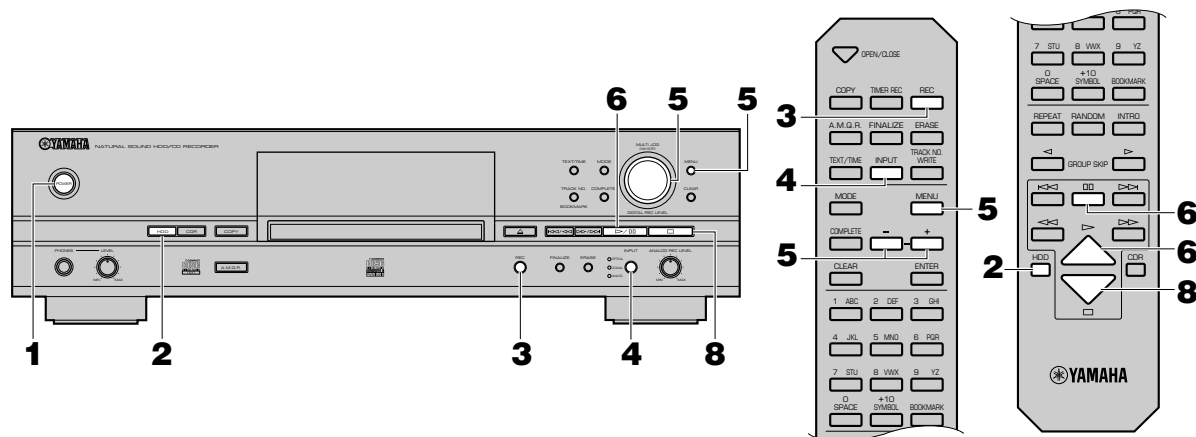

1. Turn on the power of this unit by pressing POWER on the front panel.

The message “WELCOME TO YAMAHA HDD/CD SYSTEM” appears on the display. After the message is displayed, this unit is ready for operation.

2. Press HDD to select the HDD.

3. Press REC.

The **HDD** mark flashes, and the disc and track numbers to be recorded are indicated on the display. Recording has not been started yet at this stage. (Recording pause mode)

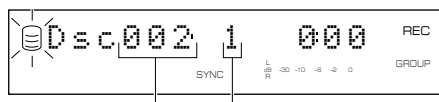

Disc number to be recorded Track number to be recorded

4. Select the input source to be recorded.

Press **INPUT** repeatedly until the **OPTICAL** or **COAXIAL** indicator lights up.

5. Adjust the recording level.

The adjustment of the digital recording level is not normally necessary. However it is possible to adjust the recording level to suit your needs.

Play the loudest passage (highest sound level) of the source to be recorded.

By pressing **MENU**, the display changes for the level adjustment.

Rotate the **MULTI JOG** knob (press **+/-** on the remote control) to adjust the recording level. When the adjustment is completed, press **MULTI JOG** knob (**ENTER** on the remote control) to confirm the adjusted recording level.

Note

- Adjust the recording level so that the red part on the peak level meter does not light at the loudest sound levels.

See “Adjusting the Recording Level” on page 24 for details.

6. Start recording.

Press **>/00** (**>** or **00** on the remote control) to start recording.

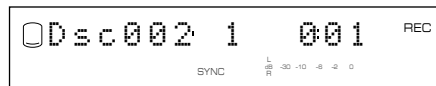

7. Start playing the source.

Press **>/00** (**00** on the remote control) to stop recording temporarily. The **HDD** mark flashes and the track number is advanced to the next.

Press **>/00** (**>** or **00** on the remote control) to resume recording.

8. Press **□** to stop recording.

The first track number of the disc at which recording has been stopped is indicated on the display.

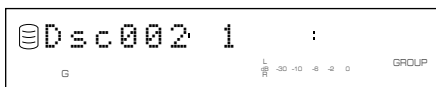

IMPORTANT

- Never turn off the power of this unit during recording. Recording may not be correctly made, or the data on the HDD may be damaged.
- During recording, make sure that this unit is not subjected to shock or vibration as the HDD may be damaged.

Recording from the Analog Components

You can make recordings from the component such as a cassette deck and a turntable connected to this unit.

Note

- Recording onto the HDD is made in the unit called “disc”. The maximum length of one disc on the HDD is 99 minutes 59 seconds. If the recording has been made exceeding the maximum length, the recording will be made continuously to the next available disc.

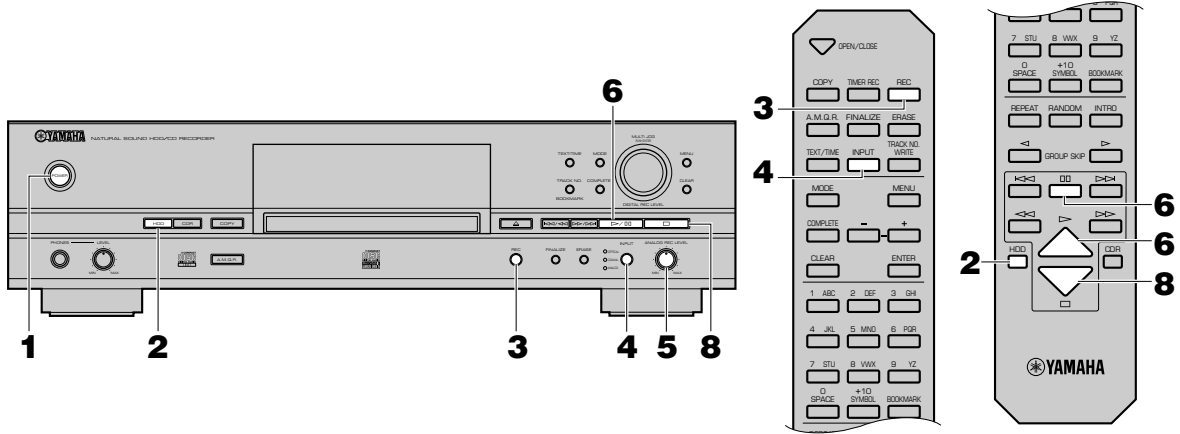

- 1. Turn on the power of this unit by pressing POWER on the front panel.**
- 2. Press HDD to select the HDD.**
- 3. Press REC.**
This unit enters the recording pause mode.



- 4. Select the input source to be recorded.**
Press **INPUT** repeatedly until the **ANALOG** indicator lights up.
- 5. Adjust the recording level.**
Play the loudest passage (highest sound level) of the source to be recorded, and rotate the **ANALOG REC LEVEL** control to adjust the recording level.

Note

- Adjust the recording level so that the red part on the peak level meter does not light at the loudest sound levels.
- See “Adjusting the Recording Level” on page 24 for details.

- 6. Start recording.**
Press \triangleright/\square (\triangleright or \square on the remote control) to start recording.



- 7. Start playing the source.**
Press \triangleright/\square (\square on the remote control) to stop recording temporarily. The **HDD** mark flashes and the track number is advanced to the next.
Press \triangleright/\square (\triangleright or \square on the remote control) to resume recording.
- 8. Press \square to stop recording.**
The first track number of the disc at which recording has been stopped is indicated on the display.

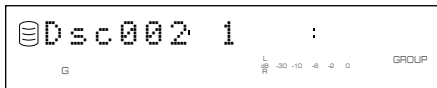

IMPORTANT

- Never turn off the power of this unit during recording. Recording may not be correctly made, or the data on the HDD may be damaged.
- During recording, make sure that this unit is not subjected to shock or vibration as the HDD may be damaged.

Recording Using an External Timer

■ Notes on recording time setting

- This unit is not equipped with the clock function. Use an external timer when making a timer recording.
- It may take 30 seconds to 1 minute after the power of this unit is turned on by an external timer until an actual recording starts. (This length of time is subject to change depending on the condition.) During this time, no recording is made. Therefore set the time that is 2-minute earlier than the starting time of the program to be recorded for turning on this unit.
- As a characteristic of an HDD recorder, it is necessary to store information to control audio data as well as audio data itself. This information is normally recorded when recording is stopped. Therefore if the power of this unit is turned off before recording is stopped, no information to control audio data and no audio data are stored. Set the time that is longer than 3-minute after the program to be recorded finishes for turning off this unit by an external timer.
- Set the time that is 2-minute longer than actual recording time for the total recording time.

Following chart indicates the time flow when this unit makes timer recordings.

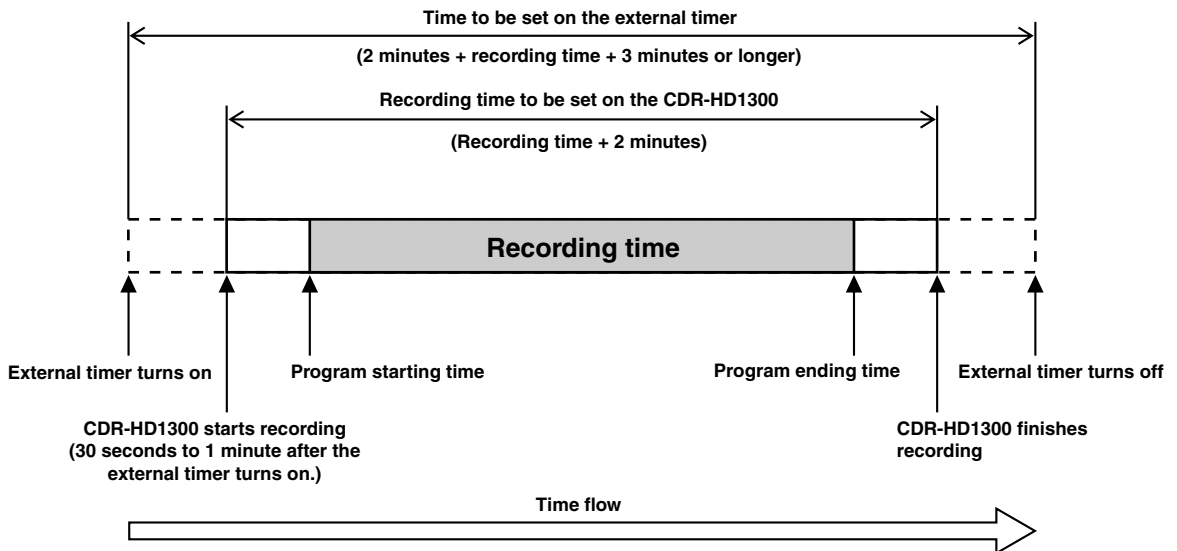

Example: To record the program that starts at 9:00 and ends at 10:00.

- Set the external timer to be turned on at 8:58.
- Set the external timer to be turned off after 10:03.
- Set 1 hour 2 minutes for the total recording time on this unit.

Notes

- Actual recorded material includes a little more than the set amount of time at both beginning and end of the recording. Delete unnecessary parts using the editing operation.
- Recording will be stopped if copy protected digital signals are input while timer recording is being made.
- If you set the total recording time over 99 minutes 59 seconds, recording will be made extending several discs. To play the recorded materials sequentially, select "Style All" as the play style. See "Setting the Play Style" on page 80.

See next page for the setting procedure.

■ Setting for a timer recording

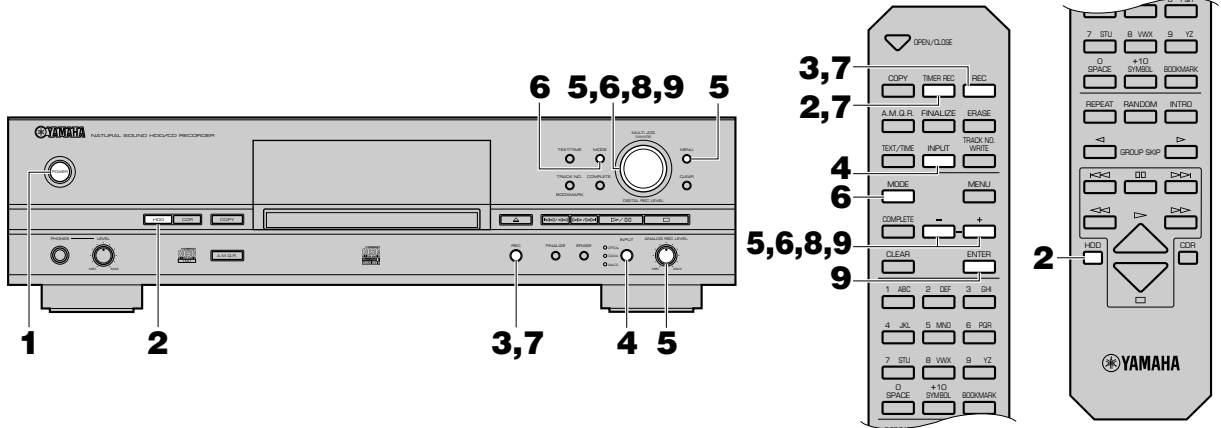

1. Turn on the power of this unit by pressing **POWER** on the front panel.

2. Press **HDD** to select the HDD.

Notes

- A timer recording cannot be made when recording onto a CD-R or CD-RW disc.
- You can directly go to step 7 to set the total time of timer recording by pressing **TIMER REC** on the remote control.

3. Press **REC**.

This unit enters the recording pause mode.

4. Select the input source to be recorded.

Press **INPUT** to select the input source from among **OPTICAL**, **COAXIAL**, and **ANALOG**.

5. Adjust the recording level.

See “Adjusting the Recording Level” on page 24.

6. Select a recording mode.

Select one of “Manual” (manual recording), “Track Synchro” (track-synchronized recording) or “Auto Period” (auto-period recording). Other modes cannot be selected when timer recording is made.

7. Press and hold **REC** for approximately 3 seconds (press **TIMER REC** on the remote control).

Following message appears on the display. Then set the total amount of time of timer recording.

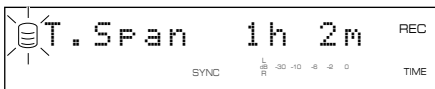

8. Rotate the **MULTI JOG** knob (press +/- on the remote control) to set the total time of timer recording.

Total time can be set as long as the recordable maximum time by 1-minute step.

9. Press the **MULTI JOG** knob (**ENTER** on the remote control) to confirm the total time of timer recording.

“Timer Standby” appears on the display.

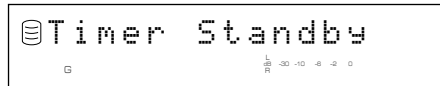

To cancel timer recording setting, press \square .

10. Leave the power of this unit on. Turn off the power of this unit by the external timer.

If the power of this unit is turned on by the external timer, “Timer Standby” flashes for approximately 5 seconds. Then recording starts according to the setting.

Note

- Once timer recording is set, recording starts every time the power of this unit is turned on. To cancel the setting, press \square while “Timer Standby” is flashing, or while recording is being made.

Adjusting the Recording Level

There is an adjusting procedure for each input source to be recorded as explained below. Choose the one for your input source and follow the steps.

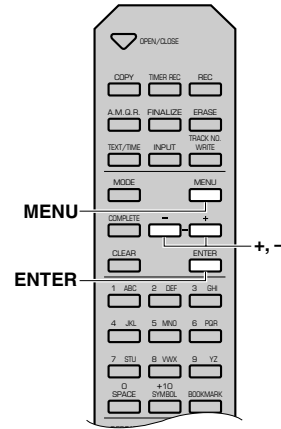
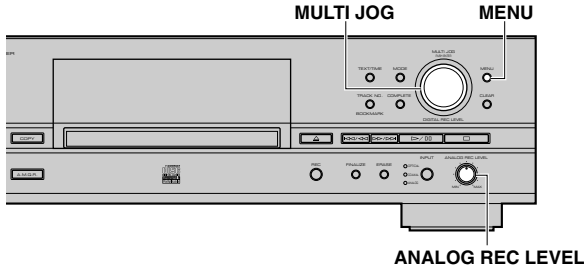

■ When recording a digital input source

The digital recording level is set to 0dB, the level of the input source, as an initial setting. Further adjustment is not normally necessary. However it is possible to adjust the recording level to suit your needs.

1. Press MENU while this unit is in the recording pause mode.

The following message appears on the display.

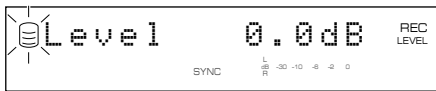

2. Play the loudest passage (highest sound level) of the source to be recorded.

3. Rotate the MULTI JOG knob (press +/- on the remote control) to adjust the recording level.

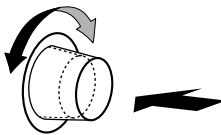

Adjustment is possible in the -12dB to +12dB range by 0.4dB steps.

Adjust the recording level so that the red part on the peak level meter does not light at the loudest sound levels.



4. Press the MULTI JOG knob (ENTER on the remote control) to return to the previous display.

Notes

- The recording level can be adjusted while this unit is in either the recording or recording pause mode. Once recording has been stopped, the recording level is reset to 0dB.
- Adjustment of the recording level can be canceled by pressing **MENU** when the level is adjusted in the recording pause mode.
- The recording level is set to 0dB by pressing **CLEAR** when the level is adjusted in the recording pause mode.

■ When recording an analog input source

1. Play the loudest passage (highest sound level) of the source to be recorded.

2. Adjust the recording level by rotating the ANALOG REC LEVEL control.

Rotate the control clockwise to increase the level and counterclockwise to decrease the level.

Adjust the recording level so that the red part on the peak level meter does not light at the loudest sound levels.

Note

- The recording level can be adjusted while this unit is in either the recording or recording pause mode.

Advanced Operations

■ Making an additional recording onto an already recorded disc

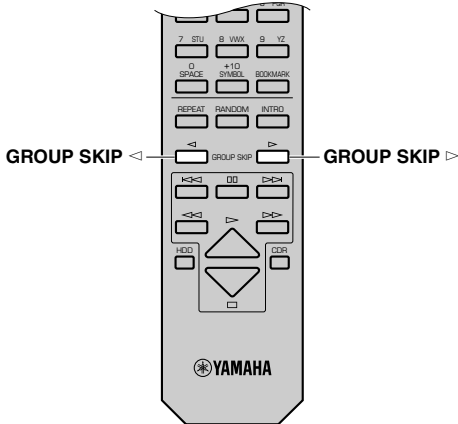
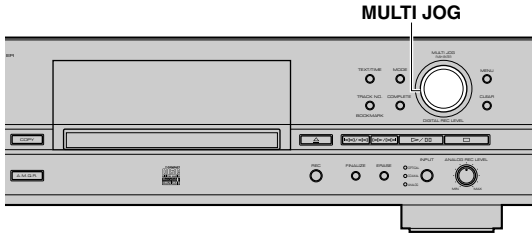

When recording onto the HDD, you can select the disc on the HDD for your recording. Rotate the **MULTI JOG** knob (press **GROUP SKIP** \triangleleft /**GROUP SKIP** \triangleright on the remote control) to select the disc number on which recordings are to be made while this unit is in the recording pause mode.

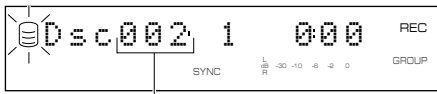

Disc number on which recordings are to be made

Notes

- When no disc number is selected, recordings are made onto the disc with the smallest number available on the HDD.
- When a disc with recorded tracks is selected, new recordings are added to the end of the previous recordings.

■ Setting the recording mode

This unit provides various recording modes. Choose the one that suits your needs.

Initial setting: Track Synchro

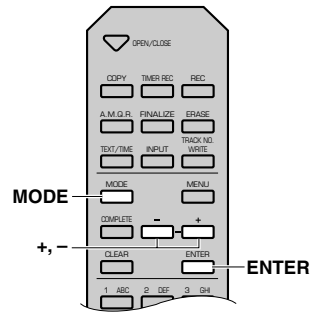
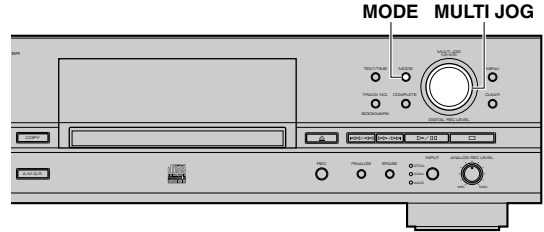

1. Press **MODE** while this unit is in the recording pause mode.

The recording mode can be selected.

2. Rotate the **MULTI JOG** knob (press **+/-** on the remote control) to select the recording mode.

Choose one of the modes listed below.

Manual (Manual recording mode)

All the recording operations including starting, stopping and track marking are performed manually.

Track Synchro (Track-synchronized recording mode)

Starting and stopping are performed manually. Track markers are automatically placed between the tracks being recorded.

Multi Synchro (Multi-synchronized recording mode)

This mode records the set number of tracks at the same time as the source programs are being played. The number of tracks to be recorded can be set in the range of 1 to 99 tracks. This mode is convenient to record a mix of tracks from different sources.

All Synchro (All-synchronized recording mode)

This mode records all of the material from a single audio source at the same time as the source programs are being played. Track markers are automatically placed between the tracks being recorded.

Auto Period (Auto-period recording mode)

This mode makes recording for the set amount of time while placing track markers at the set time interval. The length between track markers can be adjusted in the 10 seconds to 30 minutes range by 10-second steps. This mode is convenient to search for material recorded from FM broadcasts.

3. Press the MULTI JOG knob (ENTER on the remote control) to confirm the recording mode selected.

If “Manual”, “Track Synchro” or “All Synchro” is confirmed, this unit returns the recording pause mode.

If “Multi Synchro” is confirmed, following message appears on the display. Make a setting following steps 4 and 5.



If “Auto Period” is confirmed, following message appears on the display. Make a setting following steps 6 to 9.



4. Select the number of tracks by rotating the MULTI JOG knob (pressing +/- on the remote control).

The number can be set in the 1 to 99 tracks range.

5. Press the MULTI JOG knob (ENTER on the remote control) to confirm the number of tracks to be set.

This unit returns to the recording pause mode.

6. Select the time length between track markers by rotating the MULTI JOG knob (pressing +/- on the remote control).

The time length can be set in the 10 seconds to 30 minutes range by 10-seconds steps.

7. Press the MULTI JOG knob (ENTER on the remote control) to confirm the time length between the selected track markers.

The following message appears on the display. The total recording time can be set.



8. Select the total recording time by rotating the MULTI JOG knob (pressing +/- on the remote control).

9. Press the MULTI JOG knob (ENTER on the remote control) to confirm the total recording time.

This unit returns to the recording pause mode.

Notes

- When recording to the HDD in the auto period recording mode, the recording will be performed continuously to the next available disc if the time length between selected track markers exceeds the group remaining time.
- In the auto period recording mode, a time error can occur in a frame unit. Therefore, the time of each track or the group total time may not match the confirmed time length between selected track markers or the total recording time.

Setting a condition at synchronized recording

This unit automatically detects track intervals when recording is made in track-synchronized recording mode, multi-synchronized recording mode, or all-synchronized recording mode. You can set the condition for detecting track intervals. Setting items are as follows:

OPT TH Level

Sets the signal level that judges the signals input through the **DIGITAL IN (OPTICAL)** jack as “no signal”.

Initial setting: -50dB, Control range: -90 to -20dB

COAX TH Level

Sets the signal level that judges the signals input through the **DIGITAL IN (COAXIAL)** jack as “no signal”.

Initial setting: -50dB, Control range: -90 to -20dB

ANLG TH Level

Sets the signal level that judges the signals input through the **ANALOG LINE IN (REC)** jacks as “no signal”.

Initial setting: -40dB, Control range: -60 to -20dB

Int. Time

Sets the length of silence (“no signal”) that judges track intervals. When the set amount of silence continues, this unit judges it as a track interval and places a track marker.

Initial setting: 2.0 seconds, Control range: 0.5 to 5.0 seconds

End Duration

Sets the length of silence (“no signal”) that judges the end of playback when recording in the all-synchronized recording mode. When the set amount of silence continues, recording will be stopped.

Initial setting: 12.0 seconds, Control range: 2.0 to 60.0 seconds

Note

- Settings for “Int. Time” and “End Duration” apply to each input jack.

See next page for the setting procedure.

■ **Setting a condition for synchronized recording**

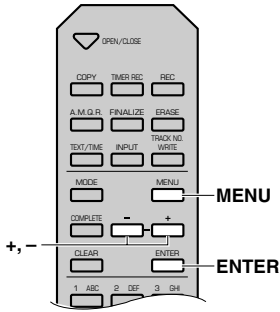
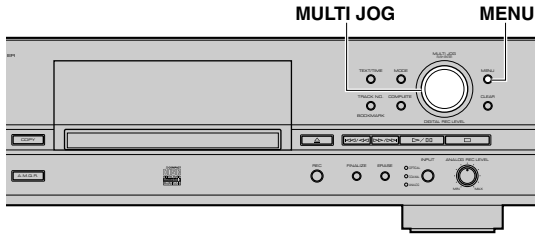

- 1.** Press **MENU** while this unit is in the stop mode.
Menu item selection appears on the display.
- 2.** Rotate the **MULTI JOG** knob (press +/- on the remote control) to select “Synchro Setup”.

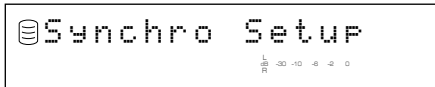

- 3.** Press the **MULTI JOG** knob (**ENTER** on the remote control).
Setting item selection appears on the display.
- 4.** Rotate the **MULTI JOG** knob (+/- on the remote control) to select a setting item.
- 5.** Press the **MULTI JOG** knob (**ENTER** on the remote control) to confirm the setting item.
If “OPT TH Level”, “COAX TH Level” or “ANLG TH Level” is confirmed, make a setting following steps 6 and 7.
If “Int. Time” or “End Duration” is confirmed, make a setting following 8 and 9.

- 6.** Rotate the **MULTI JOG** knob (press +/- on the remote control) to adjust the level.
Level can be set by 1dB step.

Example: To set “ANLG TH Level”

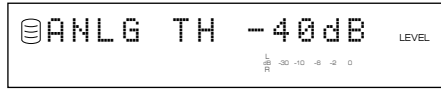

- 7.** Press the **MULTI JOG** knob (**ENTER** on the remote control) to confirm the level.
Setting item selection appears on the display.
- 8.** Rotate the **MULTI JOG** knob (+/- on the remote control) to set an interval.
“Int. Time” can be set by 0.5-second steps, and “End Duration” can be set by 1.0-second steps.

Example: To set “Int.Time”

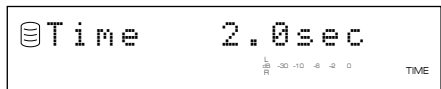

- 9.** Press the **MULTI JOG** knob (**ENTER** on the remote control) to set an interval.
Setting item selection appears on the display.

Press **MENU** twice to close the menu and return to the normal stop mode.

Manual track marking

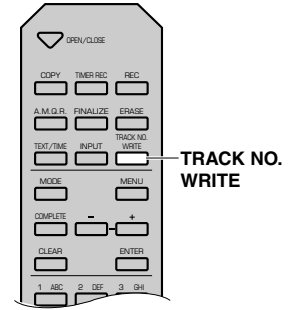
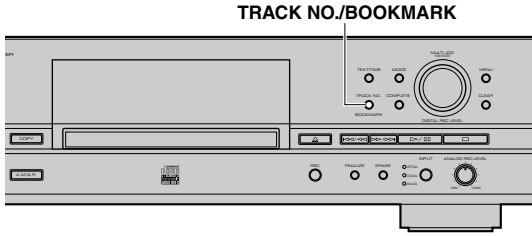

This unit can automatically place track markers. However you can also manually place track markers during your recording. (Manual track marking)

Press **TRACK NO./BOOKMARK (TRACK NO. WRITE** on the remote control) during your recording.

- A new track number is added at the location on the disc corresponding to the time **TRACK NO./BOOKMARK (TRACK NO. WRITE** on the remote control) is pressed.
- Manual track marking is possible after the recording has been performed for 5 seconds from the beginning of the track, and a disc cannot contain more than 99 tracks. Even if there is time remaining on the disc, further recording is impossible once 99 track markers have been placed.

Notes

- The track markers may not be placed properly even if the recording has been performed in the synchronized recording according to the type of the source devices. To avoid this problem, place the track markers manually.
- Manual track marking is possible even during synchronized recording.
- You can place the track markers to the tracks that have been recorded on the HDD by dividing the track. See “Track Divide” on page 46.

EDITING MENU ITEMS

You can make various editing operations on the albums, tracks and discs on the HDD. The editing menu is listed below.

| Menu item | | Menu content | Selectable during playback* | Page |
|------------|---------------|--|-----------------------------|--------|
| Album Edit | Album New | To create a new album | — | 31 |
| | Edit Stored | To edit an already created album | — | 31, 32 |
| | Album Copy | To copy other group as an album | — | 32 |
| | Album Rename | To change the album number | — | 33 |
| | Album Delete | To delete an album | ✓ | 33 |
| | Album Pack | To eliminate unused album numbers | — | 34 |
| | Album Title | To assign an album title | ✓ | 34, 35 |
| | Track Shuffle | To change the order of tracks in an album | ✓ | 35, 36 |
| | Track Level | To adjust the track level in an album | ✓ | 36, 37 |
| | Tr. Interval | To adjust each track interval in an album | ✓ | 38 |
| Track Edit | Track Rename | To change a track number | ✓ | 40 |
| | Track Adjust | To adjust the beginning of a track | ✓ | 41, 42 |
| | Track Erase | To erase a track | ✓ | 42 |
| | Part Erase | To erase the part of a track | ✓ | 43, 44 |
| | Track Combine | To combine a series of tracks | ✓ | 45 |
| | Track Divide | To divide one track into two | ✓ | 46, 47 |
| | Track Pack | To eliminate unused track numbers | — | 47 |
| | Add Fade In | To add fade-in to the beginning of a track | ✓ | 48, 49 |
| | Add Fade Out | To add fade-out to the end of a track | ✓ | 49, 50 |
| | Track Title | To assign a track title | ✓ | 50, 51 |
| Disc Edit | Disc Rename | To change a disc number | ✓ | 53 |
| | Disc Erase | To erase a disc | ✓ | 54 |
| | Disc Combine | To combine a series of discs | ✓ | 54, 55 |
| | Disc Divide | To divide one disc into two | ✓ | 55, 56 |
| | Disc Pack | To eliminate unused disc numbers | — | 56 |
| | Disc Title | To assign a disc title | ✓ | 57 |
| Undo | | To cancel the editing operation | — | 58 |

*The item that can be selected during playback is marked with the ✓ mark.

■ Selection of the item during playback

Selectable item is changed as follows according to the playback status.

- Items with the ✓ mark in “Album Edit” can be selected while an album is being played.

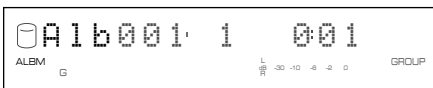

- Items with the ✓ mark in “Track Edit” can be selected while a disc with the **TRACK** indicator turned on.

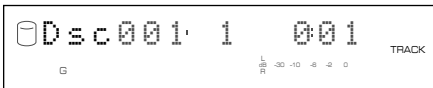

- Items with the ✓ mark in “Disc Edit” can be selected while a disc with the **GROUP** indicator turned on.



- No item can be selected while a bookmark is being played.

Notes

- To switch the **GROUP** indicator and the **TRACK** indicator, press the **MULTI JOG** knob.
- To switch the group to be played, rotate the **MULTI JOG** knob with the **GROUP** indicator turned on.

ALBUM EDITING

You can select the desired tracks from among the ones recorded on the HDD and store them as an album in this unit's memory. You can also edit the album afterwards.

Album Editing Operation

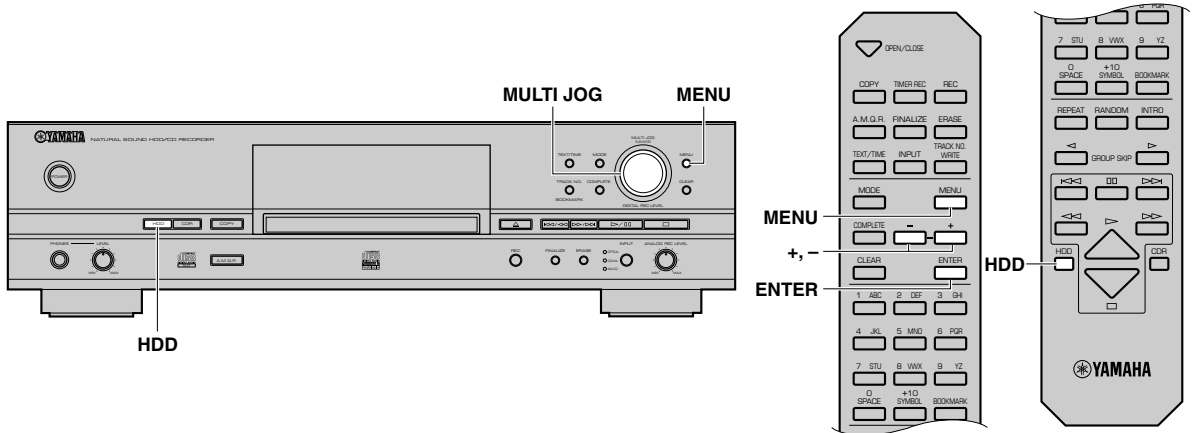

■ Editing during the stop mode

1. Press HDD to select the HDD.

2. Press MENU.

The display changes for the menu item selection.

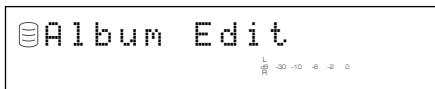

3. Press MULTI JOG knob (ENTER on the remote control).

The display changes for the editing the menu item selection.

4. Select the editing menu item to be set by rotating the MULTI JOG knob (pressing +/- on the remote control).

The followings are the album editing menu items.

- Album New
- Edit Stored
- Album Copy
- Album Rename
- Album Delete
- Album Pack
- Album Title
- Track Shuffle
- Track Level
- Tr. Interval

5. Press MULTI JOG knob (ENTER on the remote control).

The selected item is confirmed. Then editing operation can be started.

6. Start editing by following the setting steps (pages 31—38) for each item.

7. Press □ when all editing has been completed.

The display changes to the one when this unit was in the stop mode.

■ Editing during playback

1. Press MENU while the album to be edited is being played.

The display changes for the editing menu item selection.

2. Select the editing menu item to be set by rotating the MULTI JOG knob (pressing +/- on the remote control).

The followings are the album editing menu items.

- Album Delete
- Album Title
- Track Shuffle
- Track Level
- Tr. Interval

3. Press MULTI JOG knob (ENTER on the remote control).

The selected item is confirmed. Then editing operation can be started.

4. Start editing by following the setting steps (pages 31—38) for each item.

Notes

- If **MENU** is pressed during editing, entry of the selection is canceled, and then this unit returns to the following state;
 - This unit returns to the editing menu item selection if having started editing during the stop mode.
 - This unit returns to the playback if having started editing during the playback.
- If **□** is pressed during editing, all entry of the selection is canceled, and this unit returns to the stop mode.

Album New

You can create a new album by selecting the desired tracks from among the ones recorded on the HDD.

1. Select and confirm “Album New” in step 4 of “Editing during the stop mode” on page 30.

The following message appears on the display.

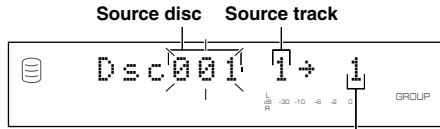

Track in the album to be created

The number of the source disc flashes.

2. Select the source disc by rotating the MULTI JOG knob (pressing +/- on the remote control).
3. Press the MULTI JOG knob (ENTER on the remote control) to confirm the source disc.
The number of the source track flashes.
Press **CLEAR** to cancel the confirmed selection.
4. Select the source track by rotating the MULTI JOG knob (pressing +/- on the remote control).
5. Press the MULTI JOG knob (ENTER on the remote control) to confirm the source track.

The track number of the album being created will be advanced to the next, and the display returns to the one shown in step 1. Repeat steps 2—5 to select other discs and tracks.

Press **CLEAR** to cancel the confirmed selection.

6. Press **COMPLETE**.

A new album is created with the selected tracks recorded on it. This unit returns to the editing menu item selection.

Notes

- You can switch the display by pressing **TEXT/TIME** while an album is being made:
 - If the title is assigned to the source disc or track, the title appears.
 - By pressing **TEXT/TIME** while the title is being displayed, the total time of the album being made appears for approximately 1 second, and the display returns to the one in step 1.
 - If no title is assigned to the source disc or track, the total time of the album being made appears for approximately 1 second, and the display returns to the one in step 1.
- You can create a new album using the tracks with bookmarks (see “Album Copy” on page 32). Also see “BOOKMARK” on page 59.

Edit Stored

You can add tracks to or delete tracks from an already created album.

1. Select and confirm “Edit Stored” in step 4 of “Editing during the stop mode” on page 30.

The following message appears on the display.

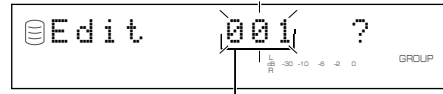

Album to be edited

The number of the album to be edited flashes.

2. Select the album to be edited by rotating the MULTI JOG knob (pressing +/- on the remote control).
3. Press the MULTI JOG knob (ENTER on the remote control) to confirm the album to be edited.

The following message appears on the display.

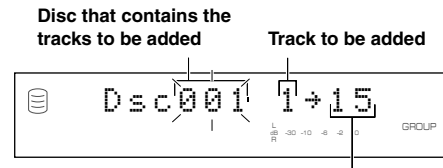

Track to be added or deleted

■ When adding new tracks

4. Select the track to be added by pressing <<</>>> or <>/><.
5. Select the disc that contains the track to be added by rotating the MULTI JOG knob (pressing +/- on the remote control).
6. Press the MULTI JOG knob (ENTER on the remote control) to confirm the disc that contains the track to be added.

Press **CLEAR** to cancel the confirmed selection.

Continues to next page

7. Select the track to be added by rotating the MULTI JOG knob (pressing +/- on the remote control).
8. Press the MULTI JOG knob (ENTER on the remote control) to confirm the track to be added.

When continuing to add tracks to the album, repeat steps 4—8.

9. Press COMPLETE.

The selected tracks are added to the album.

This unit returns to the editing menu item selection.

■ When deleting tracks from the album

4. Select the track to be deleted by pressing <<</>>> or <>/><.

5. Press CLEAR.

Note

- The tracks following the deleted track will automatically be down-numbered.

When continuing to delete tracks from the album, repeat steps 4 and 5.

6. Press COMPLETE.

The selected tracks are deleted from the album.

This unit returns to the editing menu item selection.

Album Copy

You can copy the entire disc, album, or bookmark to a new album.

1. Select and confirm “Album Copy” in step 4 of “Editing during the stop mode” on page 30.

The following message appears on the display.

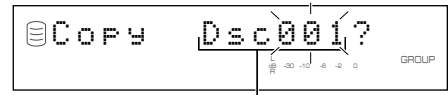

Group to be copied from

The number of the group to be copied from flashes.

2. Select the group to be copied from by rotating the MULTI JOG knob (pressing +/- on the remote control).

The group to be copied from switches in the order of “disc” → “album” → “bookmark”.

3. Press the MULTI JOG knob (ENTER on the remote control) to confirm the group to be copied from.

The display scrolls to the left to indicate the number of the group to be copied from and the number of the album to be copied to. The album to be copied on is assigned the smallest available number.

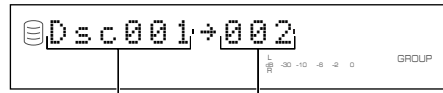

Group to be copied from Album to be copied to

Press CLEAR to cancel the confirmed selection.

4. Press COMPLETE.

The selected group is copied to a new album.

This unit returns to the editing menu item selection.

Album Rename

You can move the album and assign a new number.

1. Select and confirm “Album Rename” in step 4 of “Editing during the stop mode” on page 30.

The following message appears on the display.



Album to be moved

The number of the album to be moved flashes.

2. Select the album to be moved by rotating the MULTI JOG knob (pressing +/- on the remote control).

3. Press the MULTI JOG knob (ENTER on the remote control) to confirm the album to be moved.

The display scrolls to the left to indicate the number of the album to be moved and the new album number.

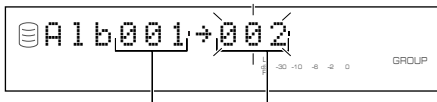

Album to be moved New album number

Press **CLEAR** to cancel the confirmed selection.

4. Select the new album number by rotating the MULTI JOG knob (pressing +/- on the remote control).

5. Press the MULTI JOG knob (ENTER on the remote control) to confirm the new album number.

Press **CLEAR** to cancel the confirmed selection.

6. Press **COMPLETE**.

The selected album has been moved and assigned a new number.

This unit returns to the editing menu item selection.

Notes

- If the selected new album number is already in use, the albums following this renumbered album will be automatically up-numbered by one. However, if there is any unused album number, only the albums up to that number will be up-numbered.
- The original number of the album that has been renumbered will be available for future use.

Album Delete

You can delete an existing album.

■ Editing during the stop mode

1. Select and confirm “Album Delete” in step 4 of “Editing during the stop mode” on page 30.

The following message appears on the display.



Album to be deleted

The number of the album to be deleted flashes.

2. Select the album to be deleted by rotating the MULTI JOG knob (pressing +/- on the remote control).

3. Press the MULTI JOG knob (ENTER on the remote control) to confirm the album to be deleted.

Press **CLEAR** to cancel the confirmed selection.

4. Press **COMPLETE**.

The selected album has been deleted.

This unit returns to the editing menu item selection.

■ Editing during playback

1. Select and confirm “Album Delete” in step 2 of “Editing during playback” on page 30.

The album being played is confirmed to be deleted.

2. Press **COMPLETE**.

The album being played will be deleted.

Playback resumes from the beginning of the next album after the deleted album. If no album follows the deleted album, this unit plays the previous album of the deleted album.

Note

- The number of the deleted album will be available for future use.

Album Pack

You can re-organize the album numbers by eliminating unused album numbers that have been created by changing album numbers or deleting albums.

1. Select and confirm “Album Pack” in step 4 of “Editing during the stop mode” on page 30.

The following message appears on the display.

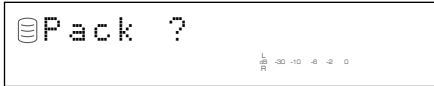

2. Press COMPLETE.

The album numbers are re-organized without unused album numbers.

This unit returns to the editing menu item selection.

Before “Album Pack” is performed

| | | | | | |
|---|--|---|---|--|---|
| 1 | | 3 | 4 | | 6 |
|---|--|---|---|--|---|

| | | | | | |
|---|---|---|---|---|---|
| 1 | 2 | 3 | 4 | 5 | 6 |
|---|---|---|---|---|---|

After “Album Pack” has been performed (Unused album numbers have been eliminated.)

■ : Unused album numbers

Album Title

You can assign a title to a created album.

■ Editing during the stop mode

1. Select and confirm “Album Title” in step 4 of “Editing during the stop mode” on page 30.

The following message appears on the display.



Album to assign the title to

The number of the album to assign a title to flashes.

2. Select the album to assign a title to by rotating the MULTI JOG knob (pressing +/- on the remote control).

3. Press the MULTI JOG knob (ENTER on the remote control) to confirm the album to assign a title to. The following message appears on the display.



The cursor flashes.

If the selected album already has a title, the title appears on the display.

4. Enter the title characters by using the MULTI JOG knob or the alphabetical/numeric buttons on the remote control.

See next page for entering procedure.

5. Press COMPLETE when all the characters have been entered.

The title is assigned to the selected album.

This unit returns to the editing menu item selection.

■ Editing during playback

1. Select and confirm “Album Title” in step 2 of “Editing during playback” on page 30.

The album being played is confirmed for assigning the title to.

The following message appears on the display.



The cursor flashes.

If the selected album already has a title, the title appears on the display.

2. Enter the title characters by using the MULTI JOG knob or the alphabetical/numeric buttons on the remote control.

See next page for entering procedure.

3. Press COMPLETE when all the characters have been entered.

The title is assigned to the selected album.

Playback resumes from the beginning of the album with the title assigned to.

Continues to next page

■ Entering the title characters by using the MULTI JOG knob

1. Rotate the MULTI JOG knob clockwise.

When the **MULTI JOG** knob is rotated clockwise, characters appear in the order of alphabetical capital letters, alphabetical lower case letters, numbers, and symbols. Select the character you wish to use for the title.

2. Press the MULTI JOG knob to confirm the selected character.

The cursor moves to the next space. Repeat steps 1 and 2 until the title is complete. A title can contain up to 32 characters.

■ Entering the title characters by using the alphabetical/numeric buttons on the remote control

1. Select the character to be used for the title by using the alphabetical/numeric buttons on the remote control.

Alphabetical capital letters, alphabetical lower case letters, and numbers switch each time the buttons are pressed. To create a space, press **SPACE**. To use a symbol, press **SYMBOL** to select the desired symbol.

2. Select the next character by pressing one of the alphabetical/numeric buttons.

The cursor automatically moves to the next space. When the same button is used, press **▶▶** to move the cursor to the next space.

Note

- If a new character is entered on the existing character, the new character is inserted in front of the existing character.

■ Correcting the characters

Move the cursor to the character to be corrected by pressing **◀◀** or **▶▶/▶▶** (**◀◀** or **▶▶** on the remote control). Press **CLEAR** to cancel the character before a new character is entered. Then enter and confirm the new character.

Track Shuffle

You can change the order of tracks in an album.

■ Editing during the stop mode

1. Select and confirm "Track Shuffle" in step 4 of "Editing during the stop mode" on page 30.

The following message appears on the display.

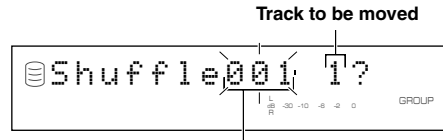

Album to change its tracks' order

The number of the album to change its tracks' order flashes.

2. Rotate the MULTI JOG knob (press +/- on the remote control) to select the album to change its tracks' order.

3. Press the MULTI JOG knob (ENTER on the remote control) to confirm the album to change its tracks' order.

The number of the track to be moved flashes.

Press **CLEAR** to cancel the confirmed selection.

4. Rotate the MULTI JOG knob (+/- on the remote control) to select the track to be moved.

5. Press the MULTI JOG knob (ENTER on the remote control) to confirm the track to be moved.

The display scrolls to the left to indicate the number of the album to change its tracks' order, the number of the track to be moved, and the new track number.

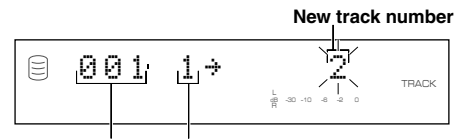

Album to change its tracks' order Track to be moved

Press **CLEAR** to cancel the confirmed selection.

Continues to next page

6. Rotate the MULTI JOG knob (press +/- on the remote control) to select the new track number.
7. Press the MULTI JOG knob (ENTER on the remote control) to confirm the new track number.
Press CLEAR to cancel the confirmed selection.
8. Press COMPLETE.
The selected track has been moved and assigned a new number.
This unit returns to the editing menu item selection.

■ Editing during playback

1. Select and confirm “Track Shuffle” in step 2 of “Editing during playback” on page 30.
The track being played is confirmed to be moved.
The number of the album and track being played and the new track number appear on the display.

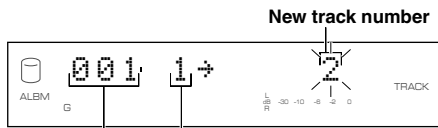

2. Rotate the MULTI JOG knob (press +/- on the remote control) to select the new track number.
3. Press the MULTI JOG knob (ENTER on the remote control) to confirm the new track number.
Press CLEAR to cancel the confirmed selection.
4. Press COMPLETE.
The track being played has been moved and assigned a new number.
Playback resumes from the beginning of the moved track.

Track Level

You can adjust the sound level of track in an album.

■ Editing during the stop mode

1. Select and confirm “Track Level” in step 4 of “Editing during the stop mode” on page 30.
The following message appears on the display.

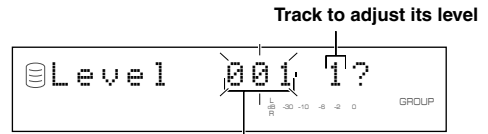

The number of the album to adjust its tracks' level flashes.

2. Rotate the MULTI JOG knob (press +/- on the remote control) to select the album to adjust its tracks' level.
3. Press the MULTI JOG knob (ENTER on the remote control) to confirm the album to adjust its tracks' level.
The number of the track to adjust its level flashes.
Press CLEAR to cancel the confirmed selection.

4. Rotate the MULTI JOG knob (+/- on the remote control) to select the track to adjust.
5. Press the MULTI JOG knob (ENTER on the remote control) to confirm the track to adjust its level.
Playback of the confirmed track starts, and the following message appears on the display.



Press CLEAR to cancel the confirmed selection.

Continues to next page

6. Rotate the MULTI JOG knob (press +/- on the remote control) to adjust the level.

Adjustment is possible in the -12dB to +12dB range by 0.4dB steps.

You can compare the level with the previous or next tracks' level by pressing <<</>>> or >>>/<<< (<<< or >>> on the remote control).

You can also search the passage in the selected track by pressing and holding <<</>>> or >>>/<<< (<<< or >>> on the remote control).

7. Press COMPLETE.

The level of the selected track is confirmed.

This unit returns to the editing menu item selection.

■ Editing during playback

1. Select and confirm "Track Level" in step 2 of "Editing during playback" on page 30.

The track being played is confirmed to adjust its level.

The following message appears on the display.



Track being played

2. Rotate the MULTI JOG knob (press +/- on the remote control) to adjust the level.

Adjustment is possible in the -12dB to +12dB range by 0.4dB steps.

You can compare the level with the previous or next tracks' level by pressing <<</>>> or >>>/<<< (<<< or >>> on the remote control).

You can also search the passage in the selected track by pressing and holding <<</>>> or >>>/<<< (<<< or >>> on the remote control).

3. Press COMPLETE.

The level of the track being played is confirmed.

Playback resumes from the beginning of the track with its level adjusted.

Notes

- The level may change slightly out of the point that the track itself changes during the playback of the album with its tracks' level adjusted. In this case, add the 1-to-2 second interval using the "Tr. Interval" function described on the next page.
- You can not copy the album with its tracks' level adjusted in the Audio Master Quality Recording mode (see page 63).
- You can also adjust the copy level (see page 66) when copying the album with its tracks' level adjusted. The copy will be made in the total level adjusted in "Track Level" and "Copy Level" on the copy menu.

Tr. Interval

You can adjust each track interval in an album.

■ Editing during the stop mode

1. Select and confirm “Tr. Interval” in step 4 of “Editing during the stop mode” on page 30.

The following message appears on the display.

Track to adjust its interval between the previous track

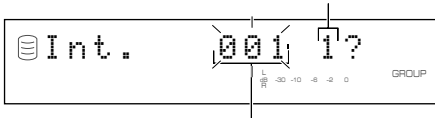

Album to adjust its track interval

The number of the album to adjust its tracks' interval flashes.

2. Rotate the MULTI JOG knob (press +/- on the remote control) to select the album to adjust its tracks interval.

3. Press the MULTI JOG knob (ENTER on the remote control) to confirm the album to adjust its tracks interval.

The number of the track to be adjusted flashes.

Press CLEAR to cancel the confirmed selection.

4. Rotate the MULTI JOG knob (+/- on the remote control) to select the track to adjust its interval between the previous track.

5. Press the MULTI JOG knob (ENTER on the remote control) to confirm the track to adjust its interval between the previous track.

The ending of the previous track for 5 seconds and the beginning of the confirmed track for 5 seconds will be repeatedly played.

The following message appears on the display.

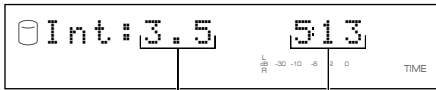

Track interval Playing time of the track

Press CLEAR to cancel the confirmed selection.

Note

- If there is no track before the track that is selected and confirmed, “No Previous” appears on the display, and this unit returns to step 4.

6. Rotate the MULTI JOG knob (press +/- on the remote control) to adjust the interval.

Adjustment is possible in the 0 to 9.9 seconds range by 0.1-second steps.

If you stop rotating the MULTI JOG knob, the ending of the previous track for 5 seconds and the beginning of the confirmed track for 5 seconds will be repeatedly played with the adjusted interval.

7. Press COMPLETE.

The interval between the selected track and the previous track is confirmed.

This unit returns to the editing menu item selection.

■ Editing during playback

1. Select and confirm “Tr. Interval” in step 2 of “Editing during playback” on page 30.

The track being played is confirmed to adjust its interval.

The ending of the previous track for 5 seconds and the beginning of the confirmed track for 5 seconds will be repeatedly played.

The following message appears on the display.

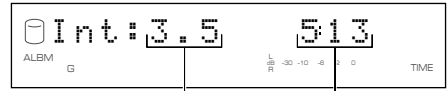

Track interval Playing time of the track

2. Rotate the MULTI JOG knob (press +/- on the remote control) to adjust the interval.

Adjustment is possible in the 0 to 9.9 seconds range by 0.1-second steps.

If you stop rotating the MULTI JOG knob, the ending of the previous track for 5 seconds and the beginning of the confirmed track for 5 seconds will be repeatedly played with the adjusted interval.

3. Press COMPLETE.

The interval between the selected track and the previous track is confirmed.

Playback resumes from the beginning of the track with its interval between the previous track adjusted.

TRACK EDITING

You can do various editing operations on the tracks that have been recorded on the HDD.

Track Editing Operation

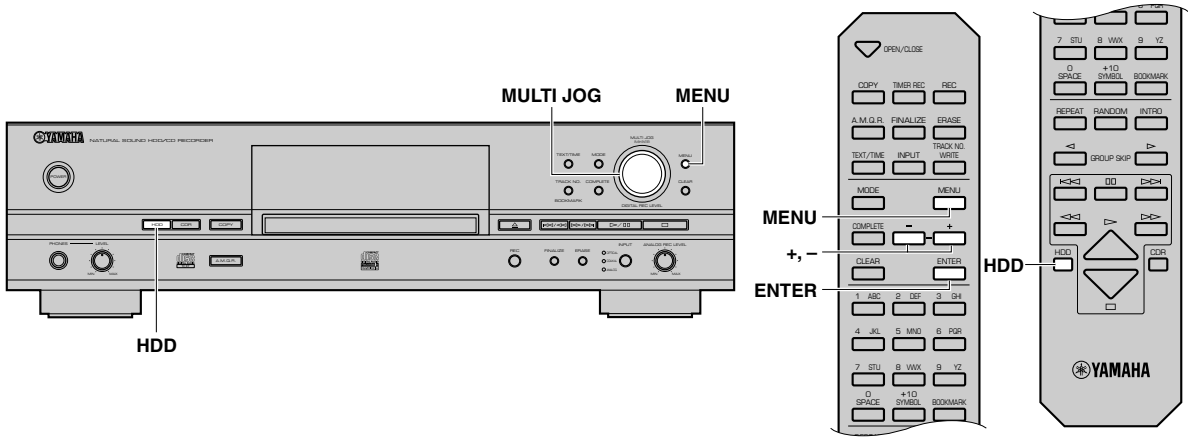

■ Editing during the stop mode

1. Press **HDD** to select the HDD.
2. Press **MENU**.
The display changes for the menu item selection.
3. Select "Track Edit" by rotating the **MULTI JOG knob** (pressing +/- on the remote control).



4. Press **MULTI JOG knob (ENTER on the remote control)**.
The display changes for the editing menu item selection.
5. Select the menu item by rotating the **MULTI JOG knob (pressing +/- on the remote control)**.
The followings are the track editing menu items:

- Track Rename
- Track Adjust
- Track Erase
- Part Erase
- Track Combine
- Track Divide
- Track Pack
- Add Fade In
- Add Fade Out
- Track Title

6. Press **MULTI JOG knob (ENTER on the remote control)**.
The selected item is confirmed. Then editing operation can be started.
7. Start editing by following the setting details (pages 40—51) for each menu item.
8. Press **□** when all editing has been completed.
This unit returns to the stop mode.

■ Editing during playback

Press **MULTI JOG knob** to light up the **TRACK** indicator.

1. Press **MENU** while the track (in the disc) to be edited is being played.
The display changes for the editing menu item selection.
2. Select the menu item by rotating the **MULTI JOG knob (pressing +/- on the remote control)**.
The followings are the track editing menu items:

- Track Rename
- Track Adjust
- Track Erase
- Part Erase
- Track Combine
- Track Divide
- Add Fade In
- Add Fade Out
- Track Title

3. Press **MULTI JOG knob (ENTER on the remote control)**.
The selected item is confirmed. Then editing operation can be started.
4. Start editing by following the setting details (pages 40—51) for each menu item.

Notes

- If **MENU** is pressed during editing, entry of the selection is canceled, and then this unit returns to the following state;
 - This unit returns to the editing menu item selection if having started editing during the stop mode.
 - This unit returns to the playback if having started editing during playback.
- If **□** is pressed during editing, all entry of the selection is canceled, and this unit returns to the stop mode.

Track Rename

You can move a track and assign a new number.

■ Editing during the stop mode

1. Select and confirm "Track Rename" in step 5 of "Editing during the stop mode" on page 39.

The following message appears on the display.

Disc that contains the track to be moved

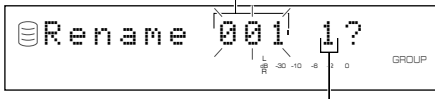

Track to be moved

The disc number that contains the track to be moved flashes.

2. Select the disc that contains the track to be moved by rotating the MULTI JOG knob (pressing +/- on the remote control).

3. Press the MULTI JOG knob (ENTER on the remote control) to confirm the disc that contains the track to be moved.

The number of the track to be moved flashes.

Press CLEAR to cancel the confirmed selection.

4. Select the track to be moved by rotating the MULTI JOG knob (pressing +/- on the remote control).

5. Press the MULTI JOG knob (ENTER on the remote control) to confirm the track to be moved.

The display scrolls to the left to indicate the disc number that contains the track to be moved, the existing track number, and the new track number.

Disc that contains the track to be moved

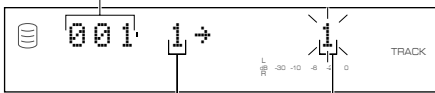

Existing track number

New track number

Press CLEAR to cancel the confirmed selection.

6. Select the new track number by rotating the MULTI JOG knob (pressing +/- on the remote control).

7. Press the MULTI JOG knob (ENTER on the remote control) to confirm the new track number.

Press CLEAR to cancel the confirmed selection.

8. Press COMPLETE.

The selected track is renumbered.

This unit returns to the editing menu item selection.

■ Editing during playback

1. Select and confirm "Track Rename" in step 2 of "Editing during playback" on page 39.

The track being played is confirmed to be moved and assigned a new number.

The number of the disc and track being played and the new track number appear on the display.

Disc being played

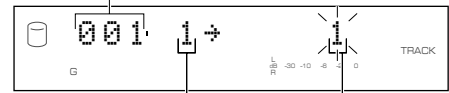

Track being played

New track number

2. Select the new track number by rotating the MULTI JOG knob (pressing +/- on the remote control).

3. Press the MULTI JOG knob (ENTER on the remote control) to confirm the new track number.

Press CLEAR to cancel the confirmed selection.

4. Press COMPLETE.

The track being played is moved and assigned a new number.

Playback resumes from the beginning of the renumbered track.

Notes

- If the selected new track number is already in use, the tracks following this renumbered track will be automatically up-numbered by one. However, if there is any unused track number, only the tracks up to that number will be up-numbered.
- The original number of the track that has been renumbered will be available for future use.

Track Adjust

You can change the beginning of the track to either earlier or later.

■ Editing during the stop mode

1. Select and confirm "Track Adjust" in step 5 of "Editing during the stop mode" on page 39.

The following message appears on the display.

Disc that contains the track to be adjusted

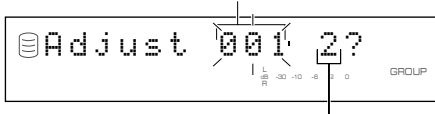

Track to be adjusted

The disc number that contains the track to be adjusted flashes.

2. Select the disc that contains the track to be adjusted by rotating the MULTI JOG knob (pressing +/- on the remote control).
3. Press the MULTI JOG knob (ENTER on the remote control) to confirm the disc that contains the track to be adjusted.

The number of the track to be adjusted flashes.

Press **CLEAR** to cancel the confirmed selection.

4. Select the track to be adjusted by rotating the MULTI JOG knob (pressing +/- on the remote control).
5. Press the MULTI JOG knob (ENTER on the remote control) to confirm the track to be adjusted.

The confirmed track will be played.

The following message appears in the display.

The time length to be adjusted

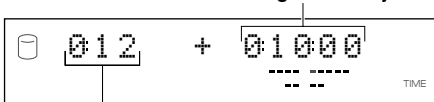

Playing time of the track

Note

- If there is no track before the track that is selected and confirmed, "No Previous" appears on the display, and this unit returns to step 4.

6. Adjust the time length to change the beginning of the track by rotating the MULTI JOG knob (pressing +/- on the remote control).

The time length can be adjusted by "minute: second: frame". (Frame is the unit used for values smaller than 1 second. 75 frames make 1 second.) The unit to be set is flashing. Move the flash to the unit to be adjusted by pressing <<</>>> or >>>/<<<.

If you stop rotating the **MULTI JOG** knob, this unit searches for the temporarily changed beginning point of the track according to the time length setting made, and starts repeated playback from the new beginning point to the end of the disc.

Press **CLEAR** to cancel the adjustment.

7. Press **COMPLETE**.

The new track beginning point is set.

This unit returns to the editing menu item selection.

■ Editing during playback

1. Select and confirm "Track Adjust" in step 2 of "Editing during playback" on page 39.

The track being played is confirmed to be adjusted.

The following message appears on the display.

The time length to be adjusted

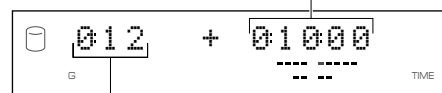

Playing time of the track

Note

- If there is no track before the track that is selected and confirmed, "No Previous" appears on the display, and this unit returns to the playback.

2. Adjust the time length to change the beginning of the track by rotating the MULTI JOG knob (pressing +/- on the remote control).

The time length can be adjusted by "minute: second: frame". The unit to be set is flashing. Move the flash to the unit to be adjusted by pressing <<</>>> or >>>/<<<.

If you stop rotating the **MULTI JOG** knob, this unit searches for the temporarily changed beginning point of the track according to the time length setting made, and starts repeated playback from the new beginning point to the end of the disc.

Press **CLEAR** to cancel the adjustment.

Continues to next page

3. Press COMPLETE.

The new track beginning point is set. Playback resumes from the beginning of the adjusted track.

Before "Track Adjust" is performed

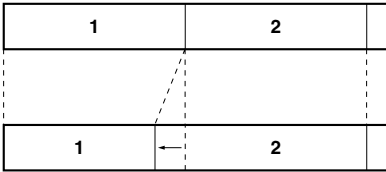

After "Track Adjust" has been performed (The beginning of track 2 is adjusted earlier.)

Notes

- If the adjusted track includes a part that cannot be copied digitally before adjusting, the adjusted track itself cannot be copied digitally either.
- When the emphasis status of the track to be adjusted is different from that of the previous track, the emphasis status of the track to be adjusted takes precedence over that of the previous track.

Track Erase

You can erase a selected track.

■ Editing during the stop mode

1. Select and confirm "Track Erase" in step 5 of "Editing during the stop mode" on page 39.

The following message appears on the display.

Disc that contains the track to be erased

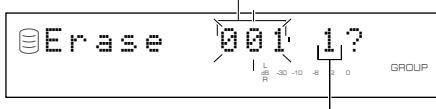

Track to be erased

The disc number that contains the track to be erased flashes.

2. Select the disc that contains the track to be erased by rotating the MULTI JOG knob (pressing +/- on the remote control).

3. Press the MULTI JOG knob (ENTER on the remote control) to confirm the disc that contains the track to be erased.

The number of the track to be erased flashes.

Press **CLEAR** to cancel the confirmed selection.

4. Select the track to be erased by rotating the MULTI JOG knob (pressing +/- on the remote control).

5. Press the MULTI JOG knob (ENTER on the remote control) to confirm the track to be erased.

Press **CLEAR** to cancel the confirmed selection.

To check the track to be erased, press \triangleright/\square (\triangleright on the remote control). This unit starts to play the track to be erased repeatedly.

6. Press COMPLETE.

The selected track is erased.

This unit returns to the editing menu item selection.

■ Editing during playback

1. Select and confirm "Track Erase" in step 2 of "Editing during playback" on page 39.

The track being played is confirmed to be erased.

2. Press COMPLETE.

The track being played is erased.

Playback resumes from the beginning of the next track after the erased track. If no track follows the erased track, this unit plays the previous track of the erased track.

Note

- The number of the track that has been erased will be available for future use.

Part Erase

You can erase part of a selected track.

■ Editing during the stop mode

1. Select and confirm “Part Erase” in step 5 of the “Editing during the stop mode” on page 39.

The following message appears on the display.

Disc that contains the track to be partially erased

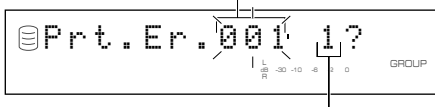

Track to be partially erased

The disc number that contains the track to be partially erased flashes.

2. Select the disc that contains the track to be partially erased by rotating the MULTI JOG knob (pressing +/- on the remote control).

3. Press the MULTI JOG knob (ENTER on the remote control) to confirm the disc that contains the track to be partially erased.

The number of the track to be partially erased flashes.

Press **CLEAR** to cancel the confirmed selection.

4. Select the track to be partially erased by rotating the MULTI JOG knob (pressing +/- on the remote control).

5. Press the MULTI JOG knob (ENTER on the remote control) to confirm the track to be partially erased.

The passage between the point that is 5 seconds before the temporary beginning point of the partial erase and the temporary beginning point (the point that is 10 seconds elapsed from the beginning of the track) is repeatedly played.

The following message appears on the display.

Beginning point of the partial erase



Playing time of the track

6. Set the beginning point of the partial erase by rotating the MULTI JOG knob (pressing +/- on the remote control).

The beginning point of the partial erase can be set by “minute: second: frame”. The unit to be set is flashing. Move the flash to the unit to be set by pressing <<</><< or >>/>>>.

If you stop rotating the **MULTI JOG** knob, this unit searches for the beginning point according to the setting made, and starts repeated playback of the passage between the point that is 5 seconds before the beginning point and the beginning point.

7. Press MULTI JOG knob (ENTER on the remote control) to confirm the beginning point of the partial erase.

The passage between the temporary ending point of the partial erase (the point that is 10 seconds after the beginning point) and the point that is 5 seconds after the temporary ending point is repeatedly played.

The following message appears on the display.

Ending point of the partial erase



Playing time of the track

Press **CLEAR** to cancel the confirmed selection.

8. Set the ending point of the partial erase by rotating the MULTI JOG knob (pressing +/- on the remote control).

The ending point of the partial erase can be set by “minute: second: frame”. The unit to be set is flashing. Move the flash to the unit to be set by pressing <<</><< or >>/>>>.

If you stop rotating the **MULTI JOG** knob, this unit searches for the ending point according to the setting made, and starts repeated playback of the passage between the ending point and the point that is 5 seconds after the ending point.

9. Press MULTI JOG knob (ENTER on the remote control) to confirm the ending point of the partial erase.

The passage between the point that is 5 seconds before the beginning point and the point that is 5 seconds after the ending point of the partial erase is repeatedly played.

The following message appears on the display.

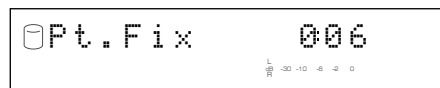
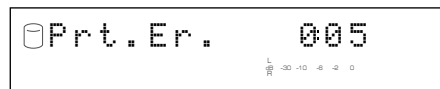

Caution

- During the playback of the passage mentioned above, the sound may missing at the joint between the passage before the beginning point and the passage after the ending point. However, the partially erased track is played properly after the partial erase has been completed.

To change the ending point, press **CLEAR** once to return to step 8.

To change the beginning point, press **CLEAR** twice to return to step 6.

10. Press COMPLETE.

The selected part is erased.

This unit returns to the editing menu item selection.

Continues to next page

■ Editing during playback

1. Select and confirm “Part Erase” in step 2 of “Editing during playback” on page 39.

The track being played is confirmed to be partially erased. The passage between the point that is 5 seconds before the beginning point of the partial erase and the beginning point (the timing you press **MENU**) is repeatedly played. The following message appears on the display.

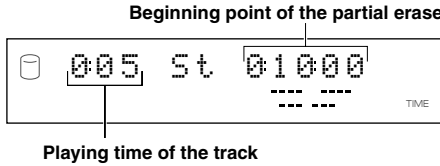

2. Set the beginning point of the partial erase by rotating the MULTI JOG knob (pressing +/- on the remote control).

The beginning point of the partial erase can be set by “minute: second: frame”. The unit to be set is flashing. Move the flash to the unit to be set by pressing <<</><< or >>/>>>.

If you stop rotating the **MULTI JOG** knob, this unit searches for the beginning point according to the setting made, and starts repeated playback of the passage between the point that is 5 seconds before the beginning point and the beginning point.

3. Press MULTI JOG knob (ENTER on the remote control) to confirm the beginning point of the partial erase.

The passage between the temporary ending point of the partial erase (the point that is 10 seconds after the beginning point) and the point that is 5 seconds after the temporary ending point is repeatedly played. The following message appears on the display.

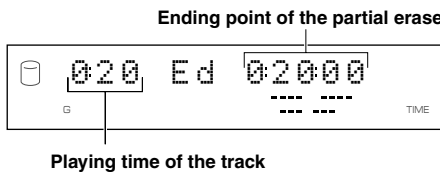

Press **CLEAR** to cancel the confirmed selection.

4. Set the ending point of the partial erase by rotating the MULTI JOG knob (pressing +/- on the remote control).

The ending point of the partial erase can be set by “minute: second: frame”. The unit to be set is flashing. Move the flash to the unit to be set by pressing <<</><< or >>/>>>.

If you stop rotating the **MULTI JOG** knob, this unit searches for the ending point according to the setting made, and starts repeated playback of the passage between the ending point and the point that is 5 seconds after the ending point.

5. Press MULTI JOG knob (ENTER on the remote control) to confirm the ending point of the partial erase.

The passage between the point that is 5 seconds before the beginning point and the point that is 5 seconds after the ending point of the partial erase is repeatedly played. The following message appears on the display.

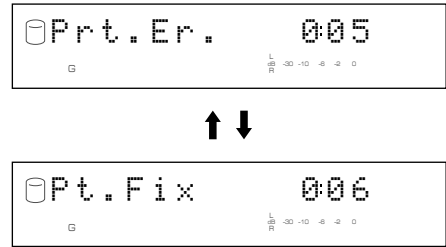

Caution

- During the playback of the passage mentioned above, the sound may missing at the joint between the passage before the beginning point and the passage after the ending point. However, the partially erased track is played properly after the partial erase has been completed.

To change the ending point, press **CLEAR** once to return to step 4.

To change the beginning point, press **CLEAR** twice to return to step 2.

6. Press COMPLETE.

The selected part is erased.

Playback resumes from the beginning of the partially erased track.

Caution

- The minimum length of a track is 4 seconds. It is not possible to create a track that is shorter than 4 seconds by a partial erase.

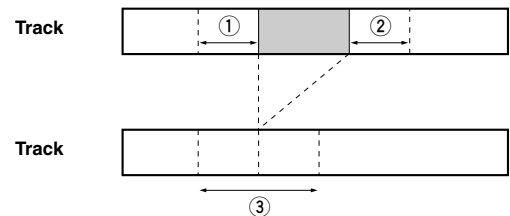

■ : Part to be erased

- ① Repeated passage when setting the beginning point
- ② Repeated passage when setting the ending point
- ③ Repeated passage after confirming the ending point

Track Combine

You can combine a series of tracks into one.

■ Editing during the stop mode

1. Select and confirm “Track Combine” in step 5 of “Editing during the stop mode” on page 39.

The following message appears on the display.

Disc that contains the first track to be combined

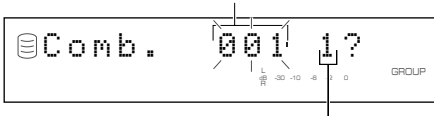

Track to be the first in the combination

The disc number that contains the first track to be combined flashes.

2. Select the disc that contains the first track to be combined by rotating the MULTI JOG knob (pressing +/- on the remote control).

3. Press the MULTI JOG knob (ENTER on the remote control) to confirm the disc that contains the first track to be combined.

The number of the track to be the first in the combination flashes.

Press **CLEAR** to cancel the confirmed selection.

4. Select the track to be the first in the combination by rotating the MULTI JOG knob (pressing +/- on the remote control).

5. Press the MULTI JOG knob (ENTER on the remote control) to confirm the track to be the first in the combination.

The display scrolls to the left to indicate the disc number that contains the first track to be combined, the track number to be the first in the combination, and the track number to be the last in the combination.

Disc that contains the first track in the combination

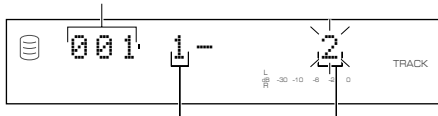

Track to be the first in the combination

Track to be the last in the combination

Press **CLEAR** to cancel the confirmed selection.

6. Select the track to be the last in the combination by rotating the MULTI JOG knob (pressing +/- on the remote control).

7. Press the MULTI JOG knob (ENTER on the remote control) to confirm the track to be the last in the combination.

Press **CLEAR** to cancel the confirmed selection.

8. Press **COMPLETE**.

The two selected tracks and all those between are combined into one track.

This unit returns to the editing menu item selection.

■ Editing during playback

1. Select and confirm “Track Combine” in step 2 of “Editing during playback” on page 39.

The track being played is confirmed to be the first track in the combination.

The number of the disc and track being played and the number of the track to be the last in the combination appear on the display.

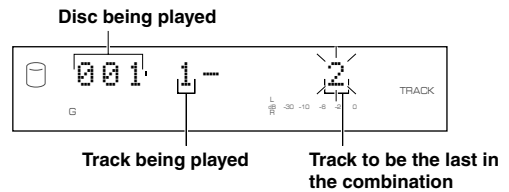

2. Select the track to be the last in the combination by rotating the MULTI JOG knob (pressing +/- on the remote control).

3. Press the MULTI JOG knob (ENTER on the remote control) to confirm the track to be the last in the combination.

Press **CLEAR** to cancel the confirmed selection.

4. Press **COMPLETE**.

The two selected tracks and all those between are combined into one track.

Playback resumes from the beginning of the combined track.

Notes

- When combining a series of tracks, the selected track numbers following the selected first track will be available for future use.
- The track title for the first track is effective for the combined track.
- If there is any track that cannot be copied digitally among the tracks to be combined, the combined track cannot be copied digitally either.
- When tracks with different emphasis status have been combined, the emphasis status of the first track becomes effective for the combined track.

Track Divide

You can divide a track into two at the selected point.

■ Editing during the stop mode

1. Select and confirm "Track Divide" in step 5 of "Editing during the stop mode" on page 39.

The following message appears on the display.

Disc that contains the track to be divided

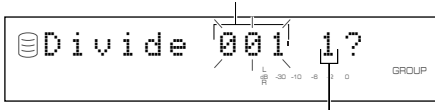

Track to be divided

The disc number that contains the track to be divided flashes.

2. Select the disc that contains the track to be divided by rotating the MULTI JOG knob (pressing +/- on the remote control).

3. Press the MULTI JOG knob (ENTER on the remote control) to confirm the disc that contains the track to be divided.

The number of the track to be divided flashes.

Press CLEAR to cancel the confirmed selection.

4. Select the track to be divided by rotating the MULTI JOG knob (pressing +/- on the remote control).

5. Press the MULTI JOG knob (ENTER on the remote control) to confirm the track to be divided.

The passage between the temporary dividing point (the point that is 10 seconds elapsed from the beginning of the track) and the point that is 5 seconds after the temporary dividing point is repeatedly played.

The following message appears on the display.

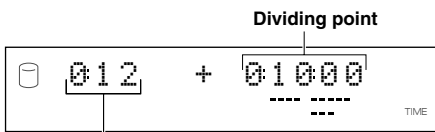

Playing time of the track

6. Set the dividing point by rotating the MULTI JOG knob (pressing +/- on the remote control).

The dividing point can be set by "minute: second: frame". The unit to be set is flashing. Move the flash to the unit to be set by pressing <<</><< or >>/>>.

If you stop rotating the MULTI JOG knob, this unit searches for the dividing point according to the setting made, and starts repeated playback of the passage between the dividing point and the point that is 5 seconds after the dividing point.

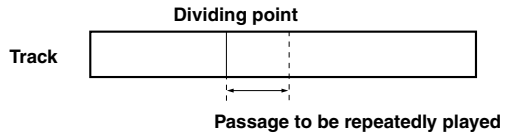

7. Press COMPLETE.

The selected track is divided into two at the set dividing point. This unit returns to the editing menu item selection.

■ Editing during playback

1. Select and confirm "Track Divide" in step 2 of "Editing during playback" on page 39.

The track being played is confirmed to be divided.

The passage between the dividing point (the timing you press MENU) and the point that is 5 seconds after the dividing point is repeatedly played.

The following message appears on the display.

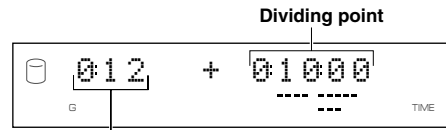

Playing time of the track

2. Set the dividing point by rotating the MULTI JOG knob (pressing +/- on the remote control).

The dividing point can be set by "minute: second: frame". The unit to be set is flashing. Move the flash to the unit to be set by pressing <<</><< or >>/>>.

If you stop rotating the MULTI JOG knob, this unit searches for the dividing point according to the setting made, and starts repeated playback of the passage between the dividing point and the point that is 5 seconds after the dividing point.

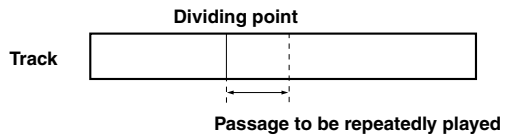

Continues to next page

3. Press COMPLETE.

The track being played is divided into two at the set dividing point.

Playback resumes from the beginning of the second track of the two divided tracks.

Cautions

- The minimum length of a track is 4 seconds. It is not possible to create a track that is shorter than 4 seconds by dividing a track.
- One disc can contain up to 99 tracks. If the disc already contains 99 tracks, "Track No.Full" appears on the display.

Note

- The track numbers following the divided track will be up-numbered by one. However, if there is any unused track number, only the tracks up to that number will be up-numbered.

Before "Track Divide" is performed

| | | | | | |
|------------------|---|---|---|---|---|
| 1 | 2 | | 4 | 5 | 6 |
| Divided into two | | | | | |
| 1 | 2 | 3 | 4 | 5 | 6 |

After "Track Divide" has been performed (dividing a track into two)

■ : Space not being used

Track Pack

You can re-organize the track numbers by eliminating unused track numbers, that have been created by changing track numbers or erasing tracks.

1. Select and confirm "Track Pack" in step 5 of "Editing during the stop mode" on page 39.

The following message appears on the display.

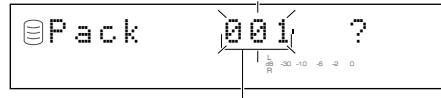

Disc on which unused track numbers are to be eliminated

2. Select the disc on which unused track numbers are to be eliminated by rotating the MULTI JOG knob (pressing +/- on the remote control).**3. Press the MULTI JOG knob (ENTER on the remote control) to confirm the disc on which unused track numbers are to be eliminated.**

Press CLEAR to cancel the confirmed selection.

4. Press COMPLETE.

The track numbers are re-organized by eliminating unused track numbers.

This unit returns to the editing menu item selection.

Before "Track Pack" is performed

| | | | | | |
|---|---|---|---|---|---|
| 1 | | 3 | 4 | | 6 |
| 1 | 2 | 3 | 4 | 5 | 6 |

After "Track Pack" has been performed (Unused track numbers have been eliminated.)

■ : Unused track numbers

Add Fade In

You can add fade-in at the beginning of a track. The beginning of the track is played with gradually rising level when fade-in has been added.

■ Editing during the stop mode

1. Select and confirm “Add Fade In” in step 5 of “Editing during the stop mode” on page 39.

The following message appears on the display.

Disc that contains the track to add fade-in

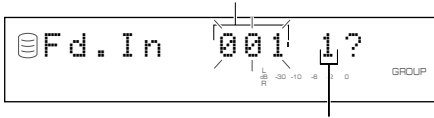

Track to add fade-in

The disc number that contains the track to add fade-in flashes.

2. Select the disc that contains the track to add fade-in by rotating the MULTI JOG knob (pressing +/- on the remote control).
3. Press the MULTI JOG knob (ENTER on the remote control) to confirm the disc that contains the track to add fade-in.
4. Select the track to add fade-in by rotating the MULTI JOG knob (pressing +/- on the remote control).
5. Press the MULTI JOG knob (ENTER on the remote control) to confirm the track to add fade-in.

The beginning of the track for 8 seconds is repeatedly played with a 3-second (initial setting) fade-in.

The following message appears on the display.

Fade-in length

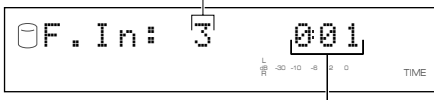

Playing time of the track

6. Rotate MULTI JOG knob (+/- on the remote control) to set the fade-in length.

The fade-in length can be set in the 1 to 10 second range by 1-second steps.

If you stop rotating the MULTI JOG knob, this unit starts repeated playback of the beginning of the track with a fade-in of the length set in above step, with extra portion for further 5 seconds.

Press CLEAR to cancel the setting.

7. Press COMPLETE.

The fade-in is added to the beginning of the selected track for the selected length.

This unit returns to the editing menu item selection.

■ Editing during playback

1. Select and confirm “Add Fade In” in step 2 of “Editing during playback” on page 39.

The track being played is confirmed to add fade-in to.

The beginning of the track for 8 seconds is repeatedly played with a 3-second (initial setting) fade-in.

The following message appears on the display.

Fade-in length

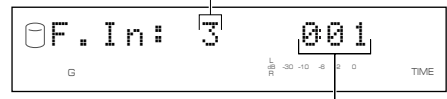

Playing time of the track

2. Rotate MULTI JOG knob (+/- on the remote control) to set the fade-in length.

The fade-in length can be set in the 1 to 10 second range by 1-second steps.

If you stop rotating the MULTI JOG knob, this unit starts repeated playback of the beginning of the track with a fade-in of the length set in above step, with extra portion for further 5 seconds.

Press CLEAR to cancel the setting.

Continues to next page

3. Press COMPLETE.

The fade-in is added to the beginning of the track being played for the selected length.

Playback resumes from the beginning of the track the fade-in has been added to.

Notes

- Fade-in cannot be added to a track that is shorter than 21 seconds.
- The fade-in effect becomes ineffective if the following editing is performed to the track which the fade-in is added to.
 - Erasing a certain part of the track (Part Erase).
 - Combining the track (Track Combine).
 - Dividing the track (Track Divide).
 - Adjusting the beginning of the track (Track Adjust).
- If “Track Adjust” has been performed, the fade-in effect of both the adjusted track and the previous track becomes ineffective.

Add Fade Out

You can add fade-out at the end of a track. The end of the track is played with gradually lowering the level when fade-out has been added.

■ Editing during the stop mode**1. Select and confirm “Add Fade Out” in step 5 of “Editing during the stop mode” on page 39.**

The following message appears on the display.

Disc that contains the track to add fade-out

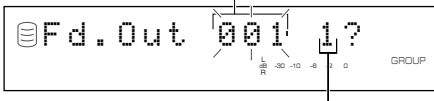

Track to add fade-out

The disc number that contains the track to add fade-out flashes.

2. Select the disc that contains the track to add fade-out by rotating the MULTI JOG knob (pressing +/- on the remote control).**3. Press the MULTI JOG knob (ENTER on the remote control) to confirm the disc that contains the track to add fade-out.**

The number of the track to add fade-out flashes.

Press **CLEAR** to cancel the confirmed selection.

4. Select the track to add fade-out by rotating the MULTI JOG knob (pressing +/- on the remote control).**5. Press the MULTI JOG knob (ENTER on the remote control) to confirm the track to add fade-out.**

The ending of the track for 8 seconds is repeatedly played with a 3-second (initial setting) fade-out.

The following message appears on the display.

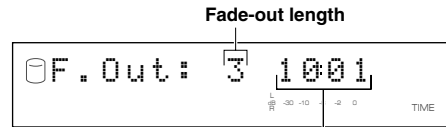

Playing time of the track

6. Rotate MULTI JOG knob (+/- on the remote control) to set the fade-out length.

The fade-out length can be set in the 1 to 10 second range by 1-second steps.

If you stop rotating the **MULTI JOG** knob, this unit starts repeated playback of the ending of the track with a fade-out of the length set in above step, with extra portion for further 5 seconds.

Press **CLEAR** to cancel the setting.

7. Press COMPLETE.

The fade-out is added to the end of the selected track for the selected length.

This unit returns to the editing menu item selection.

Continues to next page

■ Editing during playback

1. Select and confirm “Add Fade Out” in step 2 of “Editing during playback” on page 39.

The ending of the track for 8 seconds is repeatedly played with a 3-second (initial setting) fade-out.

The following message appears on the display.

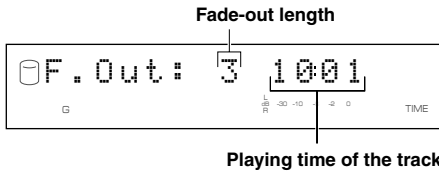

2. Rotate MULTI JOG knob (+/- on the remote control) to set the fade-out length.

The fade-out length can be set in the 1 to 10 second range by 1-second steps.

If you stop rotating the MULTI JOG knob, this unit starts repeated playback of the ending of the track with a fade-out of the length set in above step, with extra portion for further 5 seconds.

Press CLEAR to cancel the setting.

3. Press COMPLETE.

The fade-out is added to the ending of the track being played for the selected length.

Playback resumes from the beginning of the track the fade-out has been added to.

Notes

- Fade-out cannot be added to a track that is shorter than 21 seconds.
- The fade-out effect becomes ineffective if the following editing is performed to the track which the fade-out is added to.
 - Erasing a certain part of the track (Part Erase).
 - Combining the track (Track Combine).
 - Dividing the track (Track Divide).
 - Adjusting the beginning of the track (Track Adjust).
- If “Track Adjust” has been performed, the fade-out effect of both the adjusted track and the previous track becomes ineffective.

Track Title

You can assign a title to a track.

■ Editing during the stop mode

1. Select and confirm “Track Title” in step 5 of “Editing during the stop mode” on page 39.

The following message appears on the display.

Disc that contains the track to assign a title to

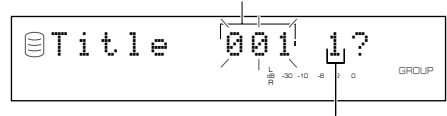

Track to assign a title to

The disc number that contains the track to assign a title to flashes.

2. Select the disc that contains the track to assign a title to by rotating the MULTI JOG knob (pressing +/- on the remote control).

3. Press the MULTI JOG knob (ENTER on the remote control) to confirm the disc that contains the track to assign a title to.

When the disc has been confirmed, the disc number that contains the track to assign a title to flashes.

Press CLEAR to cancel the confirmed selection.

4. Select the track to assign a title to by rotating the MULTI JOG knob (pressing +/- on the remote control).

5. Press the MULTI JOG knob (ENTER on the remote control) to confirm the track to assign a title to.

The following message appears on the display.



The cursor flashes.

If the selected track already has a title, the title appears on the display.

Continues to next page

6. Enter the title characters by using the **MULTI JOG knob** or the **alphabetical/numeric buttons on the remote control**.

See description on right for entering procedure.

7. Press **COMPLETE** when all the characters have been entered.

The title is assigned to the selected track.

This unit returns to the editing menu item selection.

■ Editing during playback

1. Select and confirm “Track Title” in step 2 of “Editing during playback” on page 39.

The track being played is confirmed for assigning the title to.

The following message appears on the display.



The cursor flashes.

If the selected track already has a title, the title appears on the display.

2. Enter the title characters by using the **MULTI JOG knob** or the **alphabetical/numeric buttons on the remote control**.

See description on right for entering procedure.

3. Press **COMPLETE** when all the characters have been entered.

The title is assigned to the track being played.

Playback starts from the beginning of the track with the title assigned to.

■ Entering the title characters by using the MULTI JOG knob

1. Rotate the **MULTI JOG knob clockwise**.

When the **MULTI JOG knob** is rotated clockwise, characters appear in the order of alphabetical capital letters, alphabetical lower case letters, numbers, and symbols. Select the character you wish to use for the title.

2. Press the **MULTI JOG knob** to confirm the selected character.

The cursor moves to the next space. Repeat steps 1 and 2 until the title is complete. A title can contain up to 32 characters.

■ Entering the title characters by using the alphabetical/numeric buttons on the remote control

1. Select the character to be used for the title by using the **alphabetical/numeric buttons on the remote control**.

Alphabetical capital letters, alphabetical lower case letters, and numbers switch each time the buttons are pressed. To create a space, press **SPACE**. To use a symbol, press **SYMBOL** to select the desired symbol.

2. Select the next character by pressing one of the **alphabetical/numeric buttons**.

The cursor automatically moves to the next space. When the same button is used, press **▷▷** to move the cursor to the next space.

Note

- If a new character is entered on the existing character, the new character is inserted in front of the existing character.

■ Correcting the characters

Move the cursor to the character to be corrected by pressing **◀◀/▶▶** or **▶▶/▶▶** (**◀◀** or **▶▶** on the remote control). Press **CLEAR** to cancel the character before a new character is entered. Then enter and confirm the new character.

You can do various editing operations on the discs that have been recorded on the HDD.

Disc Editing Operation

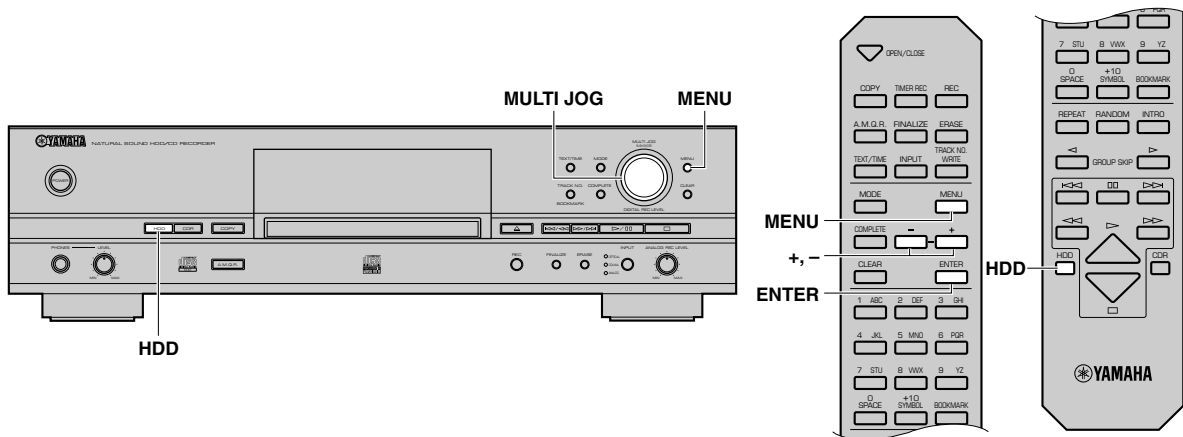

■ Editing during the stop mode

1. Press **HDD** to select the HDD to edit.
2. Press **MENU**.
The display changes for the menu item selection.
3. Select "Disc Edit" by rotating the **MULTI JOG knob** (pressing +/- on the remote control).



4. Press **MULTI JOG knob (ENTER on the remote control)**.
The display changes for the editing menu item selection.
5. Select the desired editing menu item by rotating the **MULTI JOG knob (pressing +/- on the remote control)**.

The followings are the disc editing menu items:

- Disc Rename
- Disc Erase
- Disc Combine
- Disc Divide
- Disc Pack
- Disc Title

6. Press **MULTI JOG knob (ENTER on the remote control)**.
The selected item is confirmed. Then editing operation can be started.

7. Start editing by following the detailed steps (pages 53—57) for each menu item.

8. Press **□** when all editing has been completed.
This unit returns to the stop mode.

■ Editing during playback

Press **MULTI JOG** knob to light up the **GROUP** indicator.

1. Press **MENU** while the disc to be edited is being played.
The display changes for the editing menu item selection.
2. Select the desired editing menu item by rotating the **MULTI JOG knob (pressing +/- on the remote control)**.
The followings are the disc editing menu items:
 - Disc Rename
 - Disc Erase
 - Disc Combine
 - Disc Divide
 - Disc Title
3. Press **MULTI JOG knob (ENTER on the remote control)**.
The selected item is confirmed. Then editing operation can be started.
4. Start editing by following the detailed steps (pages 53—57) for each menu item.

Notes

- If **MENU** is pressed during editing, entry of the selection is canceled, and then this unit returns to the following state;
 - This unit returns to the editing menu item selection if having started editing during the stop mode.
 - This unit returns to the playback of the disc to be edited if having started editing during playback.
- If **□** is pressed during editing, all entry of the selection is canceled, and this unit returns to the stop mode.

Disc Rename

You can move a disc and assign a new number.

■ Editing during the stop mode

1. Select and confirm “Disc Rename” in step 5 of “Editing during the stop mode” on page 52.

The following message appears on the display.



Disc to be moved

The disc number to be moved flashes.

2. Select the disc to be moved by rotating the MULTI JOG knob (pressing +/- on the remote control).
3. Press the MULTI JOG knob (ENTER on the remote control) to confirm the disc to be moved.

The display scrolls to the left to indicate the disc number to be moved and new number.

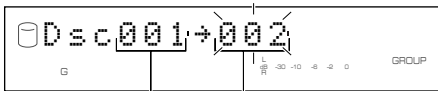

Disc to be moved New disc number

Press **CLEAR** to cancel the confirmed selection.

4. Select the new disc number to by rotating the MULTI JOG knob (pressing +/- on the remote control).
5. Press the MULTI JOG knob (ENTER on the remote control) to confirm the new disc number.

Press **CLEAR** to cancel the confirmed selection.

6. Press **COMPLETE**.

The selected disc has been moved to and assigned a new number.

This unit returns to the editing menu item selection.

■ Editing during playback

1. Select and confirm “Disc Rename” in step 2 of “Editing during playback” on page 52.

The disc being played is confirmed to be moved and assigned a new number.

The number of the disc being played and the new disc number appear on the display.

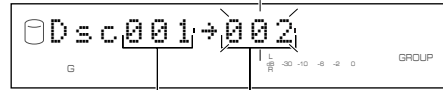

Disc being played New disc number

2. Select the new disc number to by rotating the MULTI JOG knob (pressing +/- on the remote control).
3. Press the MULTI JOG knob (ENTER on the remote control) to confirm the new disc number.

Press **CLEAR** to cancel the confirmed selection.

4. Press **COMPLETE**.

The disc being played has been moved to and assigned a new number.

Playback resumes from the beginning of the moved disc.

Notes

- If the selected new disc number is already in use, the disc numbers following this renumbered disc will be automatically up-numbered by one. However, if there is any unused disc number, only the discs up to that number will be up-numbered.
- The original number of the disc that has been renumbered will be available for future use.

Disc Erase

You can erase a selected disc.

■ Editing during the stop mode

1. Select and confirm “Disc Erase” in step 5 of “Editing during the stop mode” on page 52.

The following message appears on the display.



Disc to be erased

The number of the disc to be erased flashes.

2. Select the disc to be erased by rotating the MULTI JOG knob (pressing +/- on the remote control).
3. Press the MULTI JOG knob (ENTER on the remote control) to confirm the disc to be erased.

Press **CLEAR** to cancel the confirmed selection.

4. Press **COMPLETE**.

The selected disc is erased.

This unit returns to the editing menu item selection.

■ Editing during playback

1. Select and confirm “Disc Erase” in step 2 of “Editing during playback” on page 52.

The disc being played is confirmed to be erased.

2. Press **COMPLETE**.

The disc being played is erased.

Playback resumes from the beginning of the next disc after the erased disc. If no disc follows the erased disc, this unit plays the previous disc of the erased disc.

Note

- The number of the erased disc will be available for future use.

Disc Combine

You can combine a series of discs into one.

■ Editing during the stop mode

1. Select and confirm “Disc Combine” in step 5 of “Editing during the stop mode” on page 52.

The following message appears on the display.



Disc to be the first in the combination

The disc number to be the first in the combination flashes.

2. Select the disc to be the first track in the combination by rotating the MULTI JOG knob (pressing +/- on the remote control).

3. Press the MULTI JOG knob (ENTER on the remote control) to confirm the disc to be the first in the combination.

The display scrolls to the left to indicate the disc numbers to be the first and the last in the combination.

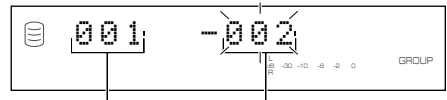

Disc to be the first in the combination

Disc to be the last in the combination

Press **CLEAR** to cancel the confirmed selection.

4. Select the disc to be the last in the combination by rotating the MULTI JOG knob (pressing +/- on the remote control).

5. Press the MULTI JOG knob (ENTER on the remote control) to confirm the disc to be the last in the combination.

Press **CLEAR** to cancel the confirmed selection.

6. Press **COMPLETE**.

The two selected discs and all those between are combined into one disc.

This unit returns to the editing menu item selection.

Continues to next page

■ Editing during playback

1. Select and confirm “Disc Combine” in step 2 of “Editing during playback” on page 52.

The disc being played is confirmed to be the first disc in the combination.

The number of the disc being played and the number of the disc to be the last in the combination appear on the display.

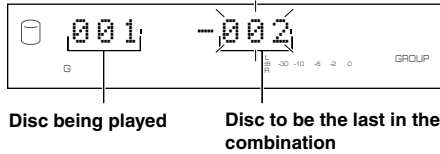

2. Select the disc to be the last in the combination by rotating the MULTI JOG knob (pressing +/- on the remote control).

3. Press the MULTI JOG knob (ENTER on the remote control) to confirm the disc to be the last in the combination.

Press **CLEAR** to cancel the confirmed selection.

4. Press COMPLETE.

The two selected discs and all those between are combined into one disc.

Playback resumes from the beginning of the combined disc.

Cautions

- One disc can contain up to 99 tracks. When the total track number on a disc exceeds 99, “Track No.Full” appears on the display.
- The maximum length of one disc on the HDD is 99 minutes 59 seconds. When the total time of the discs to be combined exceeds 99 minutes 59 seconds, “No Enough Spc” appears on the display.

Notes

- When combining a series of discs, the selected disc numbers following the selected first disc will be available for future use.
- The disc title for the first disc is effective for the combined disc.

Disc Divide

You can divide a disc into two at the selected point.

■ Editing during the stop mode

1. Select and confirm “Disc Divide” in step 5 of “Editing during the stop mode” on page 52.

The following message appears on the display.

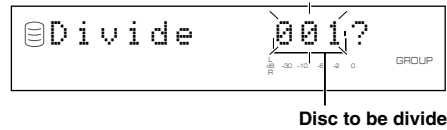

The number of the disc to be divided flashes.

2. Select the disc to be divided by rotating the MULTI JOG knob (pressing +/- on the remote control).

3. Press the MULTI JOG knob (ENTER on the remote control) to confirm the disc to be divided.

“Div.from” and the dividing point (the number of the track to be the first after dividing) appear on the display.

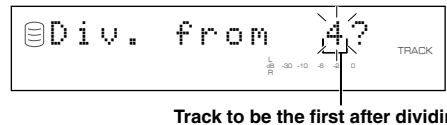

Press **CLEAR** to cancel the confirmed selection.

4. Select the dividing point by rotating the MULTI JOG knob (pressing +/- on the remote control).

5. Press the MULTI JOG knob (ENTER on the remote control) to confirm the dividing point.

Press **CLEAR** to cancel the confirmed selection.

6. Press COMPLETE.

The selected disc is divided into two at the selected dividing point.

This unit returns to the editing menu item selection.

Continues to next page

■ Editing during playback

1. Select and confirm “Disc Divide” in step 2 of “Editing during playback” on page 52.

The disc being played is confirmed to be divided. “Div.from” and the dividing point (the number of the track to be the first after dividing) appear on the display.



Track to be the first after dividing

2. Select the dividing point by rotating the MULTI JOG knob (pressing +/- on the remote control).

3. Press the MULTI JOG knob (ENTER on the remote control) to confirm the dividing point.

Press **CLEAR** to cancel the confirmed selection.

4. Press COMPLETE.

The disc being played is divided into two at the set dividing point. Playback resumes from the beginning of the second disc of the two divided discs.

Caution

- The HDD can contain up to 999 discs. If the HDD already contains 999 discs, “Disc No.Full” appears on the display.

Note

- The disc numbers following the divided disc will be up-numbered by one. However, if there is any unused disc number, only the discs up to that number will be up-numbered.

Before “Disc Divide” is performed

| | | | | | |
|------------------|---|---|---|---|---|
| 1 | 2 | | 4 | 5 | 6 |
| Divided into two | | | | | |
| 1 | 2 | 3 | 4 | 5 | 6 |

After “Disc Divide” has been performed (dividing a disc into two)

☐ : Space not being used

Disc Pack

You can re-organize the disc numbers by eliminating unused disc numbers that have been created by changing disc numbers or erasing discs.

1. Select and confirm “Disc Pack” in step 5 of “Editing during the stop mode” on page 52.

The following message appears on the display.

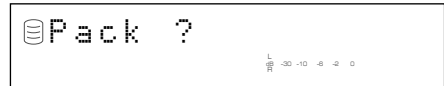

2. Press COMPLETE.

The disc numbers are re-organized by eliminating unused disc numbers.

This unit returns to the editing menu item selection.

Before “Disc Pack” is performed

| | | | | | |
|---|---|---|---|---|---|
| 1 | | 3 | 4 | | 6 |
| 1 | 2 | 3 | 4 | 5 | 6 |

After “Disc Pack” has been performed (Unused disc numbers have been eliminated.)

☐ : Unused disc numbers

Disc Title

You can assign a title to a recorded disc.

■ Editing during the stop mode

1. Select and confirm “Disc Title” in step 5 of “Editing during the stop mode” on page 52.

The following message appears on the display.



Disc to assign a title to

The number of the disc to assign a title to flashes.

2. Select the disc to assign a title to by rotating the MULTI JOG knob (pressing +/- on the remote control).

3. Press the MULTI JOG knob (ENTER on the remote control) to confirm the disc to assign a title to.

The following message appears on the display.



The cursor flashes.

If the selected disc already has a title, the title appears on the display.

4. Enter the title characters by using the MULTI JOG knob or the alphabetical/numeric buttons on the remote control.

See description on right for entering procedure.

5. Press COMPLETE when all the characters have been entered.

The title is assigned to the selected disc.

This unit returns to the editing menu item selection.

■ Editing during playback

1. Select and confirm “Disc Title” in step 2 of “Editing during playback” on page 52.

The disc being played is confirmed for assigning the title to.

The following message appears on the display.



The cursor flashes.

If the selected disc already has a title, the title appears on the display.

2. Enter the title characters by using the MULTI JOG knob or the alphabetical/numeric buttons on the remote control.

See description below for entering procedure.

3. Press COMPLETE when all the characters have been entered.

The title is assigned to the disc being played.

Playback resumes from the beginning of the disc with the title assigned to.

■ Entering the title characters by using the MULTI JOG knob

1. Rotate the MULTI JOG knob clockwise.

When the MULTI JOG knob is rotated clockwise, characters appear in the order of alphabetical capital letters, alphabetical lower case letters, numbers, and symbols. Select the character you wish to use for the title.

2. Press the MULTI JOG knob to confirm the selected character.

The cursor moves to the next space. Repeat steps 1 and 2 until the title is complete. A title can contain up to 32 characters.

■ Entering the title characters by using the alphabetical/numeric buttons on the remote control

1. Select the character to be used for the title by using the alphabetical/numeric buttons on the remote control.

Alphabetical capital letters, alphabetical lower case letters, and numbers switch each time the buttons are pressed. To create a space, press SPACE. To use a symbol, press SYMBOL to select the desired symbol.

2. Select the next character by pressing one of the alphabetical/numeric buttons.

The cursor automatically moves to the next space. When the same button is used, press >>> to move the cursor to the next space.

Note

- If a new character is entered on the existing character, the new character is inserted in front of the existing character.

■ Correcting the characters

Move the cursor to the character to be corrected by pressing <<</>>> or >>>/>>> (<<< or >>> on the remote control). Press CLEAR to cancel the character before a new character is entered. Then enter and confirm the new character.

UNDO FUNCTION

You can cancel an operation and the result of a previous editing step on this unit (Undo function).

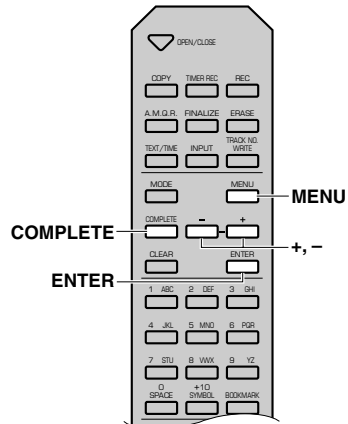
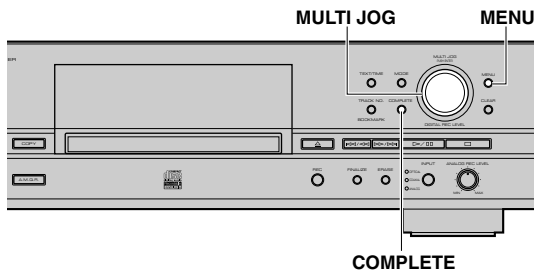

1. Press MENU to display the menu item selection while this unit is in the stop mode.
2. Select "Undo" by rotating the MULTI JOG knob (pressing +/- on the remote control).



3. Press the MULTI JOG knob (ENTER on the remote control) to display "Undo?".
4. Press COMPLETE.

The previous editing operation and result are canceled.

The undo function does not work if any of the following operations has been performed after the editing operation.

- After the editing operation, a recording has been made, or this unit has been set in the recording pause mode to start recording.
- After the editing operation, a copy has been made, or this unit has been set in the copy standby mode to start copying.
- Further editing operations have been performed.
- The HDD has been formatted.

The following message appears on the display if the undo function does not work.

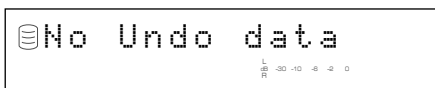

Notes

- The undo function does not apply to the addition of fade-in or fade-out to a track because it can be canceled at any time.
- The undo function does not apply to assigning a title to an album, track or disc.

BOOKMARK

While playing a track, you can place a bookmark temporarily on the track. Bookmark is convenient for immediate playback of the desired track and for creating a new album since the tracks with bookmarks are stored as a playlist.

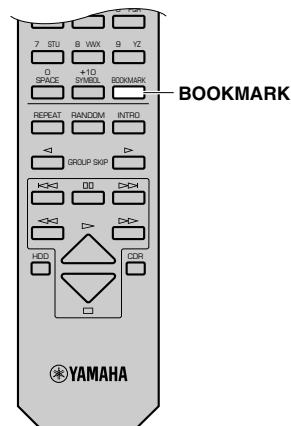
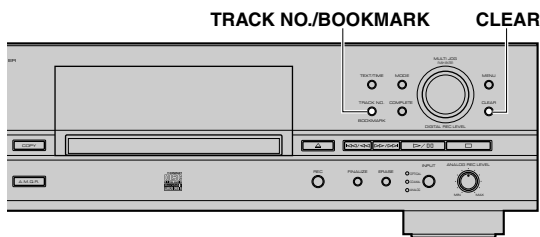

■ To place a bookmark

Press **TRACK NO./BOOKMARK** (**BOOKMARK** on the remote control) to place a bookmark during playback of the track. The **MARK** indicator lights on the display.



Notes

- When the track with a bookmark is selected, the **MARK** indicator lights on the display regardless of whether it is during playback or stopped.
- You can create one list of the tracks with bookmarks on each the HDD and a CD.
- The list of the tracks on the HDD with bookmarks will be stored on the HDD. However, only one list of tracks with bookmarks can be stored. If you wish to have more than one list, copy the playlist in the album (see page 32).
- The list of the tracks on a CD with bookmarks will be erased if the CD is taken out or the power of this unit is turned off.
- You can create a new album by copying the list of tracks with bookmarks. Select "Mark" as the group to be copied. See "Album Copy" on page 32.

■ To cancel a bookmark

Press **TRACK NO./BOOKMARK** (**BOOKMARK** on the remote control) to cancel the bookmark during playback of the track. The **MARK** indicator turns off on the display.

■ To cancel all bookmarks on the operating drive

Press **CLEAR** as pressing **TRACK NO./BOOKMARK** on the front panel while this unit is in the stop mode. The following message appears on the display, and all bookmarks are canceled.

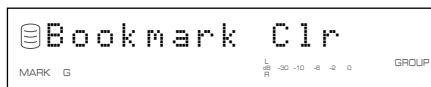

COPYING FROM THE HDD ONTO A CD-R OR CD-RW DISC

Copying a Whole Group (Disc, Album or Bookmark)

You can copy all tracks in a whole group of discs, albums or a bookmark.

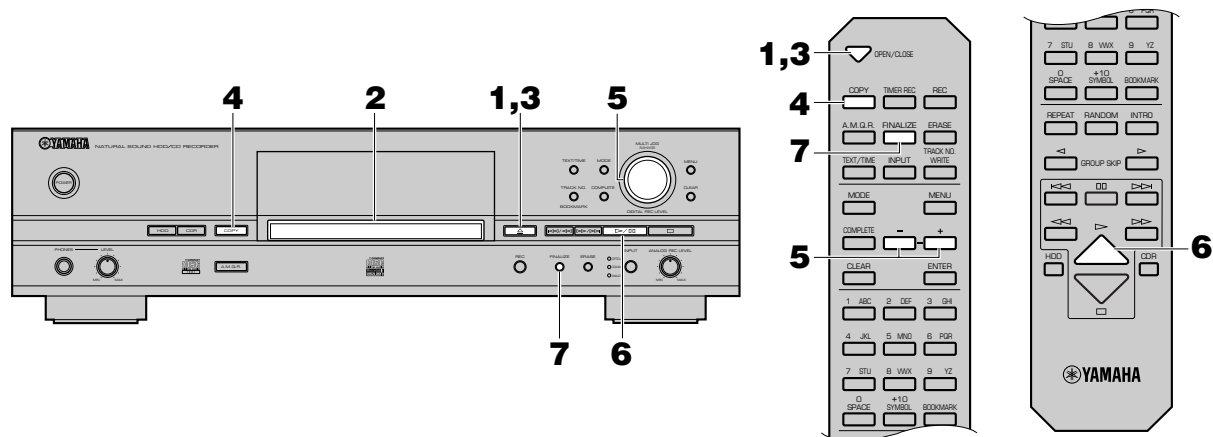

1. Press Δ (OPEN/CLOSE on the remote control) to open the disc tray.
2. Load a new CD-R or CD-RW disc, or a CD-R or CD-RW disc without finalization on the disc tray. Place the CD-R or CD-RW disc correctly aligned in the recessed area of the disc tray with its recordable side facing down.

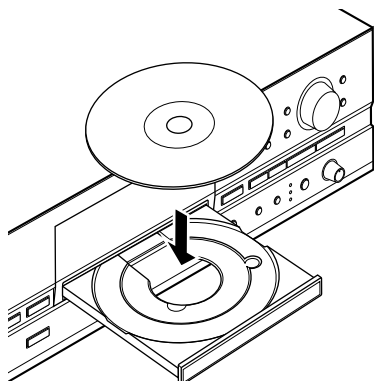

3. Press Δ (OPEN/CLOSE on the remote control) to close the disc tray.

Note

- The disc tray can be also closed by pressing the front edge of the disc tray gently. If a CD-R or CD-RW disc without finalization is loaded, this unit starts playback of that CD-R or CD-RW disc. Press \square to stop playback.

This unit starts reading the information (type and capacity of a CD-R or a CD-RW disc) when a CD-R or a CD-RW disc is loaded. It takes approximately 10 to 15 seconds to complete the reading. The following message appears on the display during the reading.



When reading the information has been completed, the display changes as follows, and this unit becomes ready for operation.

When copying onto a CD-R or CD-RW disc without finalization

The number of recorded tracks Total recorded time

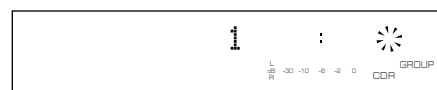
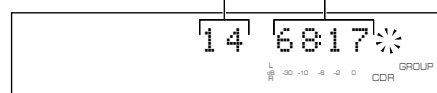

When copying onto a new CD-R or CD-RW disc

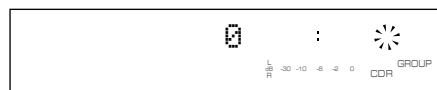
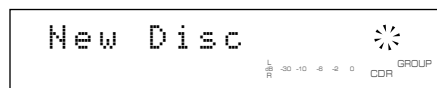

4. Press COPY twice.

The following message appears on the display, and this unit enters in the copy standby mode. Copying has not been started yet at this stage.



5. Select the group on the HDD to be copied.

Rotate the **MULTI JOG** knob (press +/- on the remote control) to select the group on the HDD to be copied.

When a disc is selected:



When an album is selected:



When a bookmark is selected:

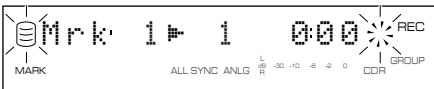

6. Start copying.

Press >/00 (> on the remote control) to start copying.



Notes

- OPC may start on the loaded CD-R or CD-RW disc depending on its recording condition. It takes approximately 15 seconds to complete the adjustment.



When the adjustment has been completed, and the message above turns off on the display, copying automatically starts.

- The progress of elapsed time for the track being copied may vary by the data processing inside this unit.

To cancel copying, press □.

Caution

- If copying is canceled by □ being pressed, only the data that has been recorded on the CD-R or CD-RW disc before the cancellation remains on the disc. When "Digital Move" (see page 65) is selected, the original data on the HDD which has already been copied to a CD-R or CD-RW disc will be deleted.

When copying has been completed, the operation of the HDD and the CD automatically stops.

7. Press FINALIZE to start finalization.

See page 70 for finalization.

Text data

If the copied data contains text data that can be copied such as a disc title, the **TOC** indicator flashes when copying is completed. If you attempt to open the disc tray by pressing △ (**OPEN/CLOSE** on the remote control), "TEXT Save ?" appears on the display.

- In order to copy the text data, perform finalization procedure.
- In order to open the disc tray without copying the text data, press △ (**OPEN/CLOSE** on the remote control) again. However once the disc tray is opened, text data cannot be copied.

Copying Favorite Tracks on the HDD

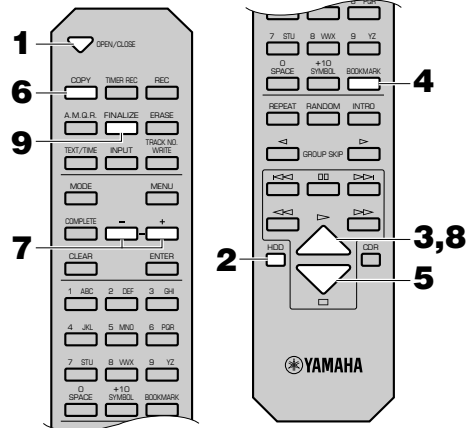
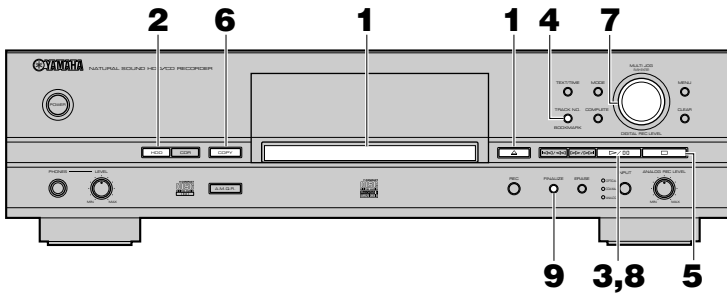

1. Load a new CD-R or CD-RW disc, or a CD-R or CD-RW disc without finalization.

Press **△** (**OPEN/CLOSE** on the remote control) to open the disc tray, and place a CD-R or CD-RW disc with its recordable side facing down. Then press **△** (**OPEN/CLOSE** on the remote control) to close the disc tray.

If there are tracks with bookmarks already, go to step 6.

2. Press HDD to select HDD.

3. Start playback of a track recorded on the HDD.

Press **▷/⏪** (**▷** on the remote control) to start playback.

4. Press TRACK NO./BOOKMARK (BOOKMARK on the remote control) while your favorite track is being played.

The **MARK** indicator lights up on the display.



Press **◀◀/▶▶** or **▶▶/▶▶** (**◀◀** or **▶▶** on the remote control) to skip tracks and repeat this operation.

To cancel a bookmark

Press **TRACK NO./BOOKMARK** (**BOOKMARK** on the remote control) to cancel the bookmark during playback of the track. The **MARK** indicator turns off on the display.

5. When the bookmarks have been placed to all favorite tracks, press □ to stop playback.

Tracks are listed and stored in order that the bookmarks have been placed.

To cancel all bookmarks

Press **CLEAR** as pressing **TRACK NO./BOOKMARK** on the front panel while this unit is in the stop mode. "Bookmark Clr" appears on the display and all bookmarks are canceled.

6. Press COPY twice.

This unit enters the copy standby mode. Copying has not been started yet at this stage.

7. Rotate the MULTI JOG knob (press +/- on the remote control) to select "Mrk".



8. Start copying.

Press **▷/⏪** (**▷** on the remote control) to start copying.

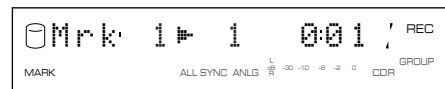

Note

- OPC may start on the loaded CD-R or CD-RW disc depending on its recording condition. It takes approximately 15 seconds to complete the adjustment. When the adjustment is completed and "OPC Adjust" disappears, copying will automatically start.

When copying has been completed, the operation of the HDD and the CD automatically stops.

9. Press FINALIZE to perform finalization.

See page 70 for finalization.

High Quality Copying

You can make your own CD with high quality sound with the Audio Master Quality Recording mode.

Cautions

- Audio Master Quality Recording mode can be used only for copying from the HDD on a new CD-R disc.
- Recordable time is 63 minutes for a 74-minute CD-R disc, and 68 minutes for a 79-minute CD-R disc.
- Audio Master Quality Recording mode cannot be used for recording from an external component directly to a CD-R disc.

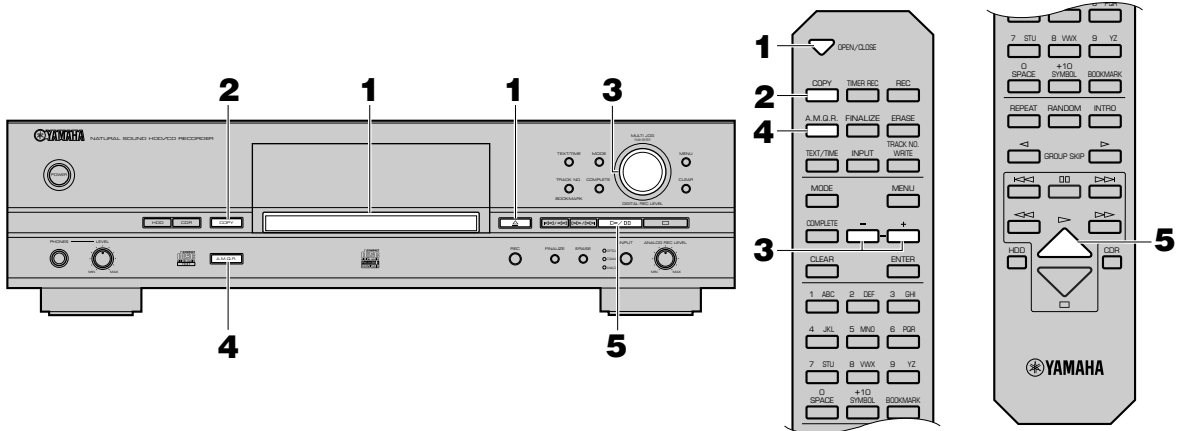

1. Load a new CD-R disc.

Press \triangle (OPEN/CLOSE on the remote control) to open the disc tray, and place a CD-R disc with its recordable side facing down. Then press \triangle (OPEN/CLOSE on the remote control) to close the disc tray.

2. Press COPY twice.

This unit enters the copy standby mode. Copying has not been started yet at this stage.

3. Select the group on the HDD to be copied.

Rotate the MULTI JOG knob (press +/- on the remote control) to select the group on the HDD to be copied.

4. Press A.M.Q.R.

The A.M.Q.R. indicator lights up on the display.



5. Start copying.

Press \triangleright / \square (\triangleright on the remote control) to start copying.



The copying conditions are as follows:

- Copy Method: "Digital Move"
- Copy Level: 0dB
- Copy Speed: 4x speed

Cautions

- Once copying starts, no button operation is effective until copying is completed.
- Never turn off the power of this unit or unplug the AC power cord during copying.

When copying has been completed, the operation of the HDD and the CD automatically stops.

Cautions

- When total time of the group to be copied exceeds recordable time on a CD-R disc (63 minutes for a 74-minute CD-R disc and 68 minutes for a 79-minute CD-R disc), the following message appears on the display. In this case, Audio Master Quality Recording mode cannot be used.



- If you select the album with its tracks' level adjusted as the group to be copied, the following message appears on the display. In this case, Audio Master Quality Recording mode cannot be used.



- When a CD-R disc other than a 74-minute, 79-minute or 4x writing compatible CD-R disc is loaded, or a CD-RW disc is loaded on this unit, the following message appears on the display. In this case, Audio Master Quality Recording mode cannot be used.



Advanced Operations

■ Setting the copying mode

This unit provides various copying modes. Choose the one that suits your needs.

Initial setting: All Synchro

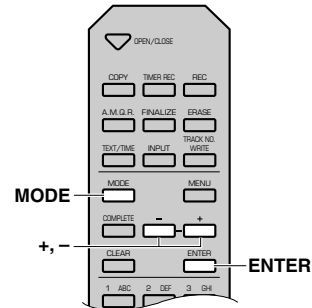
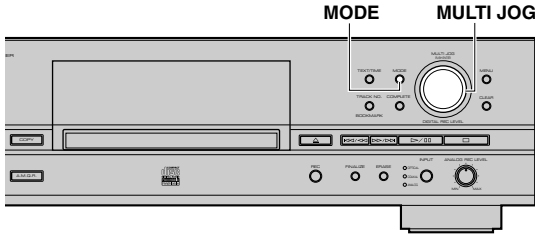

1. Press **MODE** while this unit is in the copy standby mode.

You can select the copying mode.

2. Rotate the **MULTI JOG knob (press +/- on the remote control)** to select the copying mode.

Choose one of the modes listed below.

All Synchro (All-synchronized copying mode)

This mode copies all of the material from a single audio source at the same time as the source programs are being played. Track markers are automatically placed between the tracks being recorded.

Full Auto (Full auto-synchronized copying mode)

This mode automatically performs finalization after all synchronized copying is complete. A CD-R disc can be played as a CD as soon as finalization has been completed.

Multi Synchro (Multi-synchronized copying mode)

This mode copies the set number of tracks at the same time as the source programs are being played. The number of tracks to be recorded can be set in the range of 1 to 99 tracks. This mode is convenient to record a mix of tracks from different sources.

3. Press the **MULTI JOG knob (ENTER on the remote control)** to confirm the copying mode selected.

If "All Synchro" or "Full Auto" is confirmed, this unit returns to the copy standby mode.

If "Multi Synchro" is confirmed, the following message appears on the display. Go to step 4.



4. Select the number of tracks by rotating the **MULTI JOG knob (pressing +/- on the remote control)**.

The number can be selected in the 1 to 99 tracks range.

5. Press the **MULTI JOG knob (ENTER on the remote control)** to confirm the number selected.

This unit returns to the copy standby mode.

6. Select a group and track to start copying from.

Rotate the **MULTI JOG knob** to select a group and track to start copying with. Select a group while the **GROUP** indicator lights and a track while the **TRACK** indicator lights. Rotate the **MULTI JOG knob** to switch the indicators.

■ Copying menu setting

You can make detailed settings on the menu for your copying. Follow the steps described below for menu setting.

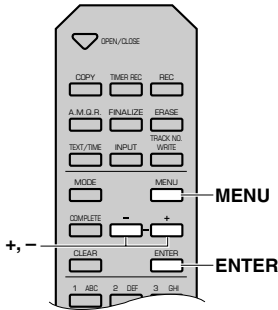
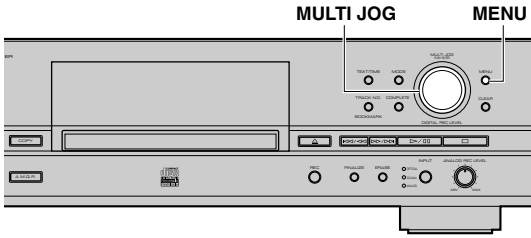

- 1. Press MENU while this unit is in the copy standby mode.**
You can start setting the copying menu.
- 2. Select the menu item to be set by rotating the MULTI JOG knob (pressing +/- on the remote control).**
The copying menu contains 3 items as follows:
 - Copy Method (setting the copying method)
 - Copy Level (setting the copying level)
 - Copy Speed (setting the copying speed)
- 3. Press the MULTI JOG knob (ENTER on the remote control) to confirm the menu item to be adjusted.**
- 4. Adjust the parameter for each item by rotating the MULTI JOG knob (pressing +/- on the remote control).**
See the further steps for detailed instructions on parameter adjustment for each item.
- 5. Press the MULTI JOG knob (ENTER on the remote control) to confirm the setting when adjustment has been completed.**
- 6. Press MENU to close the menu.**
This unit returns to the copy standby mode.

■ Copy Method

Setting of the copying method. Copying may fail if the setting for "Copy Method" is not correctly made.



Initial setting: Analog Copy

Analog Copy

This method always makes analog copies.

Digital Move

The data is moved from the HDD to the CD. Therefore, the track or group data will be deleted from the HDD after they have been moved to the CD-R or CD-RW disc by this method.

Digital Copy

This method always makes digital copies. Copying is not possible if the tracks are copy protected by the SCMS standard (see page 5).

Auto Dig/Anlg

Digital and analog copying are automatically switched depending on the track. If digital copying is prohibited by the SCMS standard (see page 5), an analog copy is made. For those tracks that can be digitally copied, a digital copy is made.

Notes

- In analog copying, the data may be copied at a lower sound level.
- The settings is stored in the memory and applied to future copying.

■ Copy Level

Setting of the sound level for copying. Sound level adjustment is not normally necessary. However it is possible to adjust the copying sound level to suit you needs.



The following message appears on the display when “Copy Level” setting is confirmed in step 3 for “Copying menu setting” on page 65.

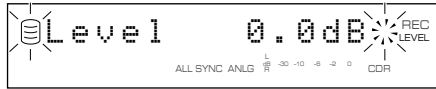

1. Adjust the copying sound level by rotating the MULTI JOG knob (pressing +/- on the remote control).

Adjustment is possible in the -12dB to +12dB range by 0.4dB steps.

2. Press the MULTI JOG knob (ENTER on the remote control) to confirm the copying level setting.

Notes

- Level adjustment is not possible during copying.
- If the red part on the peak level meter lights at the loudest sound levels, stop copying to adjust the copying level, and then resume copying.



- If the level is adjusted, copying speed is made at maximum 2x speed.

■ Copy Speed

Setting of the copying speed.



Initial setting: Best Effort

Best Effort

Copying is made at the maximum speed possible depending on the “Copy Method” and “Copy Level” settings, and the conditions of a CD-R or CD-RW disc.

- When “Auto Dig/Anlg” is selected: maximum 2x speed
- When “Digital Move” is selected: maximum 8x speed (CD-R)
maximum 4x speed (CD-RW)
- When “Digital Copy” is selected: maximum 8x speed (CD-R)
maximum 4x speed (CD-RW)
- When “Analog Copy” is selected: maximum 2x speed

1x Copy

Copying is always made at 1x speed despite the “Copy Method” and “Copy Level” settings.

2x Copy

Copying is always made at 2x speed despite the “Copy Method” and “Copy Level” settings.

Notes

- Depending on the condition of the CD-R or CD-RW disc, the copy speed may drop automatically even when “Best Effort” is selected.
- Select “2x Copy” or “1x Copy” when copying onto a CD-R or CD-RW disc that does not support high-speed copying.
- The settings is stored in the memory and applied to future copying.

RECORDING FROM AN EXTERNAL COMPONENT ONTO A CD-R OR CD-RW DISC

You can record from an external component directly to a CD-R or CD-RW disc. Following is an explanation for digital recording from an external CD player connected to the **DIGITAL IN (OPTICAL)** or **DIGITAL IN (COAXIAL)** jacks on this unit.

Note

- Before starting to record, check the remaining time available for recording on the CD-R or CD-RW disc (see page 11).

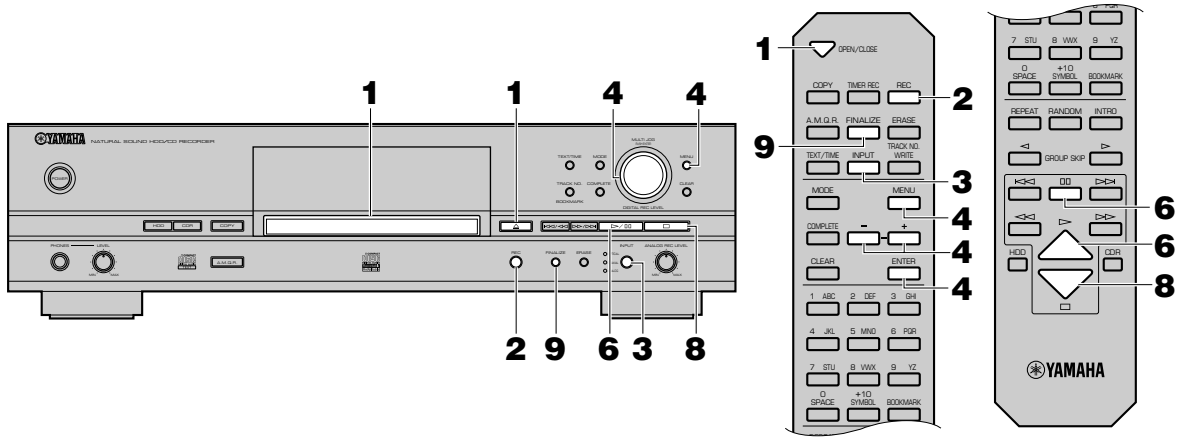

1. Load a new CD-R or CD-RW disc, or a CD-R or CD-RW disc without finalization.

Press Δ (**OPEN/CLOSE** on the remote control) to open the disc tray, and place a CD-R or CD-RW disc with its recordable side facing down. Then press Δ (**OPEN/CLOSE** on the remote control) to close the disc tray.

2. Press REC.

OPC may start on the loaded CD-R or CD-RW disc depending on its recording condition. It takes approximately 15 seconds to complete the adjustment.

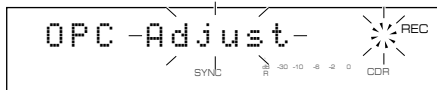

If this unit determines that OPC is not needed for the disc loaded, "Standby" flashes on the display.

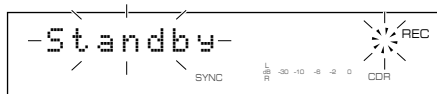

The following message appears on the display and this unit enters the recording pause mode.

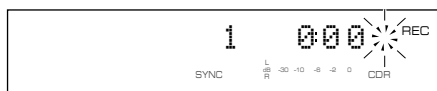

Note

- If you leave this unit in the recording pause mode for approximately 5 minutes, this unit returns to the stop mode automatically.

3. Select the input source to be recorded.

When making a digital recording from an external CD player, press **INPUT** until the **OPTICAL** or **COAXIAL** indicator lights up.

When making an analog recording...

Press **INPUT** until the **ANALOG** indicator lights up.

4. Adjust the recording level.

The adjustment of the digital recording level is not normally necessary. However it is possible to adjust the recording level to suit your needs.

Play the loudest passage (highest sound level) of the source to be recorded.

By pressing **MENU**, the display changes for the level adjustment. Rotate the **MULTI JOG** knob (press **+/-** on the remote control) to adjust the recording level. When the adjustment is completed, press **MULTI JOG** knob (**ENTER** on the remote control) to confirm the adjusted recording level.

When making an analog recording...

Rotate the **ANALOG REC LEVEL** control to adjust the recording level.

Note

- Adjust the recording level so that the red part on the peak level meter does not light at the loudest sound levels.

See "Adjusting the Recording Level" on page 24 for details.

5. Select a recording mode.

If you wish to record only one track, select "Multi Synchro" and set to 1 track for the number of tracks to be recorded.

If you wish to start and stop recording, and place track markers automatically, select "All Synchro".

If you wish to automatically make finalization on a CD-R or CD-RW disc as well, select "Full Auto".

See "Setting the recording mode" on page 69 for details.

6. Start recording.

Press ▷/00 (▷ or 00 on the remote control) to start recording.



Note

- In the multi-synchronized, all-synchronized, or full auto-synchronized recording mode, this unit automatically starts recording when the source component starts playback.

7. Start playback on an external CD player.

Press ▷/00 (00 on the remote control) to stop recording temporarily. "Wait" flashes on the display. The **CDR** mark starts flashing in a few seconds and the track number is advanced to the next.

Press ▷/00 (▷ or 00 on the remote control) to resume recording.

8. Press □ to stop recording.

"Wait" flashes on the display. The number of recorded tracks and the total recorded time are indicated on the display in a few seconds, and then the first track number of the recorded tracks is indicated on the display in a few seconds.

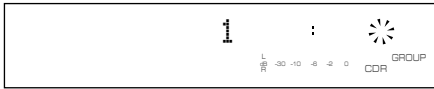

9. When all recordings are completed, press FINALIZE to start finalization.

See page 70 for finalization.

CD TEXT

Even if a CD with CD TEXT that can be copied is recorded from an external player, CD TEXT will not be copied. In order to copy CD TEXT, copy it on the HDD (page 14) first, then copy it on a CD-R or CD-RW disc (page 60), or duplicate a CD (page 72).

IMPORTANT

- Never turn off the power of this unit during recording. Recording may not be correctly made, or the CD-R or CD-RW disc may be damaged.
- If the power of this unit is turned off during recording on a CD-R disc, recording may become impossible or the CD-R disc may not be played back normally because information is not written in the PMA (Program Memory Area).
- During recording, make sure that this unit is not subjected to shock or vibration as it may cause skips or jumps to be included in the recording.

Notes

- It is recommended to record a program such as a cable TV broadcasting onto the HDD first. Then edit it on the HDD and copy it on a CD-R or CD-RW disc. You can make your original CD with less mistakes. See page 20 for recording onto the HDD and page 29 for editing.
- This unit can duplicate a CD quickly. See page 72 for duplicating a CD.

Advanced Operations

■ Setting the recording mode

This unit provides various recording modes. Choose the one that suits your needs.

Initial setting: Track Synchro

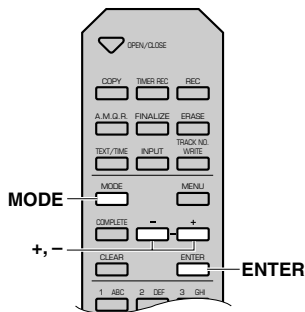
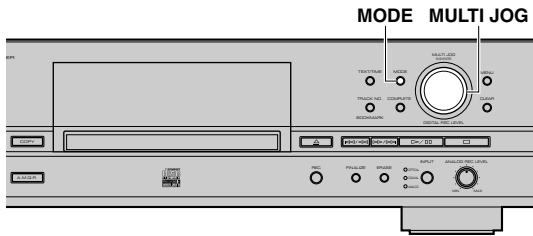

1. Press **MODE** while this unit is in the recording pause mode.

The recording mode can be selected.

2. Rotate the **MULTI JOG** knob (press +/- on the remote control) to select the recording mode.

Choose one of the modes listed below.

Manual (Manual recording mode)

All the recording operations including starting, stopping, track marking and finalization are performed manually.

Track Synchro (Track-synchronized recording)

Recording is started and stopped manually. Track markers are automatically placed by detecting track intervals.

Multi Synchro (Multi-synchronized recording mode)

This mode records the set number of tracks at the same time as the source programs are being played. The number of tracks to be recorded can be set in the range of 1 to 99 tracks. This mode is convenient to record a mix of tracks from different sources.

All Synchro (All-synchronized recording mode)

This mode records all of the material from a single audio source at the same time as the source programs are being played. Track markers are automatically placed between the tracks being recorded.

Full Auto (Full auto-synchronized recording mode)

This mode automatically performs finalization after all synchronized recording is complete. A CD-R disc can be played as a CD as soon as finalization has been completed.

Auto Period (Auto-period recording mode)

This mode makes recording for the set amount of time while placing track markers at the set time interval. The length between track markers can be adjusted in the 10 seconds to 30 minutes range by 10-second steps. This mode is convenient to search for material recorded from FM broadcasts.

3. Press the **MULTI JOG** knob (**ENTER** on the remote control) to confirm the recording mode selected. If "Manual", "Track Synchro", "All Synchro" or "Full Auto" is confirmed, this unit returns to the recording pause mode. If "Multi Synchro" is confirmed, the following message appears on the display. Make a setting following steps 4 and 5.



When "Auto Period" is confirmed, the following message appears on the display. Make a setting following steps 6—9.

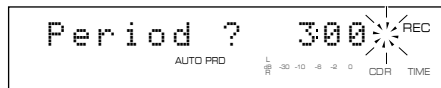

4. Select the number of tracks by rotating the **MULTI JOG** knob (pressing +/- on the remote control).

The number can be set in the 1 to 99 tracks range.

5. Press the **MULTI JOG** knob (**ENTER** on the remote control) to confirm the number of tracks to be set.

This unit returns to the recording pause mode.

6. Select the time length between track markers by rotating the **MULTI JOG** knob (pressing +/- on the remote control).

The time length can be set in the 10 seconds to 30 minutes range by 10-seconds steps.

7. Press the **MULTI JOG** knob (**ENTER** on the remote control) to confirm the time length between the selected track markers.

The following message appears on the display. The total recording time can be set.

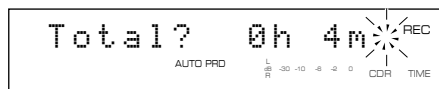

8. Select the total recording time by rotating the **MULTI JOG** knob (pressing +/- on the remote control).

9. Press the **MULTI JOG** knob (**ENTER** on the remote control) to confirm the total recording time.

This unit returns to the recording pause mode.

FINALIZATION

Finalization is the process that concludes recording, and allows a CD-R disc to be played on a standard CD player or a CD-RW disc to be played on a CD-RW-compatible player.

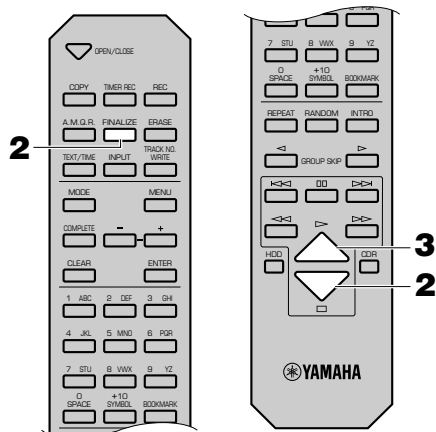
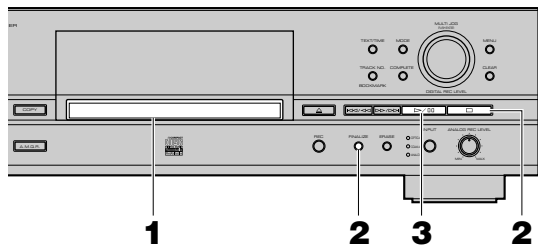

1. Load a recorded CD-R or CD-RW disc without finalization.

2. Press FINALIZE.

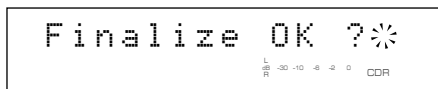

To cancel finalization, press \square .

If you wish to make finalization at slower speed, press and hold **FINALIZE** for approximately 3 seconds.

The following message appears on the display and this unit enters the slow finalization mode.



3. Press \triangleright/\square (\triangleright on the remote control) to start finalization.

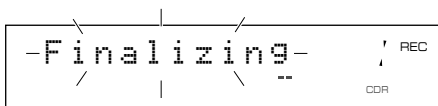

The level meter shows the finalization progress on the display.

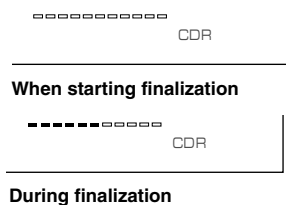

When finalization is completed, the **TOC** indicator lights up and this unit enters the stop mode.

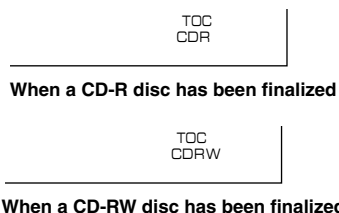

Cautions

- Further recording is not possible onto a finalized CD-R disc. Make sure that all recordings have been completed before finalization.
- Make sure a CD-R or CD-RW disc has no scratches, dust, fingerprints or similar marks before loading. Wipe a CD-R or CD-RW disc if there is any dust on it. See page 4 for handling of a CD-R or CD-RW disc.
- Once the finalization process has started, no other operation is possible until finalization is completed.
- Never turn off the power or disconnect the power cord during finalization.

ERASING A CD-RW DISC

You can erase the data recorded on a CD-RW disc. New recordings can be made in the space created by erasing. The following 4 types of erasing are possible with this unit.

■ Last Track Erase

This operation erases the last track on a disc. "Last Track Erase" cannot be performed if a CD-RW disc has been finalized, or only one track has been recorded on the disc.

1. Load the CD-RW disc to be erased.
2. Press ERASE.

The following message appears on the display.



Go to the next step when erasing only the last track. To erase other tracks as well, select the track number to start erasing from by rotating the **MULTI JOG** knob.

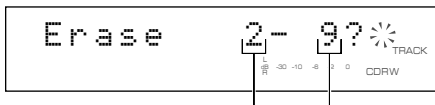

Track to start erasing from Last track

To cancel erasing, press □.

3. Press ▷/00 (▷ on the remote control) to start erasing. "Erasing" flashes on the display, and the level meter shows the erasing progress.
4. This unit enters the stop mode when erasing has been completed.

■ All Track Erase

This operation erases all tracks recorded on a CD-RW disc. TOC will be erased also if a CD-RW disc has been finalized.

1. Load the CD-RW disc to be erased.
2. Press ERASE repeatedly until "Erase ALL ?" appears on the display.

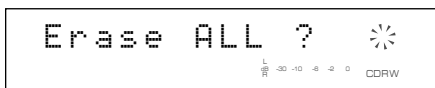

To cancel erasing, press □.

3. Press ▷/00 (▷ on the remote control) to start erasing. "Erasing" flashes on the display, and the level meter shows the erasing progress.
4. This unit enters the stop mode when erasing has been completed.

■ TOC Erase

This operation is only available on a CD-RW disc that has been finalized. After the Table of Contents (TOC) has been erased, the effects of finalization are defeated, and further recording is possible.

1. Load the CD-RW disc that has been finalized.
2. Press ERASE.

"Erase TOC ?" appears on the display.



To cancel erasing, press □.

3. Press ▷/00 (▷ on the remote control) to start erasing. "Erasing" flashes on the display, and the level meter shows the erasing progress.
4. This unit enters the stop mode when erasing has been completed.

Note

- The TOC indicator turns off when "TOC Erase" has been completed.

■ Disc Erase

This operation erases all information recorded on a CD-RW disc.

1. Load the CD-RW disc to be erased.
2. Press and hold ERASE for approximately 2 seconds. "Erase Disc ?" appears on the display.

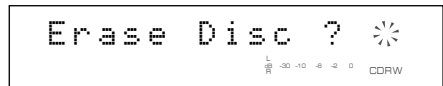

To cancel erasing, press □.

3. Press ▷/00 (▷ on the remote control) to start erasing. "Erasing" flashes on the display, and the level meter shows the erasing progress.
4. This unit enters the stop mode when erasing has been completed.

Cautions

- Never turn off the power of this unit during erasing.
- If "Check Disc" appears on the display during erasing, and erasing stops, there may be dust or damage on the CD-RW disc. Check the CD-RW disc and start the erasing operation again.
- Erasing a disc takes approximately 20 minutes.

DUPLICATION OF A CD

You can quickly duplicate a commercially available CD using this unit.

Caution

- Duplication may not correctly made on a CD-R or CD-RW disc that does not support high speed writing. In this case, copy a CD onto the HDD first, then perform "Digital Move" on a CD-R or CD-RW disc at 2x or 1x speed.

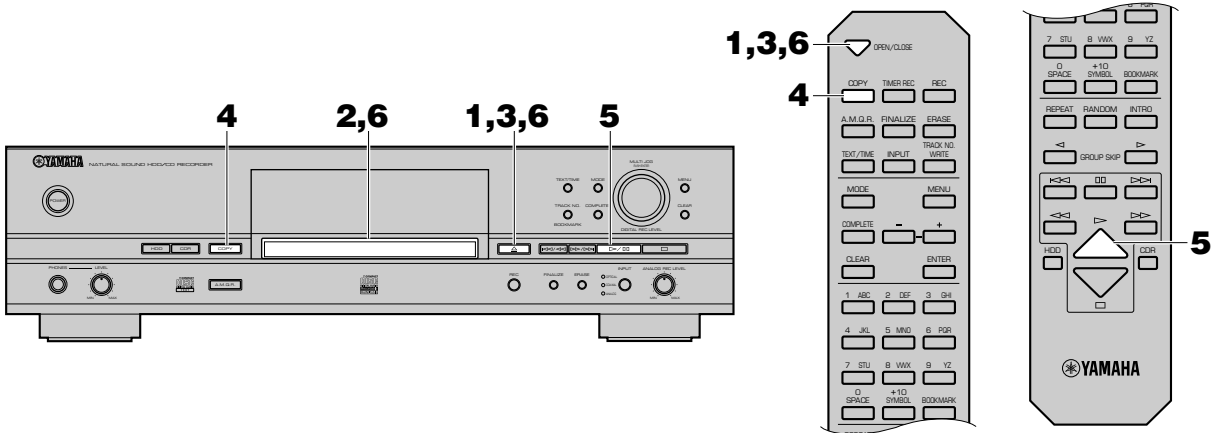

1. Press \triangle (OPEN/CLOSE on the remote control) to open the disc tray.

2. Load the CD to duplicate on the disc tray.

Place the CD correctly aligned in the recessed area of the disc tray with its label side facing up.

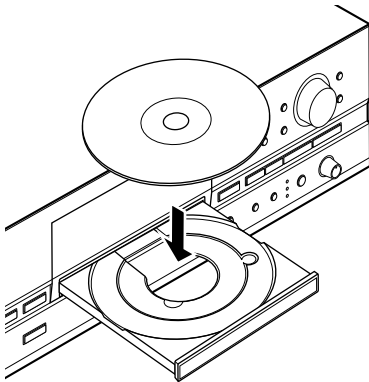

3. Press \triangle (OPEN/CLOSE on the remote control) to close the disc tray.

Note

- The disc tray can be also closed by pressing the front edge of the disc tray gently. If the disc tray is closed in this way, this unit starts playback of the CD. Press \square to stop playback.

This unit starts reading the information (type and capacity of a CD) when a CD is loaded. It takes approximately 10 to 15 seconds. The following message appears on the display during reading.



When reading the information has been completed, the display changes as follows, and this unit becomes ready for operation.

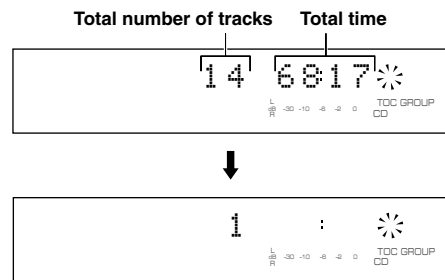

4. Press COPY three times.

The following message appears on the display, and this unit enters the copy standby mode. Duplication has not been started yet at this stage.

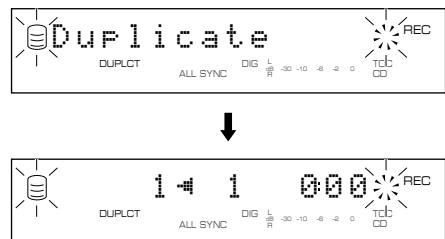

5. Start copying from the CD onto the HDD.

Press ▷/□ (▷ on the remote control) to start copying. The copying conditions are as follows:

- Copy Method: “Digital Copy”
- Copy Level: 0dB
- Copy Speed: “Best Effort”

Cautions

- If copying is canceled by □ being pressed, even the data that has been copied before cancellation does not remain on the HDD.
- If a track is copy protected by the SCMS standard, that track cannot be copied onto the HDD.

When copying from the CD onto the HDD has been completed, the following message appears on the display.



6. Load a new CD-R or CD-RW disc on the disc tray.

Press △ (OPEN/CLOSE on the remote control) to open the disc tray, and place a CD-R or CD-RW disc with its recordable side facing down. Then press △ (OPEN/CLOSE on the remote control) to close the disc tray.

Caution

- New recordings cannot be added to a CD-R or CD-RW disc on which some tracks have been previously recorded.

When the disc tray is closed, this unit starts reading information of the CD-R or CD-RW disc loaded. When reading has been completed, copying from the HDD to a CD-R or CD-RW disc starts automatically.

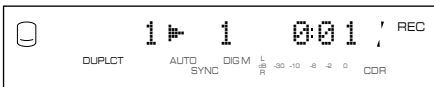

The copying conditions are as follows:

- Copy Method: “Digital Move”
- Copy Level: 0dB
- Copy Speed: “Best Effort”

Note

- OPC may start on the loaded CD-R or CD-RW disc depending on its recording condition after reading has been completed.



When the adjustment has been completed, and the above message turns off on the display, this unit automatically starts copying.

Caution

- If copying is canceled by □ being pressed, only the data that has been recorded on the CD-R or CD-RW disc before cancellation remains on the disc. The original data on the HDD being copied will be deleted.

When copying has been completed, the HDD operation automatically stops, and finalization of the CD-R or CD-RW disc starts.



After finalization has been completed, this unit enters the stop mode.

CD TEXT

If a CD to be duplicated has CD TEXT that can be copied, CD TEXT will be automatically copied at duplication.

High Quality Duplication

You can duplicate a CD with high quality sound with the Audio Master Quality Recording mode.

Cautions

- Audio Master Quality Recording mode can be used only for duplicating on a new CD-R disc.
- Recordable time is 63 minutes for a 74-minute CD-R disc, and 68 minutes for an 79-minute CD-R disc.

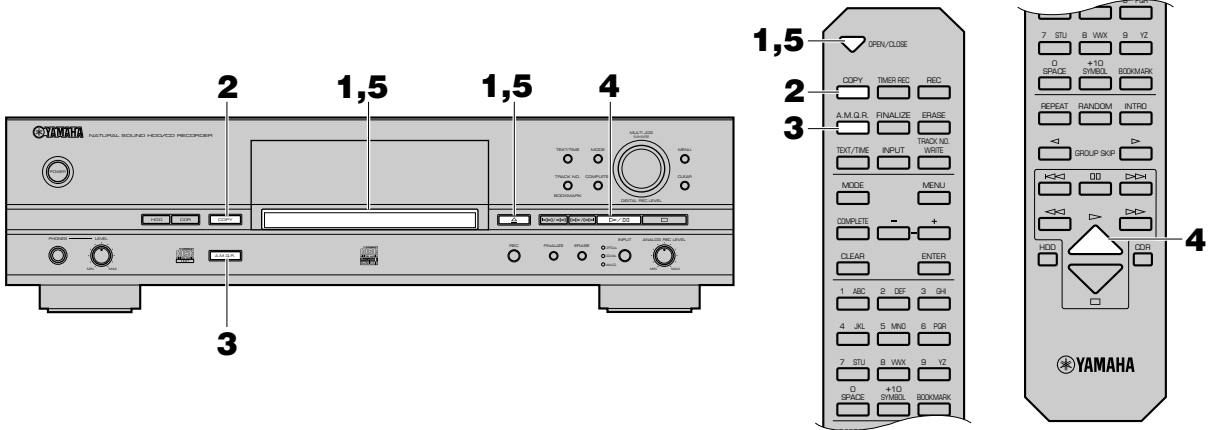

1. Load a CD to be duplicated.

Press \triangle (OPEN/CLOSE on the remote control) to open the disc tray, and place a CD with its label side facing up. Then press \triangle (OPEN/CLOSE on the remote control) to close the disc tray.

2. Press COPY 3 times.

This unit enters the copy standby mode. Copying has not been started yet at this stage.

3. Press A.M.Q.R.

The A.M.Q.R. indicator lights up on the display.



4. Start copying from the CD onto the HDD.

Press \triangleright/\square (\triangleright on the remote control) to start copying. The copying conditions are as follows:

- Copy Method: "Digital Copy"
- Copy Level: 0dB
- Copy Speed: "Best Effort"

Cautions

- If copying is canceled by \square being pressed, even the data that has been copied before cancellation does not remain on the HDD.
- If a track is copy protected by the SCMS standard, that track cannot be copied onto the HDD.

When copying from the CD onto the HDD has been completed, the following message appears on the display.



5. Load a new CD-R disc.

Press \triangle (OPEN/CLOSE on the remote control) to open the disc tray, and place a CD-R disc with its recordable side facing down. Then press \triangle (OPEN/CLOSE on the remote control) to close the disc tray.

Caution

- New recording cannot be added to a CD-R disc on which some tracks have been previously recorded.

When the disc tray is closed, this unit starts reading information of a CD-R disc loaded. When reading has been completed, copying from the HDD to a CD-R will automatically start.

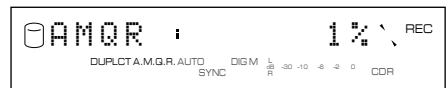

The copying conditions are as follows:

- Copy Method: "Digital Move"
- Copy Level: 0dB
- Copy Speed: 4x speed

Cautions

- When total time of the CD to be duplicated exceeds recordable time on a CD-R disc (63 minutes for a 74-minute CD-R disc and 68 minutes for an 79-minute CD-R disc), the following message appears on the display. In this case, Audio Master Quality Recording mode cannot be used.



- When a CD-R disc other than a 74-minute, 79-minute or 4x writing compatible CD-R disc is loaded, or a CD-RW disc is loaded on this unit, the following message appears on the display. In this case, Audio Master Quality Recording mode cannot be used.



- Once copying starts, no button operation is effective until copying is completed.

When copying has been completed, the operation of the HDD and the CD automatically stops.

PLAYBACK

This unit can play back tracks recorded on the 2 types of recording media; HDD and CD. Press **HDD** to play tracks recorded on the HDD, and press **CDR** to play tracks recorded on a CD (including a CD-R and a CD-RW disc).

Playing a CD

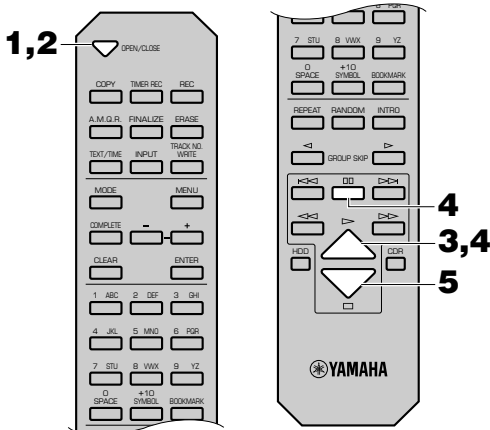
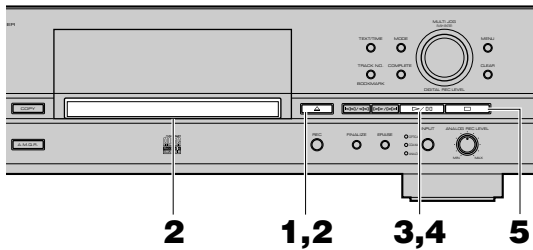

1. Press \triangle (OPEN/CLOSE on the remote control) to open the disc tray.
2. Load the CD to be played on the disc tray and close the disc tray by pressing \triangle (OPEN/CLOSE on the remote control).
This unit starts reading the disc information. "Reading" flashes on the display during reading.
3. Start playback.
When \triangleright/\square (\triangleright on the remote control) is pressed, this unit starts playback from the beginning of the first track.
4. Press \triangleright/\square (\square on the remote control) to stop playback temporarily.
Press \triangleright/\square (\triangleright or \square on the remote control) to resume playback.
5. Press \square to stop playback.

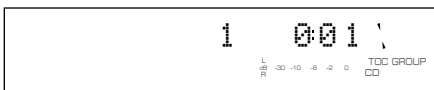

Playing Tracks on the HDD

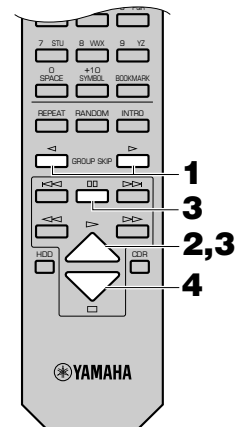
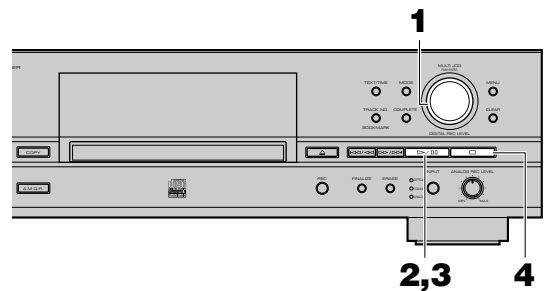

1. Make sure that the GROUP indicator lights up, then rotate the MULTI JOG knob (press GROUP SKIP \triangleleft or GROUP SKIP \triangleright on the remote control) to select a group (disc, album, or bookmark) to be played.
2. Start playback.
When \triangleright/\square (\triangleright on the remote control) is pressed, this unit starts playback from the beginning of the first track of the selected group.
3. Press \triangleright/\square (\square on the remote control) to stop playback temporarily.
Press \triangleright/\square (\triangleright or \square on the remote control) to resume playback.
4. Press \square to stop playback.

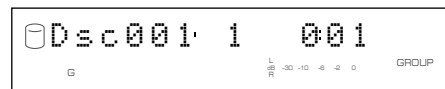

IMPORTANT

- Never turn off the power of this unit during the playback. The data on the HDD may be damaged.
- During the playback, make sure that this unit is not subjected to shock or vibration as the HDD may be damaged.

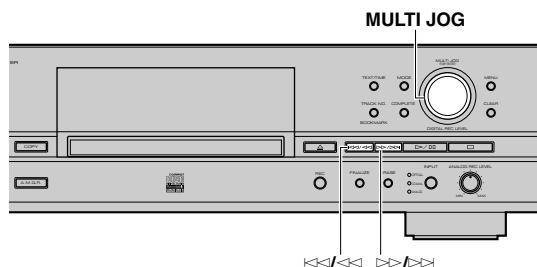

Finding the Desired Passage (Search)

■ To go forward rapidly

Press and hold $\triangleright\triangleright/\triangleright\triangleright$ ($\triangleright\triangleright$ on the remote control) during playback.
When the button is released, normal playback resumes.

■ To go backward rapidly

Press and hold $\triangleleft\triangleleft/\triangleleft\triangleleft$ ($\triangleleft\triangleleft$ on the remote control) during playback.
When the button is released, normal playback resumes.

Notes

- Search is possible in the pause mode. No sound can be heard when searching is performed during the pause mode.
- Neither search nor pause is possible at the interval added by “Tr. Interval” on the ALBUM EDITING menu (see page 38).

Resume Play function

If you press \triangleright/\square (\triangleright on the remote control) after \square has been pressed to stop playback, this unit starts playback from the beginning of the track that has been stopped. This function is called “Resume Play”. To cancel the “Resume Play” function, press \square to stop playback first and then press \square again. After the cancellation, this unit starts playback from the beginning of the first track recorded on a disc (or an album) or a CD.

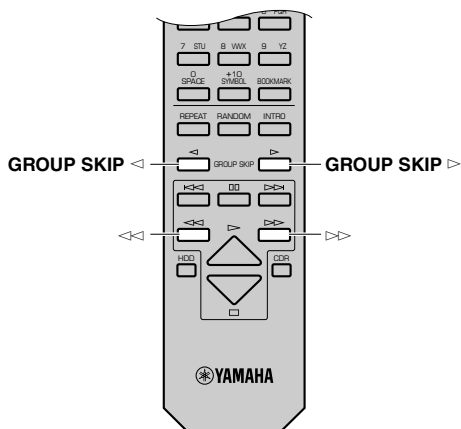

Finding the Desired Group (Group Skip)

You can select the group (disc, album, or bookmark) recorded on the HDD.

■ To select the desired group with the MULTI JOG knob

Press the **MULTI JOG** knob to turn on the **GROUP** indicator on the display.

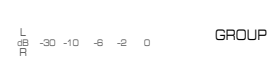

Rotate the **MULTI JOG** knob clockwise to advance to the next group and the following groups or counterclockwise to return to the previous group and other previous groups.

■ To advance to the next group

Press **GROUP SKIP** \triangleright on the remote control.
Press **GROUP SKIP** \triangleright repeatedly to advance to other groups.

■ To return to the previous group

Press **GROUP SKIP** \triangleleft on the remote control.
Press **GROUP SKIP** \triangleleft repeatedly to return to other previous groups.

Notes

- Group skip is possible in the play, pause and stop modes.
- Playback starts from the beginning of the first track of the selected group.

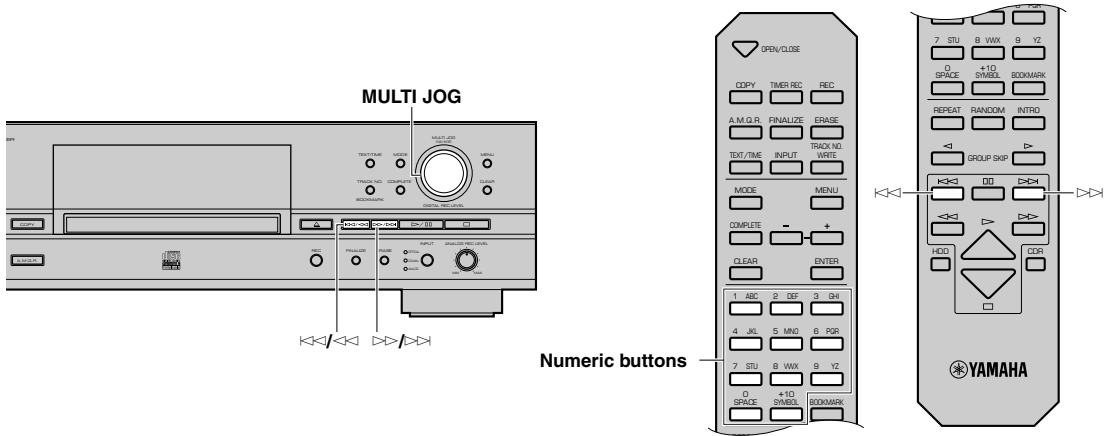

Finding the Desired Track (Track Skip)

■ To select the desired track number with the MULTI JOG knob

Press the **MULTI JOG** knob to turn on the **TRACK** indicator on the display.

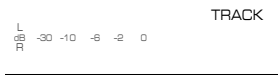

Rotate the **MULTI JOG** knob clockwise to advance to the next track and the following tracks or counterclockwise to return to the previous track and other previous tracks.

■ To advance to the next track

Press $\triangleright\triangleright/\triangleright\triangleright$ ($\triangleright\triangleright$ on the remote control). Press $\triangleright\triangleright/\triangleright\triangleright$ ($\triangleright\triangleright$ on the remote control) repeatedly to skip to other tracks.

■ To return to the beginning of the track being played

Press $\triangleleft\triangleleft/\triangleleft\triangleleft$ ($\triangleleft\triangleleft$ on the remote control) once during playback.

■ To return to the previous track

Press $\triangleleft\triangleleft/\triangleleft\triangleleft$ ($\triangleleft\triangleleft$ on the remote control) twice during playback. Press $\triangleleft\triangleleft/\triangleleft\triangleleft$ ($\triangleleft\triangleleft$ on the remote control) repeatedly to return to other previous tracks.

■ To play the desired track

Select the desired track by using the numeric buttons on the remote control. The selected track number appears on the display.

Example: To select track 25

Press **+10** twice, and then immediately press **5** once.

Note

- If a number higher than the last track number recorded on a disc (or an album) or a CD is entered by using the remote control, this unit plays the last track.

Note

- Track skip is possible in the play, pause and stop modes.

Selecting Tracks Using On-Screen-Display (OSD)

You can display a list of groups and tracks to be played by connecting this unit to a monitor. If you display the list on a screen, it is much easier to see than on the display.

Note

- When "VIDEO Output" on the system utility is set to OFF, no OSD signals will be output. Set it to ON to have an on-screen-display (see page 87).

■ Select a group

1. Press the MULTI JOG knob to turn on the GROUP indicator.

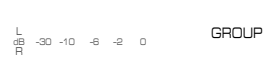

The following list will be displayed on a monitor.

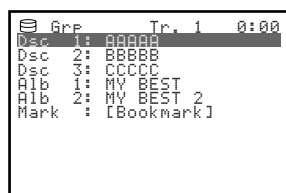

2. Rotate the MULTI JOG knob (press +/- on the remote control) to select a group.

The selected group indicator will be in reverse video.

■ Select a track

1. Press the MULTI JOG knob to turn on the TRACK indicator.

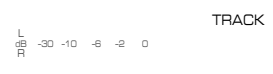

The following list will be displayed on a monitor.

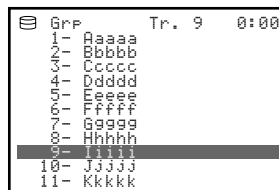

2. Rotate the MULTI JOG knob (press +/- on the remote control) to select a group.

The selected group indicator will be in reverse video.

Note

- The track with a bookmark has *(asterisk) added in front of the track number.

Listening with Headphones

Connect your headphones to the PHONES jack and adjust the volume with the LEVEL control.

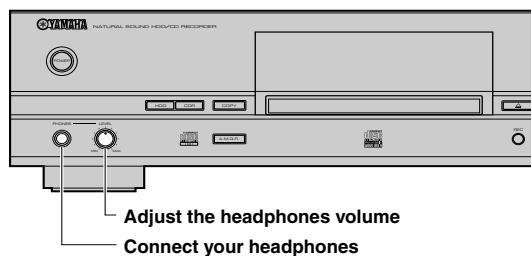

Caution

- If the power of other components such as an amplifier connected to this unit is not turned on, the sound of this unit may be distorted. If this occurs, use the headphones with the other component's power turned on.

VARIOUS PLAYBACK

This unit provides various playback methods according to the setting. The following steps describe the setting procedure for each setting.

Notes

- The setting of play style, random play, repeat play, and intro play can be set during the playback.
- The setting of play style, random play, and full repeat play is memorized even after the power of this unit has been turned off.

Finding the Desired Passage by Time (Time Search)

You can search the desired part by setting the time.

1. Press **HDD** or **CDR** to select a drive to operate.
2. Press **MODE** to enter the playback mode setting.
“Time Search” appears on the display.

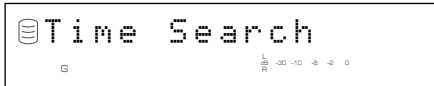

3. Press the **MULTI JOG** knob (**ENTER** on the remote control).

The following message appears on the display.



Time to be searched

4. Rotate the **MULTI JOG** knob (press +/- on the remote control) to set the time to be searched.

If you stop rotating the **MULTI JOG** knob, this unit starts searching the set time and starts playback from the set time.

Notes

- You can start searching the set time by pressing the **MULTI JOG** knob (**ENTER** on the remote control) also.
- You can skip to other tracks by pressing **◀◀/◀◀** or **▶▶/▶▶** (**◀◀** or **▶▶** on the remote control). When the track is skipped to another track, the set time will be reset to “0:00”.
- You can skip to other groups by pressing **GROUP SKIP ◀** or **GROUP SKIP ▶** on the remote control. When the group is skipped to another group, the set time will be reset to “0:00”.
- You cannot search by pressing **◀◀/◀◀** or **▶▶/▶▶** (**◀◀** or **▶▶** on the remote control) during the time search mode.

5. Press **MODE** to return to the normal playback.

Note

- You cannot search by time during the random play or the intro play.

Setting the Play Style

Only when playing sources recorded on the HDD, you can set the play style. The play style setting changes the range of playback.

1. Press **HDD** to select the HDD.
2. Press **MODE** to display the playback mode setting.
3. Rotate the **MULTI JOG** knob (press +/- on the remote control) to display “Play Style”.

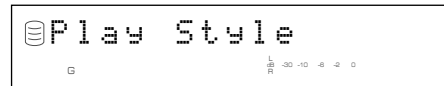

4. Press the **MULTI JOG** knob (**ENTER** on the remote control) to start the play style setting.
5. Rotate the **MULTI JOG** knob (press +/- on the remote control) to display “Style All” or “Style Group”.

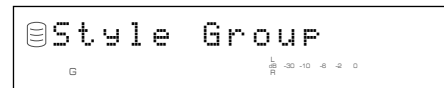
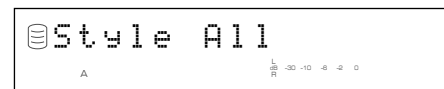

6. Press the **MULTI JOG** knob (**ENTER** on the remote control) to confirm the selection.

■ When “Style All” is confirmed

The **A** indicator lights on the display.

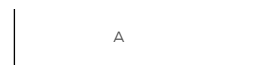

Random play, full repeat play, or intro play can be set for one of the group categories (disc, album, and bookmark) recorded on the HDD.

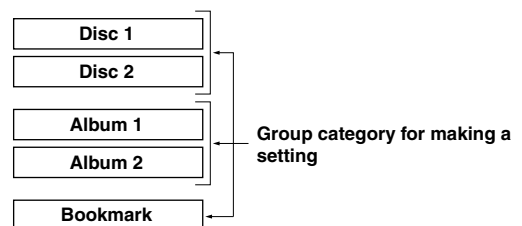

- When random play is set, all tracks that belong to the selected group category are played in a random sequence.
- When full repeat play is set, all tracks that belong to the selected group category are repeatedly played.
- When intro play is set, the beginnings of all tracks that belong to the selected group category are played one after another.

For example, if full repeat play is set during the playback of disc 1, all tracks recorded to discs 1 and 2 are repeatedly played.

Notes

- If “Style All” is set and the title is shown on the display, the sound may be missing when this unit switches from one disc to another. To avoid this problem, switch the display to from the indication of time by pressing **TEXT/TIME** (see page 11).
- Select “Style All” when sequentially playing the sources recorded for long hours extending several discs.

■ When “Style Group” is confirmed

The **G** indicator lights on the display.



Random play, full repeat play, or intro play can be set for one of the groups (disc, album, and bookmark) recorded on the HDD.

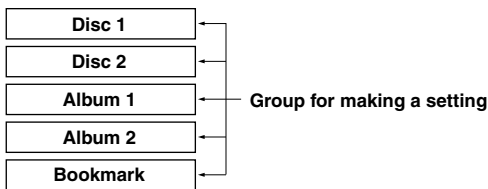

- When random play is set, all tracks that belong to the selected group are played in a random sequence.
- When full repeat play is set, all tracks that belong to the selected group are repeatedly played.
- When intro play is set, the beginnings of all tracks that belong to the selected group are played one after another.

For example, if full repeat play is set during the playback of disc 1, all tracks recorded to disc 1 are repeatedly played.

Single Repeat Play

You can listen to a single desired track or to a track being played repeatedly.

■ To set single repeat play

1. Press **HDD** or **CDR** to select the drive to be used.
2. Press **MODE** to start the playback mode setting.
3. Rotate the **MULTI JOG** knob (press **+/-** on the remote control) to display “Repeat”.



4. Press the **MULTI JOG** knob (**ENTER** on the remote control) to start setting single repeat play.
5. Rotate the **MULTI JOG** knob (press **+/-** on the remote control) to display “Repeat Single”.

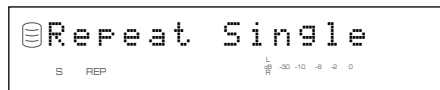

6. Press the **MULTI JOG** knob (**ENTER** on the remote control) to confirm the selection.

The **S REP** indicator lights on the display.



Notes

- Single repeat play can be easily set by pressing **REPEAT** on the remote control once.
- The track being played is repeatedly played even during playback of an album or random play.

■ To cancel the single repeat play setting

Select and confirm “Repeat Off” in step 5 for “To set single repeat play” or press **REPEAT** on the remote control repeatedly until the **S REP** indicator turns off on the display.

Full Repeat Play

You can repeatedly listen to all tracks recorded in a group (or a CD) or group category.

■ To set full repeat play

1. Press **HDD** or **CDR** to select the drive to be used.
2. Press **MODE** to start the playback mode setting.
3. Rotate the **MULTI JOG** knob (press +/- on the remote control) to display "Repeat".



4. Press the **MULTI JOG** knob (**ENTER** on the remote control) to start setting full repeat play.
5. Rotate the **MULTI JOG** knob (press +/- on the remote control) to display "Repeat Full".



6. Press the **MULTI JOG** knob (**ENTER** on the remote control) to confirm the selection. The **REP** indicator lights on the display.



Notes

- Full repeat play can be easily set by pressing **REPEAT** on the remote control twice.
- The tracks are repeatedly played in the same random order if played in the random play mode.

■ To cancel the full repeat play setting

Select and confirm "Repeat Off" in step 5 for "To set full repeat play" or press **REPEAT** on the remote control repeatedly until the **REP** indicator turns off on the display.

Random Play

You can listen to all tracks recorded in a group on the HDD or on a CD in a random sequence.

■ To set random play

1. Press **HDD** or **CDR** to select the drive to be used.
2. Press **MODE** to start the playback mode setting.
3. Rotate the **MULTI JOG** knob (press +/- on the remote control) to display "Random".



4. Press the **MULTI JOG** knob (**ENTER** on the remote control) to start setting random play.
5. Rotate the **MULTI JOG** knob (press +/- on the remote control) to display "Random On".

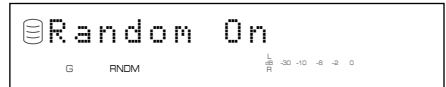

6. Press the **MULTI JOG** knob (**ENTER** on the remote control) to confirm the selection. The **RNDM** indicator lights on the display.



Notes

- Random play can be easily set by pressing **RANDOM** on the remote control.
- If random play is set during playback, the new setting applies to the next track.

■ To start random play

When random play is set, press \triangleright/\square (\triangleright on the remote control) to start random play.

■ To stop random play

Press \square .

■ To cancel the random play setting

Select and confirm "Random Off" in step 5 for "To set random play" or press **RANDOM** on the remote control. The **RNDM** indicator turns off on the display.

Intro Play

You can listen to the beginnings of the tracks for a set amount of time one after another.

■ To set intro play

1. Press **HDD** or **CDR** to select the drive to be used.
2. Press **MODE** to start the playback mode setting.
3. Rotate the **MULTI JOG** knob (press **+/-** on the remote control) to display “Intros Scan”.

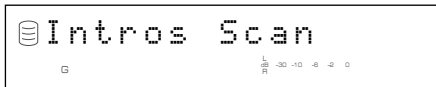

4. Press the **MULTI JOG** knob (**ENTER** on the remote control) to start setting intro play.
5. Rotate the **MULTI JOG** knob (press **+/-** on the remote control) to set the amount of time to play the beginning of each track.

The playback time can be set in the 1 to 10 seconds range by 1 second steps and in the 10 seconds to 60 seconds range by 5 seconds steps.



■ To start intro play

After the playback time for intro play has been set in step 5 for “To set intro play”, press the **MULTI JOG** knob (**ENTER** on the remote control) to confirm the setting or press **>/00** (**>** on the remote control) to start intro play.

Notes

- Intro play can be easily started by pressing **INTRO** on the remote control.
- The beginning of the selected track is repeatedly played if single repeat is set.
- When “Style Group” is set with the full repeat play mode, the beginnings of all tracks recorded in the selected group are repeatedly played.
- When “Style All” is set with the full repeat play mode, the beginnings of all tracks recorded in the selected group category are repeatedly played.
- The beginnings of randomly selected tracks are played if random play is set.

■ To stop intro play

Press **□**.

■ To cancel the intro play setting

Press **INTRO** on the remote control.

Bookmark Play

You can easily listen to a group of desired tracks by selecting a list of tracks with bookmarks.

■ To place a bookmark

Press **TRACK NO./BOOKMARK** (**BOOKMARK** on the remote control) during playback of the desired track. Tracks are listed and stored in order that the bookmarks have been placed. See “**BOOKMARK**” on page 59.

■ Start playback of the track with a bookmark

1. Press **HDD** or **CDR** to select a drive to operate.
2. Press the **MULTI JOG** knob (**ENTER** on the remote control) to turn on the **GROUP** indicator on the display.
3. Rotate the **MULTI JOG** knob (press **+/-** on the remote control) to select “Mark”.

When selecting “Mark” on a CD

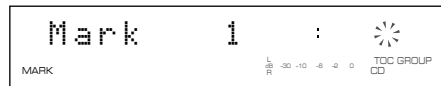

When selecting “Mark” on the HDD

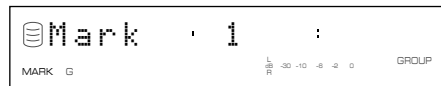

4. Start playback.

Playback starts from the beginning of the first track when **>/00** (**>** on the remote control) is pressed.

Note

- Tracks are played in the order that bookmarks have been placed.

5. To stop playback temporarily, press **>/00** (**00** on the remote control).

To resume playback, press **>/00** (**>** or **00** on the remote control).

DAC (DIGITAL/ANALOG CONVERTER) MODE

This unit has a DAC mode function. You can switch the input signals, as an input selector, to output from both the analog and digital jacks to the amplifier connected to this unit.

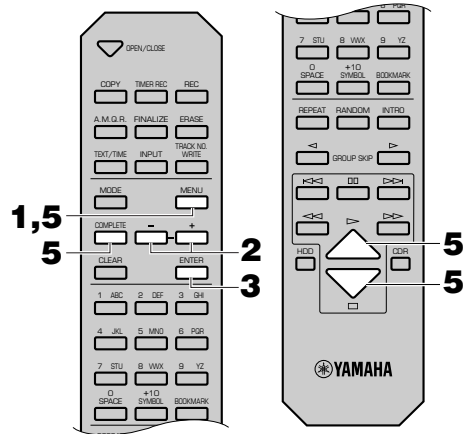
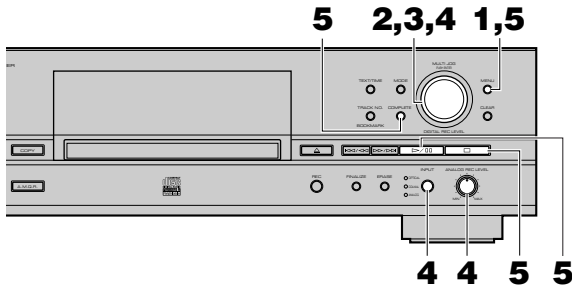

1. Press MENU while this unit is in the stop mode.

The display changes for the menu item selection.

2. Select "DAC Mode" by rotating the MULTI JOG knob (pressing +/- on the remote control).



3. Press the MULTI JOG knob (ENTER on the remote control) to enter the DAC mode.

4. The input source selected by INPUT is output both from the ANALOG LINE OUT (PLAY) jacks and from the DIGITAL OUT (OPTICAL/COAXIAL) jacks.

- When **OPTICAL** or **COAXIAL** is selected, the **MULTI JOG** knob functions as a volume control.
- When **ANALOG** is selected, the **ANALOG REC LEVEL** control functions as a volume control.

5. Any of the following operation cancel the DAC mode and start normal operation.

- Press **▷/□** (**▷** on the remote control) to play the drive that had been selected before entering the DAC mode.
- Press **□** to set this unit in the stop mode.
- Press **COMPLETE** to set this unit in the stop mode.
- Press **MENU** to return to the menu item selection.

■ To check the HDD utility (HDD Info.)

You can check the HDD utility (capacity, usage, and available space) of this unit.

1. Press **MENU** while this unit is in the stop mode.
The display changes for the menu item selection.
2. Select “HDD Utility” by rotating the **MULTI JOG** knob (pressing +/- on the remote control).



3. Press the **MULTI JOG** knob (**ENTER** on the remote control) to display “HDD Info.”.



4. Press the **MULTI JOG** knob (**ENTER** on the remote control) again to display the capacity of the HDD. Each time the **MULTI JOG** knob is rotated (+/- on the remote control is pressed), the display changes as follows. Indications are made by time.

Capacity (total time)



Usage (total used time)



Available space (recordable time)

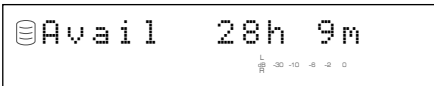

Note

- The times displayed are rough estimates.

5. Press **□** to exit.
The display changes to the one when this unit was in the stop mode.

■ To format the HDD (HDD Format)

You can format the HDD in this unit.

Cautions

- After the HDD has been formatted, all data about the recorded tracks and settings will be erased from the HDD.
- After all data on the HDD have been initialized, the undo function cannot be applied to any editing operations before formatting.

1. Press **MENU** while this unit is in the stop mode.
The display changes for the menu item selection.
2. Select “HDD Utility” by rotating the **MULTI JOG** knob (pressing +/- on the remote control).
3. Press the **MULTI JOG** knob (**ENTER** on the remote control).
The display changes for the HDD utility item selection.
4. Select “HDD Format” by rotating the **MULTI JOG** knob (pressing +/- on the remote control).

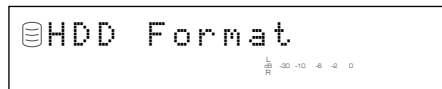

5. “Initialize ?” appears on the display when the **MULTI JOG** knob (**ENTER** on the remote control) is pressed.



6. “Format Really” appears on the display to make a confirmation when **▷/□** (▷ on the remote control) is pressed.

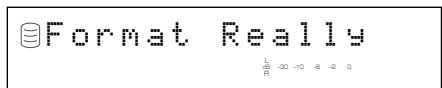

If you wish to format the HDD, press **INPUT**. If not, press **□**.

7. “Format OK” appears in the display when **INPUT** is pressed. Then the display returns to the one when the power of this unit was turned on.

Caution

- The method explained above cannot be used to format an HDD newly installed. To format an HDD newly installed, see the attached instruction.

■ To check the firmware version (Firm. Version)

Software that is called “firmware” is built into this unit. This firmware controls the operation. The following steps describe the firmware version check procedures.

1. Press **MENU** while this unit is in the stop mode.
The display changes for the menu item selection.
2. Select “Sys. Utility” by rotating the **MULTI JOG** knob (pressing +/- on the remote control).

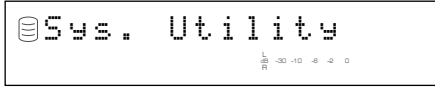

3. Press the **MULTI JOG** knob (**ENTER** on the remote control) to display “Firm. Version”.

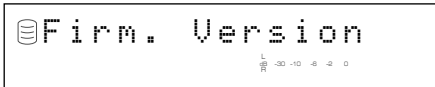

4. Press the **MULTI JOG** knob (**ENTER** on the remote control) again to display the version of the firmware.



The display switches in the order of the system firmware version → the CDR drive firmware version → type of HDD as the **MULTI JOG** knob is rotated (+/- on the remote control is pressed).

System firmware version

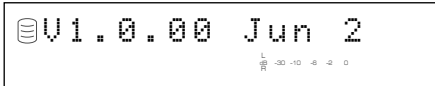

CDR drive firmware version

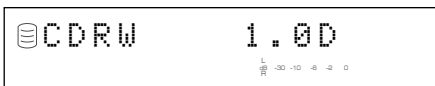

Type of HDD



5. Press **□** to exit.

The display changes to the one when this unit was in the stop mode.

■ To initialize the setting for each item (Initialize)

You can initialize the settings that have been changed. The OPC data stored in this unit is also initialized.

1. Press **MENU** while this unit is in the stop mode.
The display changes for the menu item selection.
2. Select “Sys. Utility” by rotating the **MULTI JOG** knob (pressing +/- on the remote control).
3. Press the **MULTI JOG** knob (**ENTER** on the remote control).
The display changes for the system utility item selection.
4. Select “Initialize” by rotating the **MULTI JOG** knob (pressing +/- on the remote control).

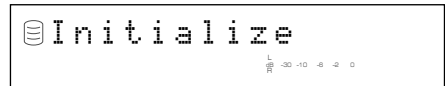

5. “Initialize ?” appears on the display if the **MULTI JOG** knob (**ENTER** on the remote control) is pressed.



6. Press **COMPLETE**.

The display returns to the one when the power of this unit is turned on.

■ To change the display brightness (Dimmer Setup)

You can change the brightness of the display.

1. Press **MENU** while this unit is in the stop mode.
The display changes for the menu item selection.
2. Select “Sys. Utility” by rotating the **MULTI JOG** knob (pressing +/- on the remote control).
3. Press the **MULTI JOG** knob (**ENTER** on the remote control).
The display changes for the system utility item selection.
4. Select “Dimmer Setup” by rotating the **MULTI JOG** knob (pressing +/- on the remote control).

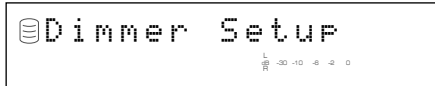

5. The current setting is indicated on the display if the **MULTI JOG** knob (**ENTER** on the remote control) is pressed.



The selection and the brightness change in 3 levels as the **MULTI JOG** knob is rotated (+/- on the remote control is pressed).



Note

- Initial setting is “Dimmer Bright”.

6. Press the **MULTI JOG** knob (**ENTER** on the remote control) or **COMPLETE**.

The display brightness has been set.

7. Press **□** to exit.

The display changes to the one when this unit was in the stop mode.

■ To set the video output (VIDEO Output)

You can switch the on-screen display output through the **VIDEO OUT** jacks on and off.

1. Press **MENU** while this unit is in the stop mode.
The display changes for the menu item selection.
2. Select “Sys. Utility” by rotating the **MULTI JOG** knob (pressing +/- on the remote control).
3. Press the **MULTI JOG** knob (**ENTER** on the remote control).
The display changes for the system utility item selection.
4. Select “VIDEO Output” by rotating the **MULTI JOG** knob (pressing +/- on the remote control).

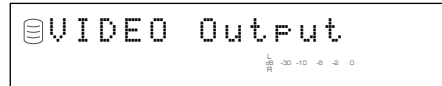

5. The current setting is indicated on the display if the **MULTI JOG** knob (**ENTER** on the remote control) is pressed.

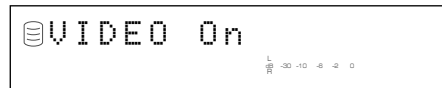

Switch “VIDEO On” and “VIDEO Off” by rotating the **MULTI JOG** knob (pressing +/- on the remote control).

Note

- Initial setting is “VIDEO On”.

6. Press the **MULTI JOG** knob (**ENTER** on the remote control) or **COMPLETE**.

The on-screen display output is set to on or off.

Note

- If “VIDEO Off” is selected, the video circuit inside this unit is also turned off. You can enjoy the playback or recording in higher quality sound.

7. Press **□** to exit.

The display changes to the one when this unit was in the stop mode.

■ To set auto play (Auto Play)

You can set the auto play function which automatically starts playback when the power of this unit is turned on.

1. Press MENU while this unit is in the stop mode.

The display changes for the menu item selection.

2. Select “Sys. Utility” by rotating the MULTI JOG knob (pressing +/- on the remote control).

3. Press the MULTI JOG knob (ENTER on the remote control).

The display changes for the system utility item selection.

4. Select “Auto Play” by rotating the MULTI JOG knob (pressing +/- on the remote control).



5. The current setting is indicated on the display if the MULTI JOG knob (ENTER on the remote control) is pressed.



Switch “Auto Play On” and “Auto Play Off” by rotating the MULTI JOG knob (pressing +/- on the remote control).

Note

- Initial setting is “Auto Play Off”.

6. Press the MULTI JOG knob (ENTER on the remote control) or COMPLETE.

The auto play function is set to on or off.

If the auto play function is set to on, the setting will be applied when the power of this unit is turned on the next time.

- This unit plays data on the drive that had been last selected when the power of this unit was last turned off.
- This unit plays in the playback mode (such as random play) that had been last set when the power of this unit was last turned off.

Note

- The setting for the timer recording takes precedence over the setting for the auto play function. If the timer recording is set, this unit starts recording when the power of this unit is turned on the next time even when “Auto Play On” is selected. See page 22 for the timer recording.

■ To update the firmware version (Firm. Update)

This menu is prepared for the expansion of the functions in the future.

ON-SCREEN DISPLAY (OSD)

You can display the list of groups or tracks to be played, copying/recording settings and the list of the setting items on the monitor by connecting the monitor to this unit.

■ List of groups or tracks

The numbers and titles of groups, or the numbers and titles of tracks are displayed. Press the **MULTI JOG** knob to switch the list displayed.

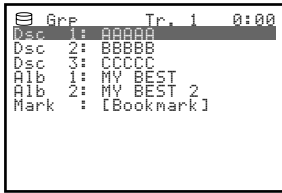

■ Display during copying

The settings for copying are displayed.



Example: when copying from a CD to the HDD

■ Display during recording

The setting for recording are displayed.

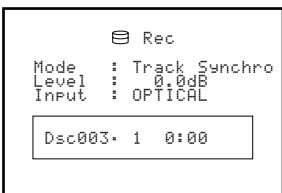

Example: when recording to the HDD

■ List of setting items

The names of items to be set are displayed.

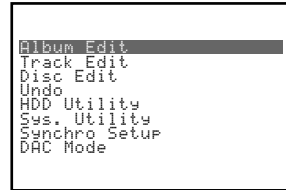

Example: when setting the menu

■ Display during titling

This is displayed while the title is being assigned to albums, tracks, or discs.

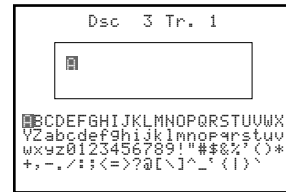

Example: when titling the track

DISPLAY MESSAGES

Can't Copy

This message is displayed for approximately 3 seconds when digital recording or copying is not possible according to the SCMS standard.

See "Rules of Digital Recording" on page 5.

Can't Edit

This message is displayed when a prohibited editing operation has been attempted.

Can't Tr.Lev.

The album with its tracks' level adjusted is to be copied to a CD-R disc in the Audio Master Quality Recording mode.

Can't use HDD

The loaded HDD has been formatted by other CDR-HD1300s. Reformat by the CDR-HD1300 on which you plan to use that HDD, following the instruction on page 85.

Change Discs!

This message informs that a CD needs to be changed to a disc to be used for duplicating when copying from a CD onto the HDD has been completed.

Check Disc

This unit fails to read the CD because the CD has been loaded on the disc tray upside down or the CD has remarkable scratch on it, or some kind of error has been occurred during operation. Check the disc, and exchange the CD if necessary.

Data Track

This message is displayed when the data track is being played.

Disc Full

This message is displayed when recording to a CD-R or CD-RW disc cannot be performed any further because the recording has been made up to the total recordable time.

Disc No.Full

When the number of discs recorded on the HDD has reached its maximum of 999 discs, this message is displayed if more discs have been attempted to be added.

Drive Check

Some kind of error has been occurred in the HDD or the CDR drive. Contact the nearest authorized YAMAHA dealer or service center. Or HDD is not set to "slave" precisely. Refer to the attached instruction and set the HDD to "slave".

Erasing

Erasing a CD-RW disc is being performed. The erasing progress is indicated by the level meter.

Finalize OK?

This message confirms starting the finalization of a CD-R or CD-RW disc. If you wish to finalize, press \triangleright/\square (\triangleright on the remote control).

Finalizing

Finalization is being performed. The finalization progress is indicated by the level meter.

Format Really

This message confirms starting the format of the HDD after "Initialize ?" appears.

HDD Full

This message is displayed when recording to the HDD cannot be performed any further because the recording has been made up to the total recordable time.

Initialize ?

This message confirms starting the format of the HDD, or the initialization of each item.

Invalid Mode

The recording mode that cannot be selected during the timer recording setting has been selected.

New Disc

The disc in the disc tray is either a new CD-R or CD-RW disc, or a CD-RW disc that has been erased by using a Disc Erase or All Erase.

No Data

There are no tracks (data) recorded on the HDD.

No Disc

There are no CDs on the disc tray.

No Enough Spc

There is not enough space for copying, or the track number exceeds the maximum number when copying.

No Input

There are no input signals when attempting the recording from the external components digitally.

No Previous

When making "Tr. Interval" on the ALBUM EDITING menu or "Track Adjust" on the TRACK EDITING menu, there is no track before the track to be edited.

No Source

There is no source recorded on the HDD or CDs when copying.

Not Audio

A non-audio CD-R or CD-RW disc, such as a CD-R or CD-RW disc for PCs, has been loaded in the disc tray, and recording has been attempted on that CD-R or CD-RW disc.

No Undo data

Undo is not possible.

OPC Adjust

This message is displayed while OPC (Optimum Power Calibration) optimized the laser power to the reflectivity of the disc. Approximately 15 seconds may be required to complete this automatic adjustment. However, this time length may change according to the type of the disc that has been loaded.

Pack Before !

This message is displayed when the editing operation cannot be done unless "Pack" is performed.

Reading

This unit reads the format of the CD, CD-R, or CD-RW disc loaded on the disc tray. Approximately 15 seconds may be required to complete this automatic adjustment. However, this time length may change according to the type of the CD, CD-R, or CD-RW disc that has been loaded.

Slow Final OK?

This message confirms starting the slow finalization of a CD-R or CD-RW disc. If you wish to finalize, press \triangleright / \square (\triangleright on the remote control).

Standby

This message is displayed for several seconds after **REC** has been pressed to record on a CD-R or CD-RW disc.

TEXT Save?

This message is displayed when the disc tray has been attempted to be opened without performing finalization after copying the data including the titles (disc title, track title, and album title) to a CD-R or CD-RW disc.

Timer Standby

This message is displayed after the timer recording setting has been completed, or displayed for approximate 5 seconds before the timer recording starts.

Track No.Full

One disc can contain up to 99 tracks. Recording is attempted on the disc that has reached the maximum number.

Unavailable

The CD-R disc whose recordable time is other than 74 minutes or 79 minutes or the CD-R disc which does not support 4x writing, or the CD-RW disc has been loaded when copying in the Audio Master Quality Recording mode.

Unrecordable

In recording or copying onto a CD-R or CD-RW disc, the disc cannot be used for recording or copying. Or in recording or copying onto the HDD, no space is available.

Wait

This message flashes while this unit is writing information to the PMA (program Memory Area) after \square is pressed in recording onto a CD-R or CD-RW disc, or flashes while processing the data on the HDD or detecting the loaded HDD when this unit is turned on.

TROUBLESHOOTING

If this unit fails to operate normally, check the following points to determine whether the fault can be corrected by the simple measures suggested. If they cannot be corrected, or if the fault is not listed in the SYMPTOM column, disconnect the power cord and contact your authorized YAMAHA dealer or service center for assistance.

| SYMPTOM | CAUSE | REMEDY |
|--|--|--|
| This unit does not turn on when POWER is pressed. | The power cable is not completely connected. | Securely connect the power cable. |
| Playback does not begin with the CD loaded. | There is moisture on the laser pick-up. | Turn the power of this unit and wait 20 to 30 minutes before trying to play. |
| | The CD has been loaded upside down. | Reload the CD with the label side facing up. |
| | The CD is dirty. | Clean the CD. |
| Playback is delayed, or begins at the wrong place. | The CD may be scratched or damaged. | Check the CD carefully. Replace it if necessary. |
| Recording/copying is not possible. | The CD-R or CD-RW disc has been finalized. | Load a recordable CD that has not been finalized yet. |
| | The CD-R or CD-RW disc that has completed recording is loaded. | Load a recordable CD. |
| | INPUT is not correctly set. | Set INPUT to the correct position according to the input signal. |
| | Further digital recording or copying has been attempted from the digitally copied sources. | Switch to ANALOG to make a recording. |
| | There is not enough available space left or 99 tracks have already been recorded on the disc. | Load a recordable disc (for a CD-R or CD-RW disc). Select the other discs (for the HDD). |
| | There is no available space on the HDD. | Erase the space not being used to create available space on the HDD for further recording. |
| | If the power cable was unplugged or there was a power outage during recording, the recorded material may be lost. | If the recording of a CD-RW disc is interrupted, try recording again from the beginning. When the recording of a CD-R disc is interrupted, start recording over again with a disc that can be recorded on. |
| | The CD-R or CD-RW disc is dirty or damaged. | Clean or replace the CD-R or CD-RW disc. |
| Some vibration and rotation noise are created during the copying. | The HDD is not installed properly. | Install the HDD properly following the attached instruction. |
| | This unit copies by rotating the CD, CD-R or CD-RW disc at high speed. | Lower the copying speed to decrease vibration and rotation noise. |
| Continuous recording cannot be made on a disc on the HDD beyond 100 minutes. | The maximum recordable time for a disc on the HDD is 99 minutes 59 seconds. | Regardless of the recording mode, the recording will be performed continuously to the next available disc after the recording has been performed to one disc for its maximum length. |
| The beginning of the track is missing during the playback when this unit is connected digitally to an amplifier. | The tracks that have different emphases have been played. | Connect to the amplifier using the ANALOG LINE OUT (PLAY) jacks. |
| The sound is missing when this unit switches one disc to another. | The titles appear on the display during the playback of the part that has been recorded stretching over the two discs. | Press TEXT/TIME to switch the display to the indication of time. |
| A CD-R or CD-RW that has been recorded with this unit cannot be played on the other CD player or DVD player. | Your CD or DVD player is not compatible with CD-R or CD-RW discs. | Use a CD or DVD player compatible with CD-R or CD-RW discs. |
| | The CD-R or CD-RW disc has not been finalized. | Finalize the CD-R or CD-RW disc. |
| Sound "skips". | This unit and/or the component connected is being subjected to vibration or impact. | Relocate the unit. (This is not possible if the skipping sound is already on the recording due to vibrations or impact that occurred during recording.) |
| | The CD is dirty. | Clean the CD. |
| This unit makes noise. | Connection has not correctly been made. | Properly connect the audio pin cables. Replace the audio cables. |

| SYMPTOM | CAUSE | REMEDY |
|--|--|--|
| This unit does not operate properly. | The internal microcomputer has been frozen. | Turn off the power of this unit and then turn on again after about one minute. |
| There is rotation noise of the fan. | The temperature inside this unit rises. | The fan starts to rotate to cool off the temperature inside this unit. |
| A noise occurs at the change of the tracks that has been recorded from the analog record and edited. | A very low frequency component among the wow and flutter of the analog record is being output as a noise. | Improvement can be made by adding a short fade-in or fade-out to the track. |
| Remote control does not work. | The batteries of the remote control are too weak. | Replace 2 batteries with new ones. |
| | Remote control is from too far. Remote control is being used at an incorrect angle. | Use the remote control within 6m and 60 degrees radius. |
| | Direct sunlight or lighting (of an inverter type of fluorescent lamp, etc.) is striking the remote control sensor. | Change the position so that the remote control sensor is not exposed to strong lighting. |
| TV does not correctly function when the remote control is being used. | Remote control is being used near TV set with a remote control sensor. | Relocate this unit away from the TV or cover the TV's remote control sensor. |
| The picture on the TV is impaired. | The indoor antenna is used. | Use an outdoor antenna, or set this unit away from the TV set. |
| The HDD cannot be selected. | The HDD is not installed properly. | Install the HDD properly following the attached instruction. |
| | The HDD newly installed is not formatted on CDR-HD1300 you plan to use that HDD with. | Format it on CDR-HD1300 you plan to use with. |
| "Drive Check" appears on the display. | The HDD is not set to "slave" properly. | Set the HDD to "slave" properly following the instruction on the HDD. |

ABOUT PRODUCT INFORMATIONS

YAMAHA Audio and Video website contain the latest product information, etc. Refer to the website to check the latest information.

YAMAHA Audio and Video website:

<http://www.yamaha.co.jp/english/product/av/>

SPECIFICATIONS

■ Audio Performance

| | |
|-----------------------------------|------------------------------|
| Frequency response | 5 to 20,000 Hz, ± 0.5 dB |
| S/N ratio (EIAJ) | |
| Playback | 105 dB |
| Recording | 92 dB |
| Total harmonic distortion (1 kHz) | |
| Playback | 0.004 % |
| Recording | 0.006 % |
| Dynamic range | |
| Playback | 99 dB |
| Recording | 92 dB |

■ Laser Diode Properties

| | |
|--|---|
| Material | GaAlAs |
| Wavelength | 780 to 787 nm |
| Pulse Durations and Max. Output at the lens of the Laser Pickup Unit | |
| Read Mode | 0.85 mW (Continuous) |
| Write Mode | Max. 48 mW (for 212 ns, Min. Cycle 57.9 ns) |

■ Inputs

| | |
|----------------------------|-------------------------------|
| ANALOG LINE IN (REC) | |
| Type | Pin jack |
| Standard input level | 500 mV/24 k Ω |
| DIGITAL IN (OPTICAL) | |
| Type | Square optical connector jack |
| DIGITAL IN (COAXIAL) | |
| Type | Coaxial jack |
| Standard input level | 0.5 Vp-p (75 Ω) |

■ Outputs

| | |
|--|-------------------------------|
| ANALOG LINE OUT (PLAY) | |
| Type | Pin jack |
| Standard output level (1 kHz, 0 dB) | 2.0 \pm 0.5 Vrms |
| DIGITAL OUT (OPTICAL) | |
| Type | Square optical connector jack |
| DIGITAL OUT (COAXIAL) | |
| Type | Coaxial jack |
| Standard output level | 0.5 Vp-p (75 Ω) |
| PHONES | |
| Standard output level (Input 150 Ω shorted, -20 dB) | 300 mV/150 Ω |

■ General

| | |
|--------------------------------|---|
| Power supply | |
| [U.S.A. model] | AC 120 V, 60 Hz |
| [Australia model] | AC 240 V, 50 Hz |
| [U.K. and Europe models] | AC 230 V, 50 Hz |
| Power consumption | 37 W |
| Operating environment | |
| Temperature | +5 to 35°C |
| Humidity | 30 to 90 % RH (No condensation) |
| Dimensions (W x H x D) | 435 x 115.5 x 414.5 mm (17-1/8" x 4-1/2" x 16-5/16") |
| Weight | 8.4 kg (18 lbs. 8 oz.) with HDD 7.8 kg (17 lbs. 3 oz.) with no HDD |

Specifications are subject to change without notice.





CDR-HD1300 CDR-HD1300E

HDD Installation Manual

Manuel d'installation du disque dur

Festplattenspeicher-Installationshandbuch

Hårddiskinstallationsanvisningar

Manuale d'installazione dell'HDD

Manual de instalación del disco duro

Installatiehandleiding voor de harde schijf

INSTALLING THE HDD

There are some models that do not have a built-in hard disk drive (HDD) depending on the sales location. Please purchase a commercially available HDD for internal use and install it on this unit correctly, referring to the instruction below.

■ Required specifications of the HDD

Interface IDE/ATA type
Data Transfer Mode PIO mode 0 to 4 and
Multi-word DMA mode 0 to 2 compatible
Size 3.5-inch type
Capacity 20 to 137 GB

■ Installation procedures

Before installation

- Turn off the power of this unit and unplug the AC power cable from the wall outlet.
- Disconnect all the connections.
- Set the HDD to SLAVE (see description below).

MASTER or SLAVE setting on the HDD

It is necessary to set the HDD to MASTER or SLAVE when connecting the HDD to the component you plan to use. This unit is designed to operate HDD when it is set to SLAVE. Usually, setting procedure is written on the HDD itself.

Example: When setting the WD800AB model

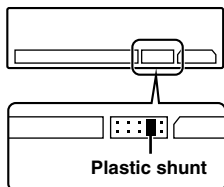

The HDD is set to slave by setting the plastic shunt at the second position from right of the jumper switch.

Example: When setting the ST340810A model

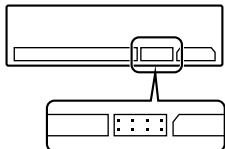

The HDD is set to slave by setting no plastic shunt at any position of the jumper switch.

1. Loosen the two fixing screws on the HDD slot door and open the HDD slot door.

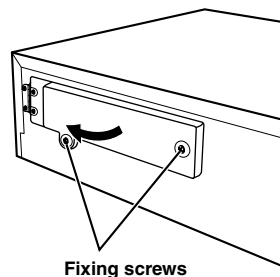

2. Pull out the HDD tray.

- Be careful not to hook the IDE cable and the power cable over the HDD tray.
- Do not apply the excessive force on the HDD tray.

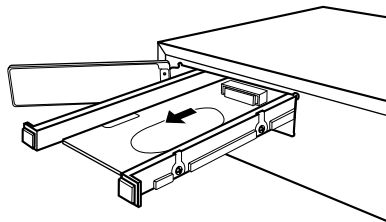

3. Place the HDD on the HDD tray.

- HDD is a very sensitive device. Be careful not to give any shock to it.

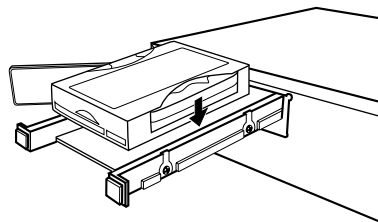

4. Tighten the four fixing screws.

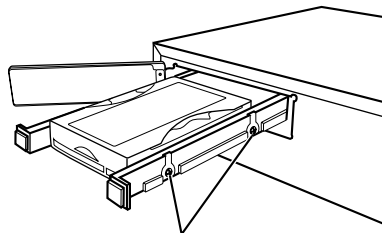

Fixing screws
(Screws are on the opposite side)

■ Installation procedures (continued)

5. Push the HDD tray and connect the IDE cable and the power cable.

- Make sure that the terminals and connectors are in the correct direction, and connect the cables securely.
- Static electricity can damage the HDD. Be careful not to touch the terminal pins and the circuit board.
- Do not apply excessive force on the HDD tray.

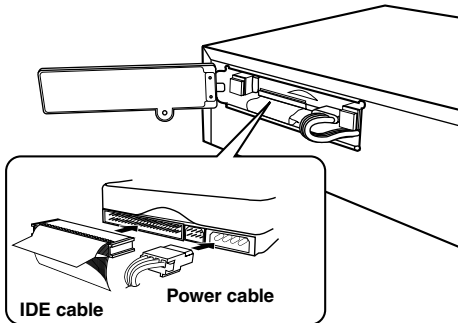

6. Close the HDD slot door and tighten the two fixing screws on the HDD slot door.

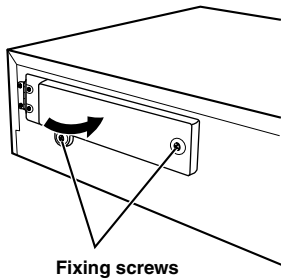

■ Formatting the HDD

If you install a new HDD, you need to format the HDD before using with this unit.

1. Connect the AC power cable to the wall outlet and turn on the power of this unit.

“Format Start?” appears on the display.

2. Press \triangleright /00.

“Format Really?” appears on the display.

3. Press \triangleright /00.

“Push PLAY KEY” appears on the display.

4. Press \triangleright /00.

“Wait” flashes on the display. After a few seconds, this unit starts formatting of the HDD. It takes approximately 15 seconds to complete formatting.

5. When formatting has been completed, “Format OK” appears on the display. Then the display returns to the one when the power of this unit was turned on.

Note

- Formatting is not necessary for the HDD that has been formatted on CDR-HD1300 you use. However, you need to format the HDD that has been formatted on other CDR-HD1300s following the steps on page 83 of the owner’s manual.

■ Recommended HDDs

Following HDDs have been proved by YAMAHA for their compatibility with CDR-HD1300 (as of July, 2003).

| Manufacturers | Series/Model No. | Capacity |
|-----------------|-----------------------------------|----------|
| Seagate | U6 Series/ST340810A | 40 GB |
| | U6CE Series/ST340810ACE | |
| | BARRACUDA ATA IV Series/ST380021A | 80 GB |
| | BARRACUDA 7200.7 Series/ST380011A | |
| Western Digital | Caviar Series/WD800AB | |

*See your local YAMAHA authorized dealer for additional information on HDDs.

*Company names and product names referred in this instruction are trademarks of their respective companies.

