

YAMAHA AX-V401

Natural Sound Stereo Integrated Amplifier

Préampli/ampli de puissance stéréo de la série "Natural Sound"

Natural Sound Stereo-Verstärker

Natural Sound Integrerad Stereo Förstärkare

Amplificatore integrato stereo a Suono Naturale

Amplificador integrado estéreo de Sonido Natural

Natural Sound Geïntegreerde Stereo Versterker



**OWNER'S MANUAL
MODE D'EMPLOI
BEDIENUNGSANLEITUNG
BRUKSANVISNING
MANUALE DI ISTRUZIONI
MANUAL DE INSTRUCCIONES
GEBRUIKSAANWIJZING**

SUPPLIED ACCESSORIES
ACCESSOIRES FOURNIS
MITGELIEFERTE ZUBEHÖRTEILE
MEDFÖLJANDE TILLBEHÖR
ACCESSORI IN DOTAZIONE
ACCESORIOS INCLUIDOS
BIJGELEVERDE ACCESSOIRES

- After unpacking, check that the following parts are contained.
- Après le déballage, vérifiez que les pièces suivantes sont incluses.
- Nach dem Auspacken überprüfen, ob die folgenden Teile vorhanden sind.
- Kontrollera efter det apparaten packats upp att följande delar finns med.
- Disimballato l'apparecchio, controllate di possedere tutte le parti menzionate.
- Desembale el aparato y verifique que los siguientes accesorios están en la caja.
- Controleer na het uitpakken of de volgende onderdelen voorhanden zijn.

- Remote Control Transmitter
- Emetteur de télécommande
- Fernbedienungsgeber
- Fjärrkontrollsändare
- Trasmittente del telecomando
- Transmisor del control remoto
- Afstandbediening

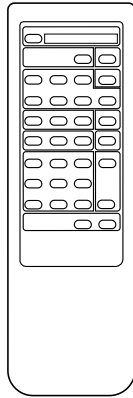

- Batteries (size AA, R6, UM-3)
- Piles (taille AA, R6, UM-3)
- Batterien (gröÙ AA, R6, UM-3)
- Batterier (storlek AA, R6, UM-3)
- Batterie (taglia AA, R6, UM-3)
- Pilas (tamaño AA, R6, UM-3)
- Batterijen (maat AA, R6, UM-3)

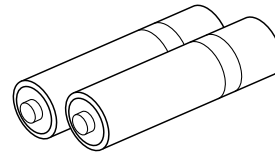

This product complies with the radio frequency interference requirements of the Council Directive 82/499/EEC and/or 87/308/EEC.

Cet appareil est conforme aux prescriptions de la directive communautaire 87/308/CEE.

Diese Geräte entsprechen der EG-Richtlinie 82/499/EWG und/oder 87/308/EWG.

Detta apparat överholder det gældende EF-direktiv vedrørende radiostøj.

Questo apparecchio è conforme al D.M.13 aprile 1989 (Direttiva CEE/87/308) sulla soppressione dei radiodisturbi.

Este producto está de acuerdo con los requisitos sobre interferencias de radio frecuencia fijados por el Consejo Directivo 87/308 CEE.

Dit product voldoet aan de EEG normen betreffende radio-frekwentie storingen 82/499/EEG en/of 87/308/EEG.

FEATURES

- **55W + 55W (8Ω) RMS Output Power, 0.04% THD, 20–20,000 Hz**
- **High Dynamic Power, Low Impedance Drive Capability**
- **Continuously Variable Loudness Control**
- **Source Direct Switch to Reproduce the Purest Source Sound**
- **Video Signal Input/Output Capability**
- **Remote Control Capability**

CONTENTS

Supplied Accessories	2
Caution	3
Connections	4
Operations	6
Remote Control Transmitter	9
Notes about the Remote Control Transmitter	10
Troubleshooting	11
Specifications	12

CAUTION: READ THIS BEFORE OPERATING YOUR UNIT.

1. To assure the finest performance, please read this manual carefully. Keep it in a safe place for future reference.
2. Install this unit in a cool, dry, clean place – away from windows, heat sources, sources of excessive vibration, dust, moisture and cold. Avoid sources of humming (transformers, motors). To prevent fire or electrical shock, do not expose the unit to rain or water.
3. Never open the cabinet. If something drops into the set, contact your dealer.
4. Do not use force on switches, controls or connection wires. When moving the unit, first disconnect the power plug and the wires connected to other equipment. Never pull the wire itself.
5. The openings on the cabinet assure proper ventilation of the unit. If these openings are obstructed, the temperature inside the cabinet will rise rapidly and eventually damage the circuits. Therefore, avoid placing objects against these openings and do not install the unit where the flow of air through the ventilation openings could be impeded.
6. Always set the VOLUME control to “– ∞” before starting the audio source play: increase the volume gradually to an appropriate level after the play has been started.
7. Do not attempt to clean the unit with chemical solvents; this might damage the finish. Use a clean, dry cloth.
8. Be sure to read the “TROUBLESHOOTING” section regarding common operating errors before concluding that the unit is faulty.
9. When not planning to use this unit for long periods of time (ie., vacation, etc.), disconnect the AC power plug from the wall outlet.
10. To prevent lightning damage, disconnect the AC power plug and disconnect the antenna cable when there is an electrical storm.
11. Grounding or polarization – Precautions should be taken so that the grounding or polarization of an appliance is not defeated.
12. AC outlet
Do not connect audio equipment to the AC outlet on the rear panel if that equipment requires more power than the outlet is rated to provide.
13. Voltage Selector (General Model only)
The voltage selector on the rear panel of this unit must be set for your local main voltage BEFORE plugging into the AC main supply.
Voltages are 110/120/220/240 V AC, 50/60 Hz.

IMPORTANT

Please record the serial number of this unit in the space below.

Serial No.:

The serial number is located on the rear of the unit. Retain this Owner’s Manual in a safe place for future reference.

WARNING

TO REDUCE THE RISK OF FIRE OR ELECTRIC SHOCK, DO NOT EXPOSE THIS UNIT TO RAIN OR MOISTURE.

CAUTION (FOR CANADA MODEL)

TO PREVENT ELECTRIC SHOCK, MATCH WIDE BLADE OF PLUG TO WIDE SLOT, AND FULLY INSERT.

FOR CANADIAN CUSTOMER

THIS DIGITAL APPARATUS DOES NOT EXCEED THE “CLASS B” LIMITS FOR RADIO NOISE EMISSIONS FROM DIGITAL APPARATUS SET OUT IN THE RADIO INTERFERENCE REGULATION OF THE CANADIAN DEPARTMENT OF COMMUNICATIONS.

CAUTION

The power switch does not disconnect the complete apparatus from the mains line.

Special Instructions for U.K. Model

IMPORTANT

THE WIRES IN THE MAINS LEAD ARE COLOURED IN ACCORDANCE WITH THE FOLLOWING CODE:

Blue: NEUTRAL
Brown: LIVE

As the colours of the wires in the mains lead of this apparatus may not correspond with the coloured markings identifying the terminals in your plug, proceed as follows:
The wire which is coloured BLUE must be connected to the terminal which is marked with the letter N or coloured BLACK. The wire which is coloured BROWN must be connected to the terminal which is marked with the letter L or coloured RED. Making sure that neither core is connected to the earth terminal of the three pin plug.

CONNECTIONS

- Before attempting to make any connections to or from this unit, be sure to first switch OFF the power to this unit and to any other components to which connections are being made.
- When making connections between this unit and other components, be sure all connections are made correctly, that is to say L (left) to L, R (right) to R, "+" to "+" and "-" to "-". Also, refer to the owner's manual for each component to be connected to this unit.

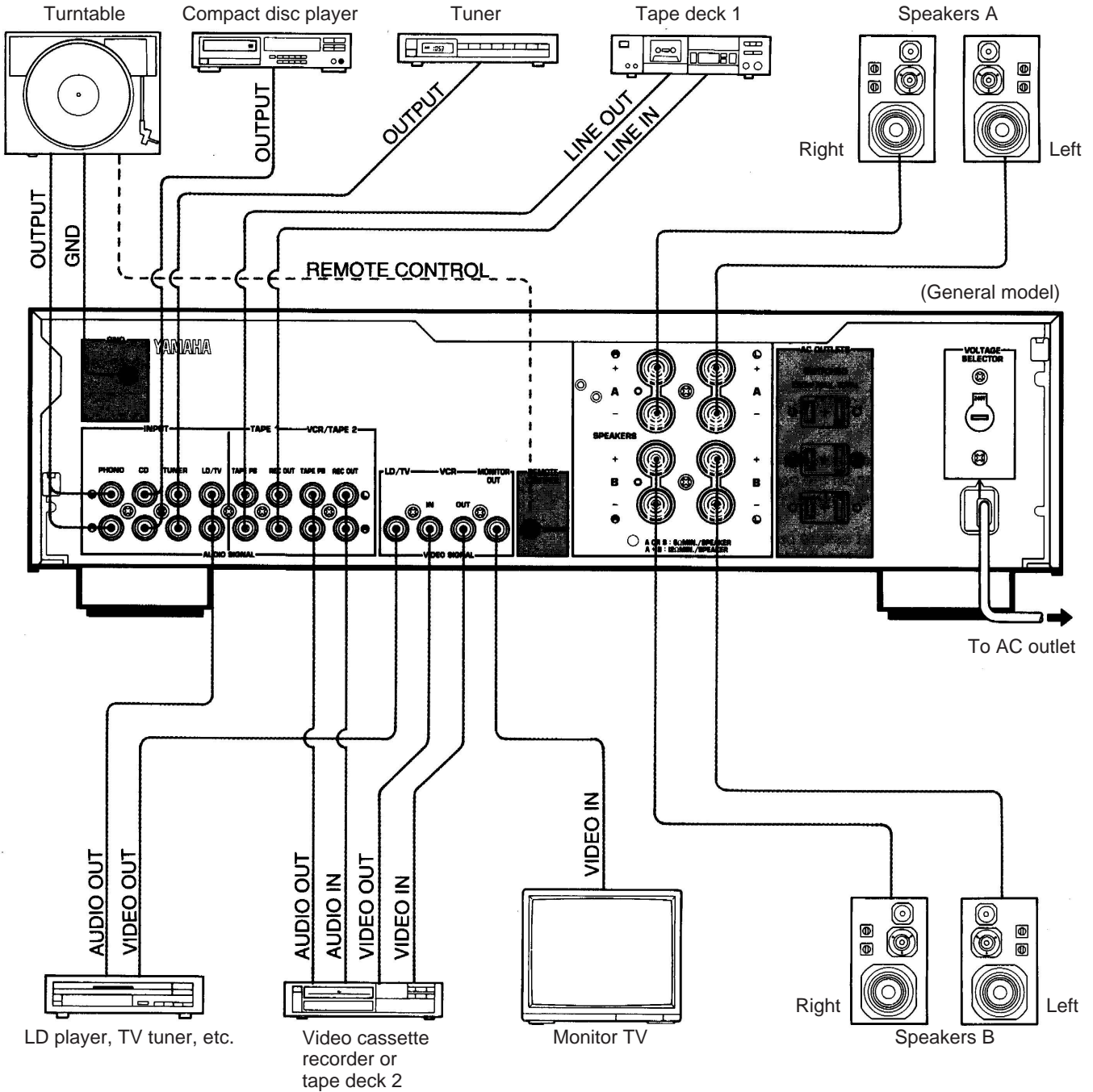

*  : Refer to "ABOUT THE ACCESSORY TERMINALS" on page 5.

* If a tape deck is connected to the VCR/TAPE 2 (AUDIO SIGNAL) terminals, there is no connection to the VCR (VIDEO SIGNAL) terminals.

CONNECTING SPEAKERS

Connect the **SPEAKERS** terminals to your speakers with wire of the proper gauge, cut to be as short as possible. If the connections are faulty, no sound will be heard from the speakers. Make sure that the polarity of the speaker wires is correct, that is, + and – markings are observed. If these wires are reversed, the sound will be unnatural and will lack bass.

Do not let the bare speaker wires touch each other and do not let them touch the metal parts of this unit as this could damage this unit and/or speakers.

- One or two speaker systems can be connected to this unit. If you connect only one speaker system, connect it to either the **SPEAKERS A** or **B** terminals.
- Use speakers with the specified impedance shown on the rear of this unit.

How to Connect:

Red: positive (+)
Black: negative (-)

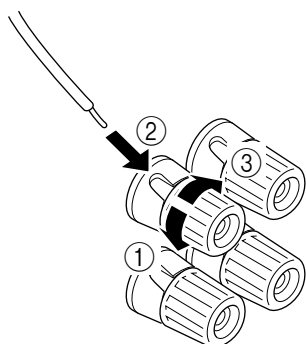

- ① Unscrew the knob.
- ② Insert the bare wire.
[Remove approx. 5mm (1/4") insulation from the speaker wires.]
- ③ Tighten the knob and secure the wire.

- Banana Plug connections are also possible (except for Scandinavian models). Simply insert the Banana Plug connector into the corresponding terminal.

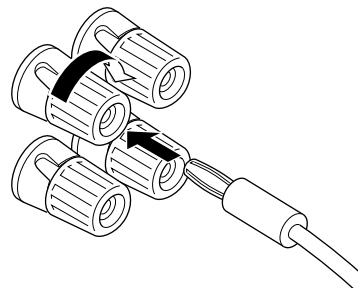

ABOUT THE ACCESSORY TERMINALS

AC OUTLETS

(Europe and General models).....3 SWITCHED OUTLETS
(Australia and U.K. models).....1 SWITCHED OUTLET
Use these to connect the power cords from your components to this unit.

The power to the **SWITCHED** outlets is controlled by this unit's **POWER** switch or the provided remote control transmitter's **POWER** key. These outlets will supply power to any component whenever this unit is turned on.

The maximum power (total power consumption of components) that can be connected to the **SWITCHED AC OUTLETS** is 100 watts (200 watts for General model only).

REMOTE CONTROL (PHONO) connector

If you have a YAMAHA turntable with the **RS** mark, connect it to this connector by using the cable provided with the turntable. This connection allows you to control the turntable from the provided remote control transmitter.

GND terminal (For turntable use)

Connecting the ground wire of the turntable to this terminal will minimize hum, but in some cases better results may be obtained with the ground wire disconnected.

OPERATIONS

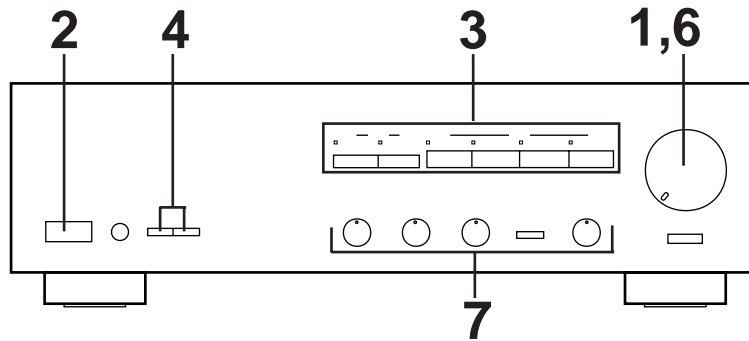

TO PLAY A SOURCE

1

VOLUME

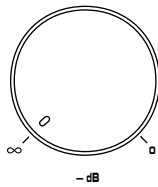

Set to the "∞" position.

2

POWER

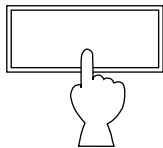

3

Select a desired input source.
(For video sources, turn the TV/monitor ON.)

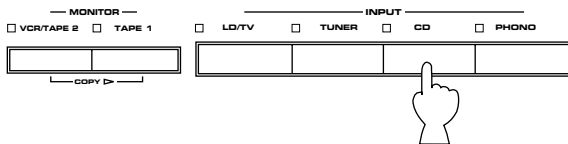

- * The indicator corresponding to the selected input source will illuminate.
- * Note that pressing on each input selector selects the source which is connected to the corresponding input terminals on the rear panel.

4

Select the speakers to be used.

SPEAKERS

A B

ON ON

OFF OFF

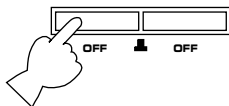

- * If you use two speaker systems, press both the A and B switches.

5

Play the source.

6

VOLUME

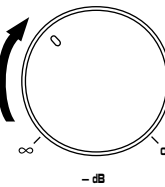

Adjust to the desired output level.

7

If desired, adjust the **BASS**, **TREBLE**, **BALANCE** and **LOUDNESS** controls, etc. (Refer to page 8.)

Note

In the step 3, if two or more program sources are selected at the same time (by using input selectors), be sure to remember the priority order of the input sources.

Priority order of audio sources: 1) **TAPE 1**, 2) **VCR/TAPE 2**, 3) **LD/TV**, **TUNER**, **CD** or **PHONO**.

Priority order of video sources: 1) **VCR/TAPE 2**, 2) **LD/TV**.

- If you select **LD/TV**, **TUNER**, **CD** or **PHONO**, be sure that **TAPE 1** and/or **VCR/TAPE 2** are not being selected.
- If you select **TAPE 1** and **VCR/TAPE 2**, and another input selector at the same time, the result will be the visual of **VCR/TAPE 2** and the sound from **TAPE 1**.
- If you select both **LD/TV** and **TAPE 1** at the same time, the result will be the visual of **LD/TV** and the sound from **TAPE 1**.
- Once you play the LD player, its visual will not be interrupted even if other input selectors except **VCR/TAPE 2** are selected.

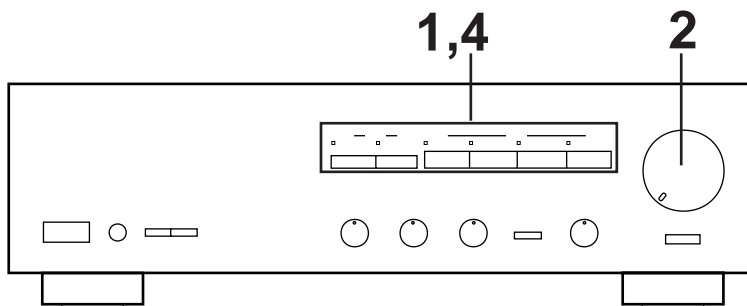

TO RECORD A SOURCE TO TAPE

1 Select the source to be recorded.

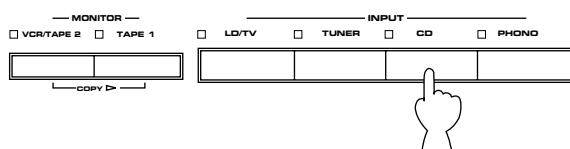

- * To dub from tape to tape, refer to the “Notes” shown below.
- * When selecting **LD/TV**, **TUNER**, **CD** or **PHONO**, be sure that **TAPE 1** and/or **VCR/TAPE 2** are not also selected.

2 Play the source and then turn the **VOLUME** control up to confirm the input source.

3 Set the tape deck or VCR in the recording mode.

4 To monitor the audio and/or video signals being recorded, press the input selector button for the audio or video tape recorder being used to make the recording.

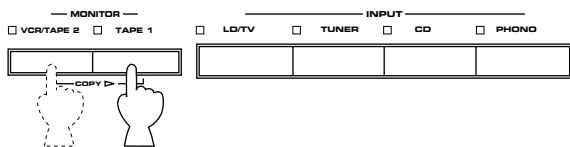

- * A red selector switch indicator takes priority over an orange indicator.

Notes

- **VOLUME**, **BASS**, **TREBLE**, **BALANCE** and **LOUDNESS** control settings have no effect on the material being recorded.
- To dub from tape to tape, only the following one way of dubbing can be performed. Note that when dubbing is performed from a VCR to an audio tape deck, only audio signals of the VCR will be dubbed to the audio tape deck.

SOURCE	RECORDER
Tape deck (or VCR) connected to the VCR/TAPE 2 terminals	→ Tape deck connected to the TAPE 1 terminals

STANDBY mode (Europe model only)

This unit is switched between the **POWER** on mode and the **STANDBY** mode by the **POWER** switch. (In the **STANDBY** mode, the unit is live and the indicator is half illuminated.) To switch off the unit completely, disconnect the AC power plug from the wall outlet.

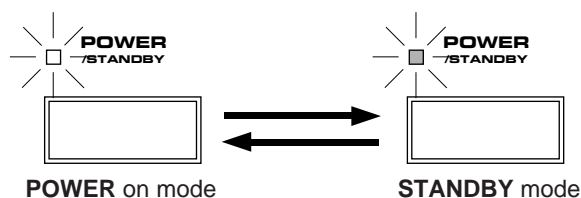

Adjusting the BALANCE control

Adjust the balance of the output volume to the left and right speakers to compensate for sound imbalance caused from speaker location or listening room conditions.

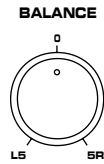

Adjusting the BASS and TREBLE controls

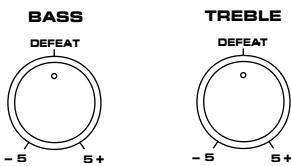

BASS : Turn this clockwise to increase (or counter-clockwise to decrease) the low frequency response.

TREBLE : Turn this clockwise to increase (or counter-clockwise to decrease) the high frequency response.

Selecting the SPEAKER system

Because one or two speaker systems can be connected to this unit, the **SPEAKERS** switches allow you to select speaker system **A** or **B**, or both at once.

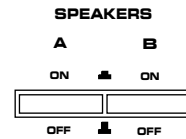

Adjusting the continuously variable LOUDNESS control

This control provides compensation for the human ears' loss of sensitivity to high and low-frequency ranges at low volume. This control is adjustable to retain full tonal range at any volume level.

1

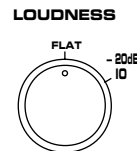

Set to the "FLAT" position.

2

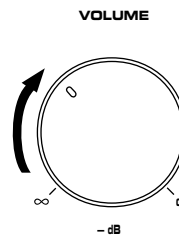

Set to the loudest listening level that you would listen to.

3

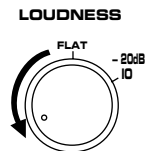

Turn so that the desired volume can be achieved.

Using the SOURCE DIRECT switch

You can enjoy the purest possible sound from your audio sources by setting this switch **ON**. By doing so, the audio signal bypasses the **BASS**, **TREBLE**, **BALANCE** and **LOUDNESS** controls, eliminating any alterations to the audio signal.



When you listen with headphones

Connect the headphones to the **PHONES** jack. When listening with headphones privately, set both the **SPEAKERS A** and **B** switches to the **OFF** position.

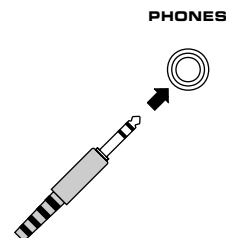

REMOTE CONTROL TRANSMITTER

The remote control transmitter provided with this unit is designed to control all the most commonly used functions of the unit. If the CD player, tuner, turntable, equalizer, and tape deck connected to this unit are YAMAHA components designed for remote control compatibility (components with an *ERS* mark), then this remote control transmitter will also control various functions of each component. Please consult YAMAHA dealer for information on which components are compatible with the remote control transmitter.

KEY FUNCTIONS

For Control of This Unit

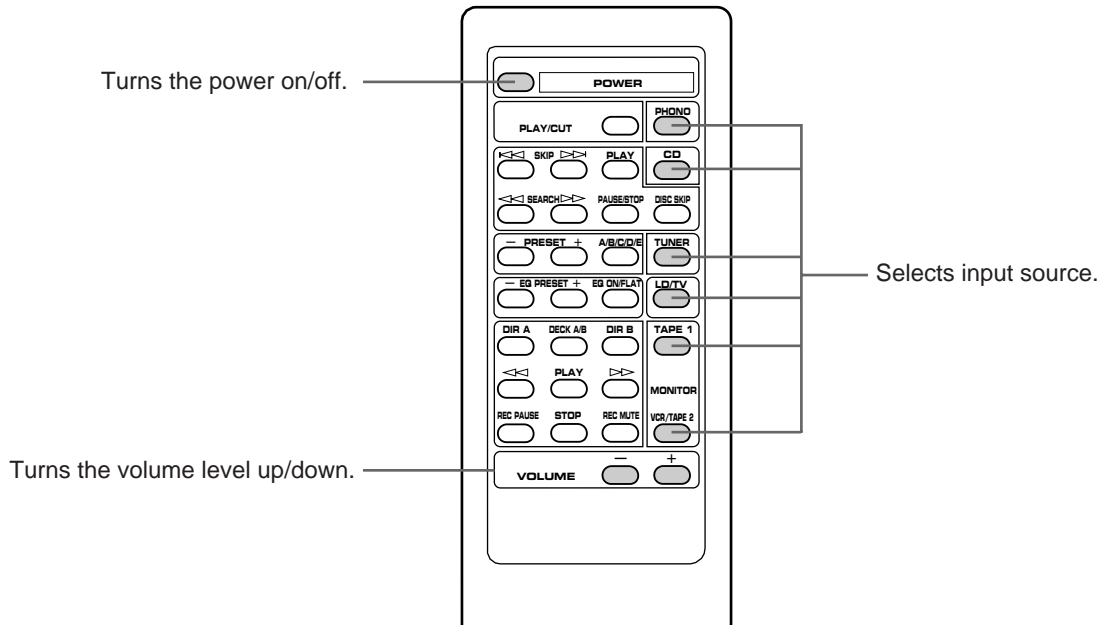

For Other Component Control

Identify the remote control transmitter keys with your component's keys. If these keys are identical, their function will be the same. On each key function, refer to the corresponding instruction on your component's manual.

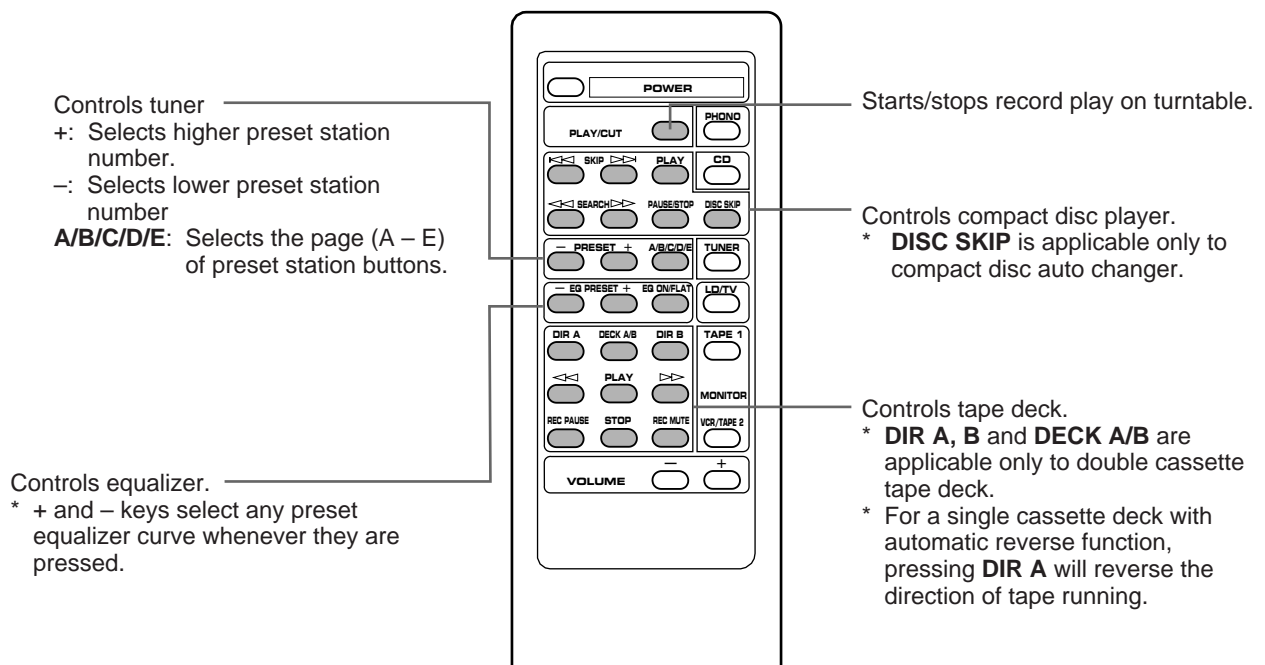

NOTES ABOUT THE REMOTE CONTROL TRANSMITTER

Battery installation

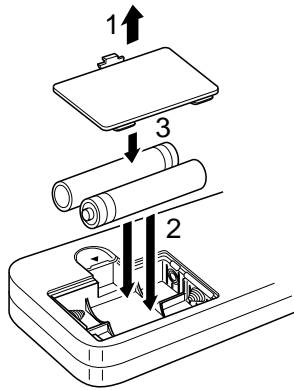

Battery replacement

If you find that the remote control transmitter must be used closer to the main unit, the batteries are weak. Replace both batteries with new ones.

Notes

- Use only AA, R6, UM-3 batteries for replacement.
- Be sure the polarities are correct. (See the illustration inside the battery compartment.)
- Remove the batteries if the remote control transmitter will not be used for an extended period of time.
- If batteries leak, dispose of them immediately. Avoid touching the leaked material or letting it come in contact with clothing, etc. Clean the battery compartment thoroughly before installing new batteries.

Remote control transmitter operation range

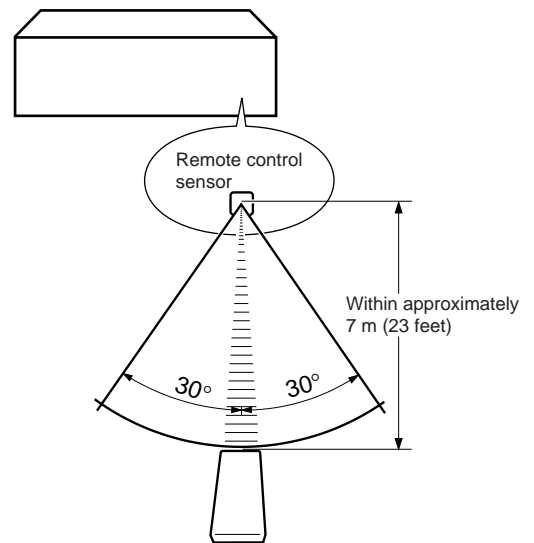

Notes

- There should be no large obstacles between the remote control transmitter and the main unit.
- If the remote control sensor is directly illuminated by strong lighting (especially an inverter type of fluorescent lamp etc.), it might cause the remote control transmitter not to work correctly. In this case, reposition the main unit to avoid direct lighting.

TROUBLESHOOTING

If the unit fails to operate normally, check the following points to determine whether the fault can be corrected by the simple measures suggested. If it cannot be corrected, or if the fault is not listed in the SYMPTOM column, disconnect the power cord and contact your authorized YAMAHA dealer or service center for help.

SYMPTOM	CAUSE	REMEDY
The unit fails to turn on when the POWER switch is pressed.	Power cord is not plugged in or is not completely inserted.	Firmly plug in the power cord.
No sound or no picture.	Incorrect output cord connections.	Connect the cords properly. If the problem persists, the cords may be defective.
	Appropriate input selector is not pressed.	Press the appropriate input selector corresponding to the input source.
The sound suddenly goes off.	The protection circuit has activated because of short circuit etc.	Turning the unit off and then on will reset the protection circuit.
Only one side speaker outputs the sound.	Incorrect setting of the BALANCE control.	Adjust it to the appropriate position.
	Incorrect cord connections.	Connect the cords properly. If the problem persists, the cords may be defective.
Sound "hums".	Incorrect cord connections.	Firmly connect the audio plugs. If the problem persists, the cords may be defective.
	No connection from the turntable to the GND terminal.	Make the GND connection between the turntable and this unit.
The volume level is low while playing a record.	The record is being played on a turntable with an MC cartridge.	The player should be connected to this unit through the MC head amplifier.
The remote control transmitter does not work.	Direct sunlight or lighting (of an inverter type of fluorescent lamp etc.) is striking the remote control sensor of the main unit.	Change position of the main unit.
The distance or range within which the remote control transmitter can be used decreases.	The batteries of this remote control transmitter are too weak.	Replace the batteries with new ones.
The sound is degraded when monitoring is performed by using the headphones connected to the compact disc player or cassette deck which are connected with this unit.	Power cord of this unit is not plugged.	Plug in the power cord.

SPECIFICATIONS

Minimum RMS Output Power per Channel 8 ohms, 20 Hz to 20 kHz, 0.04% THD55W+55W	Headphone Jack Rated Output/Impedance 8 ohms, 1 kHz, 0.04% THD Output Level.....0.4V Impedance.....390 ohms	Power Supply [U.S.A. and Canada models]AC 120V, 60 Hz [Australia and U.K. models]AC 240V, 50 Hz [Europe model]AC 230V, 50 Hz [General model]AC 110/120/220/240V, 50/60 Hz
6 ohms, 20 Hz to 20 kHz, 0.06% THD [Scandinavia and General models]60W+60W	Frequency Response (20 Hz to 20 kHz) CD/TUNER/LD-TV/TAPE/VCR0±0.5 dB	Power Consumption [Scandinavia model]130W [Europe (except Scandinavia) and General models]170W [Australia and U.K. models]200W
4 ohms, 20 Hz to 20 kHz, 0.1% THD [Australia and U.K. models]68W+68W	RIAA Equalization Deviation (20 Hz to 20 kHz) PHONO MM.....0±0.5 dB	AC Outlets [General model] 3 SWITCHED OUTLETS200W max. total [Europe model] 3 SWITCHED OUTLETS100W max. total [Australia and U.K. models] 1 SWITCHED OUTLET100W max. total
Dynamic Power per Channel (by IHF Dynamic Headroom measuring method) [General model] 8/6/4/2 ohms85/100/120/130W [Australia, Europe and U.K. models] 8/6/4/2 ohms90/105/125/140W	Total Harmonic Distortion (20 Hz to 20 kHz) PHONO MM to REC OUT (3 V)0.01% CD/TUNER/LD-TV/TAPE/VCR to SP OUT (27.5W/8 ohms)0.02%	Dimensions (W x H x D)435 x 131 x 301.5 mm (17-1/8" x 5-3/16" x 11-7/8")
DIN Standard Output Power per Channel 4 ohms, 1 kHz, 0.7% THD [Europe model only]70W	Signal-to-Noise Ratio (IHF-A Network) PHONO MM (5 mV Input Shorted)82 dB CD/TUNER/LD-TV/TAPE/VCR (Input Shorted)103 dB	Weight.....6.1 kg (13 lbs. 7 oz.)
IEC Power 6 ohms, 1 kHz, 0.04% THD [Europe model only]77W	Residual Noise (IHF-A Network)140 µV	AccessoriesRemote control transmitter Batteries
Power Band Width 8 ohms, 20W, 0.1% THD10 Hz to 40 kHz	Channel Separation (Vol. -30 dB) PHONO MM (Input Shorted 1 kHz)55 dB CD/TUNER/LD-TV/TAPE/VCR (Input 5.1 k-ohms Terminated 1 kHz)55 dB	Specifications subject to change without notice.
Damping Factor 8 ohms, 1 kHz50	Tone Control Characteristics BASS: Boost/cut.....±10 dB (50 Hz) TREBLE: Boost/cut.....±10 dB (20 kHz)	
Input Sensitivity/Impedance PHONO MM2.5 mV/47 k-ohms CD/TUNER/LD-TV/TAPE/VCR150 mV/50 k-ohms	Continuous Loudness Control-20 dB (1 kHz) (Level related equalization)	
Maximum Input Signal (1 kHz, 0.01% THD) PHONO MM80 mV	Gain Tracking Error (0 to -70 dB)3 dB	
Output Level/Impedance REC OUT150 mV/550 ohms		

YAMAHA

YAMAHA ELECTRONICS CORPORATION, USA 6660 ORANGETHORPE AVE., BUENA PARK, CALIF. 90620, U.S.A.
YAMAHA CANADA MUSIC LTD. 135 MILNER AVE., SCARBOROUGH, ONTARIO M1S 3R1, CANADA
YAMAHA ELECTRONIK EUROPA G.m.b.H. SIEMENSSTR. 22-34, D-2084 RELINGEN BEI HAMBURG, F.R. OF GERMANY
YAMAHA ELECTRONIQUE FRANCE S.A. 17 RUE DES CAMPANULES, LOGNES 77321 MARNE LA VALLEE CEDEX 2, FRANCE
YAMAHA ELECTRONICS (UK) LTD. YAMAHA HOUSE, 200 RICKMANSWORTH ROAD WATFORD, HERTS WD1 7JS, ENGLAND
YAMAHA SCANDINAVIA A.B. J A WETTERGRENS GATA 1, BOX 30053, 400 43 VÄSTRA FRÖLUNDA, SWEDEN
YAMAHA MUSIC AUSTRALIA PTY, LTD. 17-33 MARKET ST., SOUTH MELBOURNE, 3205 VIC., AUSTRALIA

YAMAHA CORPORATION
VN15690-1 Printed in Japan BWWB, Y ㊄