

# *NP-S2000*

---

*Network Player*

*Lecteur Réseau*

OWNER'S MANUAL  
MODE D'EMPLOI  
BEDIENUNGSANLEITUNG  
BRUKSANVISNING  
MANUALE DI ISTRUZIONI  
MANUAL DE INSTRUCCIONES  
GEBRUIKSAANWIJZIG  
ИНСТРУКЦИЯ ПО ЭКСПЛУАТАЦИИ

# HiFi Began with Yamaha

Yamaha's involvement with and passion for music goes back more than a century, to when we built our first reed organ in 1887. Now we are the world's leading producer of pianos and other musical instruments, and are involved with music in many other ways as well. We manufacture professional recording equipment, we design concert halls and we assist artists at concerts with set up and sound tuning.

This knowledge and experience benefits our production of audio components in many ways. We introduced our first HiFi (High Fidelity) turntable in 1955. Thereafter we were one of the first to offer mass-produced, high quality audio equipment, and introduced many legendary stereo components.

We hope you enjoy the genuine HiFi experience of Yamaha Natural Sound.



## Excellence in Audio Achievement

1920-  
1960s

**1922: We introduced a high-quality hand-wound phonograph.**

Since 1955, we have released many HiFi components, including turntables, tuners, integrated amplifiers, control amplifiers, power amplifiers and speakers.

**NS-20 Monitor Speaker**



NS-20



CA-1000

1970s

**CA-1000 Integrated Amplifier**

Featuring A-Class operation, the CA-1000 set the standard for integrated amplifiers.

**NS-690 Monitor Speaker**



NS-690



NS-1000M

**NS-1000M Monitor Speaker**

A truly legendary speaker still revered by HiFi enthusiasts

**B-1 Power Amplifier**

An innovative power amp that used FETs in all stages



B-1



C-2

**C-2 Control Amplifier**

Received top prize at the Milan International Music and HiFi Show.

**NS-10M Studio Monitor Speaker**

Became of the most popular studio monitors in the world.

**A-1 Integrated Amplifier**

**PX-1 Turntable**

Yamaha's first linear tracking turntable



PX-1



NS-10M

1980s

**B-6 Power Amplifier**

Pyramid-shaped power amplifier with X power supply and X amplifier

**GT-2000/L Turntable**

Ultra-precise heavyweight player embodying GT concept



B-6



GT-2000

**CD-1 CD Player**

First CD Player introduced in 1983

**B-2x Power Amplifier**

**MX-10000 Power Amplifier and**

**CX-10000 Control Amplifier**

Amplifier that redefined the capabilities of separate components

100th anniversary model



AX-2000



GT-CD1

**AX-2000 Integrated Amplifier**

High S/N ratio (128 dB), digital direct function equipped

**GT-CD1 CD Player**

Top-loading type player with integrated separate structure

**MX-1 Power Amplifier and CX-1 Control Amplifier**

1990s

2000s

**Soavo-1 and Soavo-2 Natural Sound Speaker Systems**

**A-S2000 Stereo Amplifier and**  
**CD-S2000 Super Audio CD Player**

**A-S1000 Stereo Amplifier and**  
**CD-S1000 Super Audio CD Player**



Soavo-1



Soavo-2

## CAUTION: READ THIS BEFORE OPERATING YOUR UNIT.

- 1 To assure the finest performance, please read this manual carefully. Keep it in a safe place for future reference.
- 2 Install this sound system in a well ventilated, cool, dry, clean place - away from direct sunlight, heat sources, vibration, dust, moisture, and/or cold. For proper ventilation, allow the following minimum clearances around this unit.  
Top: 10 cm (4 in)  
Rear: 10 cm (4 in)  
Sides: 10 cm (4 in)
- 3 Locate this unit away from other electrical appliances, motors, or transformers to avoid humming sounds.
- 4 Do not expose this unit to sudden temperature changes from cold to hot, and do not locate this unit in an environment with high humidity (i.e. a room with a humidifier) to prevent condensation inside this unit, which may cause an electrical shock, fire, damage to this unit, and/or personal injury.
- 5 Avoid installing this unit where foreign object may fall onto this unit and/or this unit may be exposed to liquid dripping or splashing. On the top of this unit, do not place:
  - Other components, as they may cause damage and/or discoloration on the surface of this unit.
  - Burning objects (i.e. candles), as they may cause fire, damage to this unit, and/or personal injury.
  - Containers with liquid in them, as they may fall and liquid may cause electrical shock to the user and/or damage to this unit.
- 6 Do not cover this unit with a newspaper, tablecloth, curtain, etc. in order not to obstruct heat radiation. If the temperature inside this unit rises, it may cause fire, damage to this unit, and/or personal injury.
- 7 Do not plug in this unit to a wall outlet until all connections are complete.
- 8 Do not operate this unit upside-down. It may overheat, possibly causing damage.
- 9 Do not use force on switches, knobs and/or cords.
- 10 When disconnecting the power cable from the wall outlet, grasp the plug; do not pull the cable.
- 11 Do not clean this unit with chemical solvents; this might damage the finish. Use a clean, dry cloth.
- 12 Only voltage specified on this unit must be used. Using this unit with a higher voltage than specified is dangerous and may cause fire, damage to this unit, and/or personal injury. Yamaha will not be held responsible for any damage resulting from use of this unit with a voltage other than specified.
- 13 To prevent damage by lightning, keep the power cable and outdoor antennas disconnected from a wall outlet or this unit during a lightning storm.
- 14 Do not attempt to modify or fix this unit. Contact qualified Yamaha service personnel when any service is needed. The cabinet should never be opened for any reasons.
- 15 When not planning to use this unit for long periods of time (i.e. vacation), disconnect the AC power plug from the wall outlet.
- 16 Be sure to read the “Troubleshooting” section on common operating errors before concluding that this unit is faulty.
- 17 Before moving this unit, press the power switch (on the main unit) downward to turn off this unit and then disconnect the AC power plug from the AC wall outlet.
- 18 Condensation will form when the surrounding temperature changes suddenly. Disconnect the power cable from the outlet, then leave this unit alone.
- 19 When using this unit for a long time, this unit may become warm. Turn the power off, then leave this unit alone for cooling.
- 20 Install this unit near the AC outlet and where the AC power plug can be reached easily.
- 21 The batteries shall not be exposed to excessive heat such as sunshine, fire or the like. When you dispose of batteries, follow your regional regulations.

As long as this unit is connected to the AC wall outlet, it is not disconnected from the AC power source even if you turn off this unit by the power switch (on the main unit).

### WARNING

TO REDUCE THE RISK OF FIRE OR ELECTRIC SHOCK, DO NOT EXPOSE THIS UNIT TO RAIN OR MOISTURE.

### WARNING

THE POWER SUPPLY CABLE OF THIS UNIT MUST BE CONNECTED TO THE MAIN SOCKET OUTLET VIA A PROTECTIVE EARTHING CONNECTION.

# CONTENTS

<b>SUPPLIED ACCESSORIES</b> .....	<b>2</b>
<b>GENERAL FLOWCHART</b> .....	<b>3</b>
<b>SYSTEM STRUCTURES</b> .....	<b>4</b>
Basic system.....	4
Full system .....	5
Roles of each component .....	6
Supported audio files.....	6
<b>PREPARATIONS</b> .....	<b>7</b>
Connections.....	7
Downloading the dedicated applications .....	8
Turning on this unit.....	9
<b>COMMUNICATION SETUP</b> .....	<b>10</b>
Media sharing setup .....	10
Media controller setup.....	10
<b>CONTENT BROWSING AND PLAYBACK</b> .....	<b>12</b>
Operations from PC browser.....	12
Operations from mobile device .....	13
Operations from main unit or remote control .....	14
Presetting favorite contents.....	15
<b>SETUP MENU</b> .....	<b>17</b>
Setup menu operations .....	17
Setup menu list.....	18
Advanced setup menu .....	19
<b>CONTROLS AND FUNCTIONS</b> .....	<b>20</b>
Front panel .....	20
Remote control.....	21
<b>ADDITIONAL INFORMATION</b> .....	<b>22</b>
Basic information on this unit .....	22
Troubleshooting .....	24
Front panel display messages.....	26
Taking care of this unit .....	26
<b>SPECIFICATIONS</b> .....	<b>27</b>

## About this manual

- This manual is produced prior to production. Design and specifications are subject to change in part as a result of improvements, etc. In case of differences between the manual and product, the product has priority.
- Pictures and illustrations (screen display, etc.) used in this manual may be different from actual products depending on use environments.
- Notes contain important information about safety and operating instructions.  indicates a tip for your operation.

## Introduction

Thank you for purchasing Yamaha Network Player NP-S2000. By connecting this unit to your home network and audio system, you can enjoy Internet radio (vTuner) or music files stored on your music servers (PCs and NAS) in the same network.

Also, you can select a playback source or operate this unit not only from the supplied remote control but also from an external media controller such as PC browsers and mobile devices.

-  If you are not familiar with “DLNA” or “Internet radio”, please read “Basic information on this unit” (☞ P.22) at the beginning.
- For details on compatible mobile devices, see “Mobile device” (☞ P.6).

## SUPPLIED ACCESSORIES

Check that you have received all of the following items.

- Remote control
- Batteries (AA, R6, UM-3) x 2
- Power cable
- RCA stereo cable
- TwonkyMedia server License Key brochure

### ■ Note on transport tape

Upon shipment from the factory, magnet feet are fixed with transport tape to this unit's feet. Remove the transport tape before placing this unit.

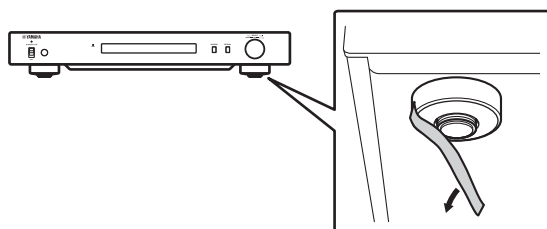

### ■ Installing the batteries

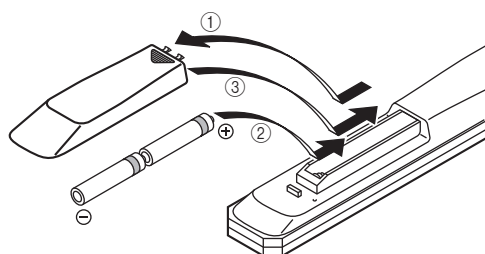

- ① Press the ▼ part and slide the battery cover off.
- ② Insert two supplied AA batteries according to the polarity markings (+ and -).
- ③ Slide the cover back until it snaps into place.

### Notes on remote controls and batteries

- Do not spill water or other liquids on the remote control.
- Do not drop the remote control.
- Do not leave or store the remote control in the following conditions:
  - places of high humidity, such as near a bath
  - places of high temperatures, such as near a heater or stove
  - places of extremely low temperatures
  - dusty places
- Insert the battery according to the polarity markings (+ and -).
- Change all batteries if the operation range of the remote control narrows.
- If the batteries run out, immediately remove them from the remote control to prevent an explosion or acid leak.
- If you find leaking batteries, discard the batteries immediately, taking care not to touch the leaked material. If the leaked material comes into contact with your skin or gets into your eyes or mouth, rinse it away immediately and consult a doctor. Clean the battery compartment thoroughly before installing new batteries.
- Do not use old batteries together with new ones. This may shorten the life of the new batteries or cause old batteries to leak.
- Do not use different types of batteries (such as alkaline and manganese batteries) together. Specification of batteries may be different even though they look the same.
- Before inserting new batteries, wipe the compartment clean.
- Dispose of batteries according to your regional regulations.

# GENERAL FLOWCHART

The following flowchart explains general setup procedures required to enjoy streaming music or Internet radio using this unit.

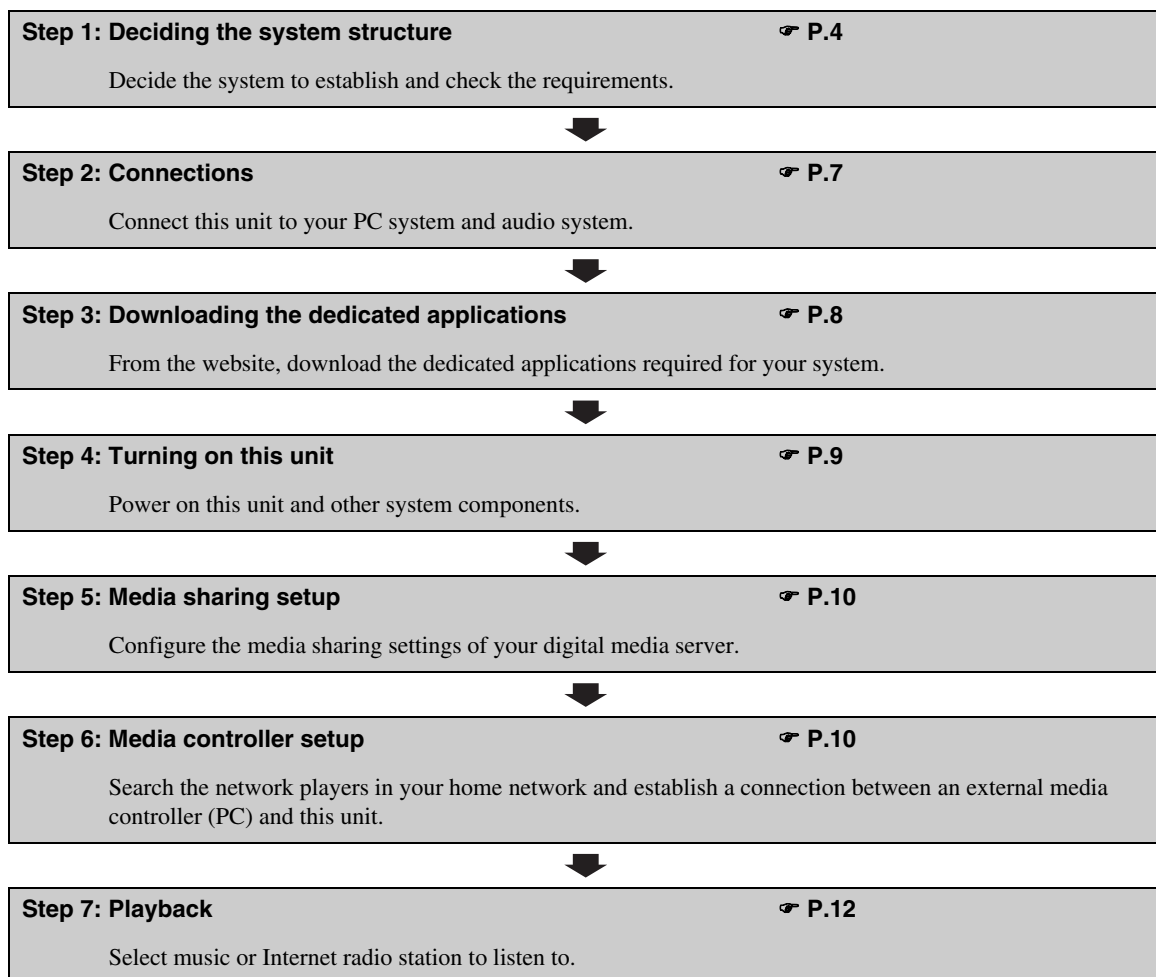

# SYSTEM STRUCTURES

This section describes two major system structure examples and what you can do with each system.

## Basic system

The following figure shows a minimum configuration to utilize the basic functions of this unit.

With this system structure, you can do...

- Easily establishing a communication between your PC and this unit using the dedicated PC setup application.
- Selecting playback source from a browser on any PC in the same network or remote control
  - Browsing music stored on your PC
  - Selecting Internet radio stations

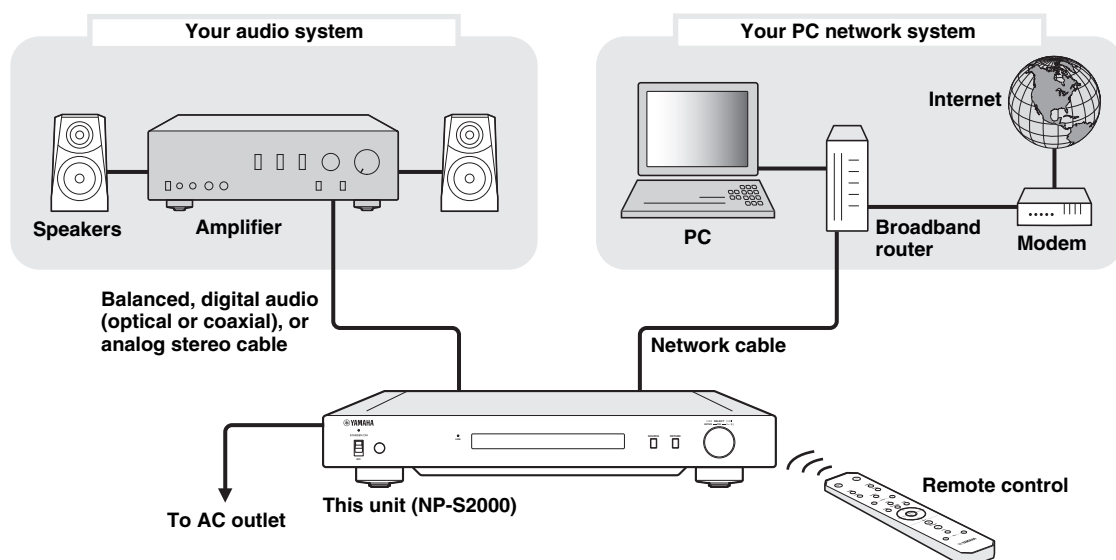

## ■ Requirements

To establish the “basic system”, all of the following requirements should be met.

### Audio system

- Your amplifier has an audio input jack.
- A speaker set is connected to your amplifier.



For details on a connection between your audio system and this unit, see “Connections” (P.7). Please also refer to the manual of your audio devices.

### PC network system

- Your PC is connected to the Internet via the broadband router.
- Your PC has a disc drive capable of ripping CDs and enough hard drive space to store audio files.



- For details on Internet connection, please refer to the manual of your network devices.
- For details on a connection and communication setup between your PC and this unit, see “Connections” (P.7) and “COMMUNICATION SETUP” (P.10).



## Full system

The following figure shows a recommended configuration to take full advantage of the functions of this unit.

With this system structure, you can do...

- All features listed in “Basic system” (☞ P.4)
- Delivering music stored on your NAS (without starting your PC)
- Selecting playback source from your mobile device
  - Browsing music stored on your PC and NAS
  - Selecting Internet radio stations

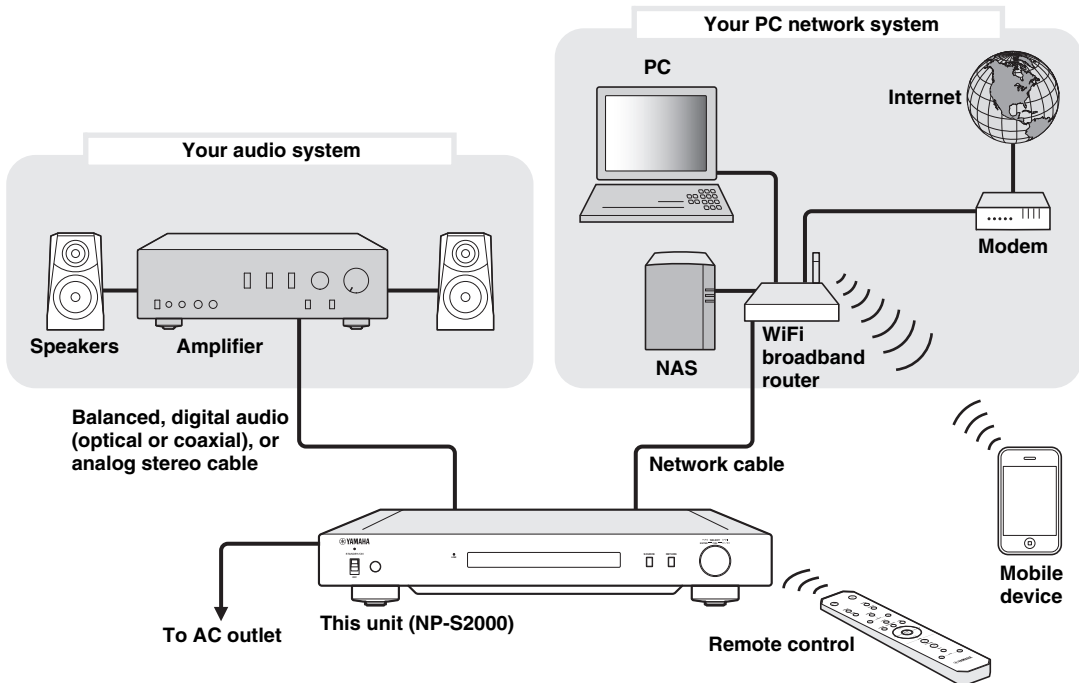

### ■ Requirements

To establish the “full system”, all of the following requirements should be met.

#### Audio system

- Your amplifier has an audio input jack.
- A speaker set is connected to your amplifier.



For details on a connection between your audio system and this unit, see “Connections” (☞ P.7). Please also refer to the manual of your audio devices.

#### PC network system

- Your PC is connected to the Internet via the WiFi broadband router.
- Your PC has a disc drive capable of ripping CDs and enough hard drive space to store audio files.
- Your NAS is compatible with DLNA and works with your PC and WiFi broadband router properly.



- For details on Internet connection, please refer to the manual of your network devices.
- For details on a connection and communication setup between your PC and this unit, see “Connections” (☞ P.7) and “COMMUNICATION SETUP” (☞ P.10).

#### Mobile device

- Your mobile device (☞ P.6) is wirelessly connected to the WiFi broadband router.

## Roles of each component

This section describes rolls of each component in the system.

### This unit (NP-S2000)

Decodes digital audio signals received from your PC network system and sends the signals to your audio system so that you can enjoy digital music stored on a PC or NAS, or Internet radio in high-quality sounds.

### Remote control

With the remote control, you can select a playback source or operate this unit while viewing information on the front panel display of this unit.

### Amplifier and speakers

Receive audio signals from this unit and produce sounds.

### PC

- Stores music files ripped from CDs or downloaded and works as a DLNA digital media server.
- By installing the dedicated PC setup application on your PC, you can configure the communication setup between your PC and this unit.
- With a browser (Internet Explorer 6.0 or later), you can select a playback source or operate this unit.

### Broadband router (WiFi broadband router)

Connects your PC and this unit to the Internet. A WiFi broadband router also works as a bridge between your mobile device and this unit in the network.

### NAS (Network attached storage)

Stores music files ripped from CDs or downloaded and works as a DLNA digital media server, enabling you to enjoy music without starting your PC.

### Mobile device

By installing the dedicated application on your mobile device, you can use it as an external controller. You can select playback source or operate this unit while viewing the screen of the mobile device.

Compatible mobile devices (as of June 2011)

- iPhone, iPod touch, iPad  
(iOS 4.0 or later)
- Android™ devices  
(Android OS 2.1 or later, ready for WiFi connection)

### Note

You may not be able to use the dedicated application depending on the operating system version of the mobile device

## Supported audio files

This unit supports the following audio files stored on a PC or a NAS.

### Audio format:

WAV, FLAC, MP3, AAC, WMA



- Playable audio formats vary depending on the media server.  
For example:
  - Windows Media Player 12 supports WAV, MP3, AAC and WMA.
  - Windows Media Player 11 supports WAV, MP3 and WMA.
  - TwonkyMedia server (supplied) supports all audio formats listed above.
- For details, visit “<http://download.yamaha.com/file/45350>”.
- We recommend WAV and FLAC as audio formats producing high-quality sounds.

### Sample rate:

96, 88.2, 64, 48, 44.1, 32, 24, 22.05, 16, 12, 11.025, 8 (kHz)

### Bit depth:

16, 24 (bit)

# PREPARATIONS

This section describes preparations required before operating this unit.

## Connections

Depending on the system structure you want to establish, make cable connections of the system components.

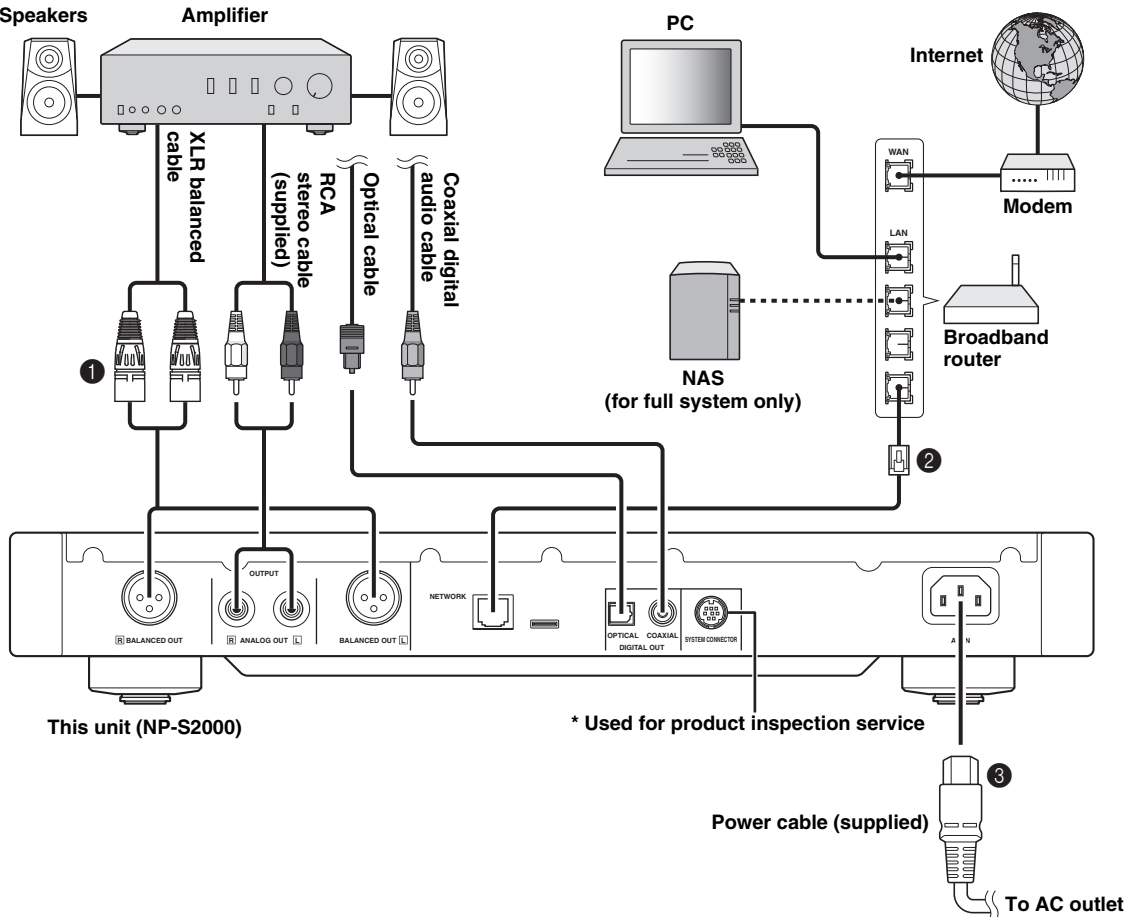

- ① Connect this unit to your amplifier with an XLR balanced cable, RCA stereo cable, coaxial digital audio cable or optical cable.



Select one of the audio connections shown above. If your amplifier is equipped with XLR balanced input jacks, we recommend a balanced connection for optimum audio performance.

- ② Connect this unit to your broadband router with an STP (shielded twisted pair) network cable (CAT-5 or higher straight cable).
- ③ Connect the power cable to AC IN and then plug into an AC outlet.

### Note

When using a digital connection, audio output may be interrupted at the beginning of a track depending on the audio system (amplifier, etc).

### About the spike feet

The feet of this unit include built-in spikes that can reduce the effect of vibrations on the set. To use the spikes, remove the magnet foot by pulling it. Also, you can adjust the height of each foot by rotating it if this unit is unstable.

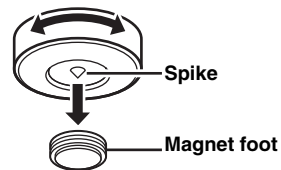

### Caution

The spikes may scratch the shelf or floor. We recommend you use a support when placing this unit on expensive furniture, etc.

### ■ About the BALANCED OUT jacks

The pin assignments for the BALANCED OUT jacks of this unit are shown below. Before connecting an XLR balanced cable, refer to the manual of your amplifier and verify that its XLR balanced input jacks are compatible with the pin assignments.

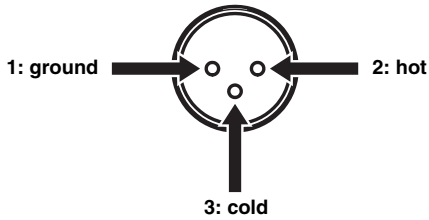

When connecting to this unit, be sure to match the pins and insert the connector of the “female” XLR balanced cable until you hear a click. When disconnecting, hold down the lever of the connector and then pull it out.

“Female” XLR connector

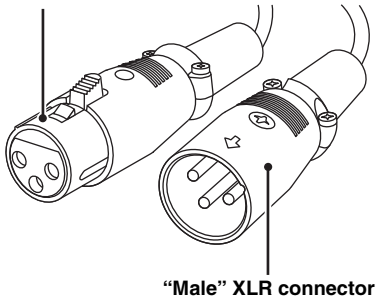

“Male” XLR connector

## Downloading the dedicated applications

Visit the following website for information about downloading the dedicated applications.  
<http://download.yamaha.com/file/45350>



The latest information on this unit (owner’s manual, FAQ, etc.) is also available in the download file.

### ■ Network Player Search

This application enables you to easily search the network players in your home network from your PC and start the browser to select playback source or operate this unit.

#### Note

Please read “License agreement” (P.28) before using this application.

### ■ Network Player Controller **Full System**

An application for mobile devices (P.6). This application enables you to select playback source or operate this unit from your mobile device.

### ■ TwonkyMedia server

For details, refer to “TwonkyMedia server License Key brochure” supplied with this unit.

## Turning on this unit

If you have established all cable connections, turn on this unit and other system components.

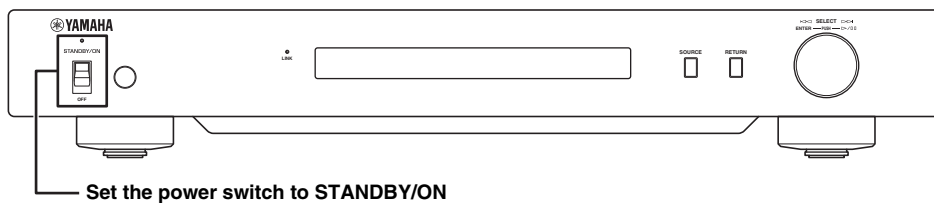

When the power switch on main unit is set to STANDBY/ON, you can switch this unit between on and standby by pressing the power button on the remote control (☞ P.21).

# COMMUNICATION SETUP

This section describes the setup required on digital media servers (PC or NAS) and controllers (PC).

## Media sharing setup

To enable a sharing of PC/NAS music contents over the network, configure the sharing setting of the media server.

### ■ Sharing setup on PC

When using Windows Media Player 12  
(on Windows 7)

- 1 In “Control Panel”, select “Choose homegroup and sharing options” under “Network and Internet”.
- 2 Check the “Stream my pictures, music, and videos to all devices on my home network” box and then select “Choose media streaming options”.
- 3 Select “Allowed” from the drop-down menu next to “NP-S2000”.
- 4 In the same way, select “Allowed” from the drop-down menu next to “Media programs on this PC and remote connections”.
- 5 Click “OK” to exit.



Since this unit supports Windows 7, you can directly control playback of this unit from Windows Media Player 12.

When using Windows Media Player 11

- 1 Start Windows Media Player 11 on your PC.
- 2 Select “Library” and then “Media Sharing”.

- 3 Check the “Share my media to” box, select the “NP-S2000” icon and then click “Allow”.

- 4 In the same way, select the icons for devices to be used as external media controllers (other PCs and mobile devices) and then click “Allow”.

- 5 Click “OK” to exit.

### When using TwonkyMedia server

If you have saved music files on your PC with iTunes (Non-DRM AAC/MP3 files), you can enable music streaming by using TwonkyMedia server. For details, refer to “TwonkyMedia server License Key brochure” supplied with this unit.

Change the media receiver setting on TwonkyMedia server to allow this unit and devices to be used as external media controllers (other PCs and mobile devices) to access TwonkyMedia server.

### ■ Sharing setup on NAS **Full System**

Refer to the manual of your NAS and change the media sharing setting on the NAS to allow this unit and devices to be used as external media controllers (other PCs and mobile devices) to access the NAS.

## Media controller setup

To select a playback source or operate this unit from external media controllers, first you need specify the IP address of this unit on a browser (Internet Explorer 6.0 or later). By using the dedicated application “Network Player Search”, you can easily search the network players in your home network from your PC and establish a connection.



- For details on the download of the dedicated applications, see “Downloading the dedicated applications” (P.8).
- To use your mobile devices as an external media controller, see “Operations from mobile device” (P.13).

## ■ Controller setup on PC

In this section, Windows 7 is used as an example.

### 1 Click the “NP Search.exe” in the download folder to start “Network Player Search”.

The “NETWORK PLAYER SEARCH” screen appears.

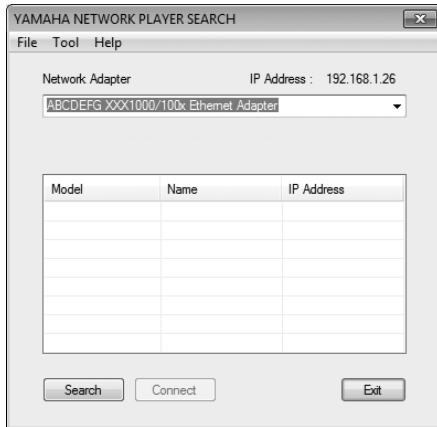

The menu language is automatically selected according to the language setting on the operating system. When using Windows, you can also select a language from “Language” under the “Tool” menu.

### 2 From the “Network Adapter” drop-down menu, select the network adapter connected to the network which this unit is being connected.

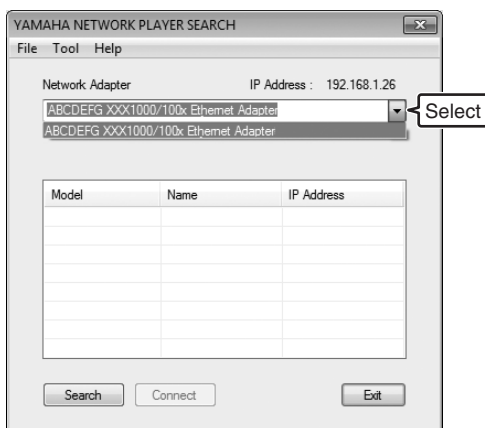

### 3 Click “Search” to search the network players in the network.

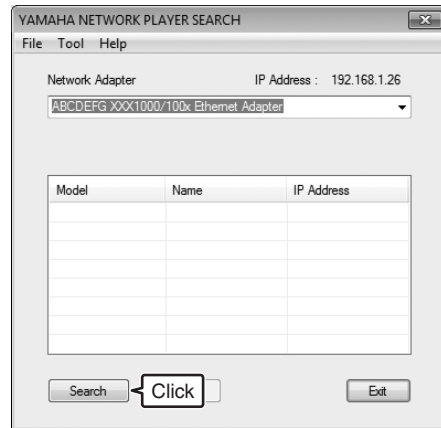

### 4 Select the model from the list and then click “Connect”.

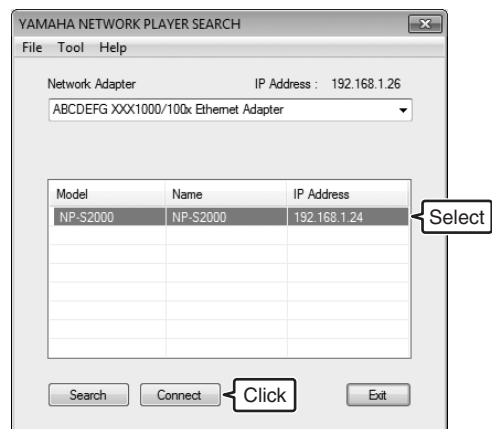

The network player control screen appears in the browser.

Now you are ready to select a playback source or operate this unit. For details, see “CONTENT BROWSING AND PLAYBACK” (P.12).



By adding the URL of the network player control screen (IP address of this unit) to the bookmark of the browser, you will be able to open it without using “Network Player Search” from the next time. However, the IP address of this unit may change if you are using a DHCP server.

# CONTENT BROWSING AND PLAYBACK

This section describes how to browse contents and start playback from the PC browser (Internet Explorer 6.0 or later), mobile device or front panel/remote control of this unit.

## Operations from PC browser

### 1 In the “Source” screen, select a source type.



- The “Source” screen is displayed after following the procedure in “Controller setup on PC” (P.11).
- Select “Setup” to configure the settings of this unit (P.17).



### 2 Select a menu item until you find a desired content and then start playback.

#### Menu screen

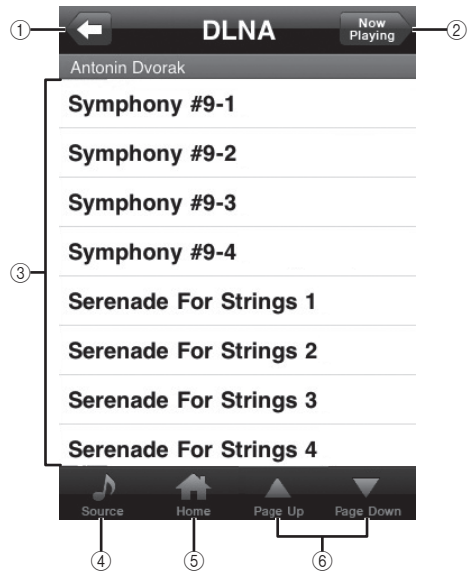

- ① **Return**  
Move to the previous menu screen.
- ② **Now Playing**  
Move to the playback information screen.
- ③ **Menu items**
- ④ **Source**  
Move to the “Source” screen.
- ⑤ **Home**  
Move to the top menu screen.
- ⑥ **Page Up/Page Down**  
Switch the pages of the menu list.



Playback information screen

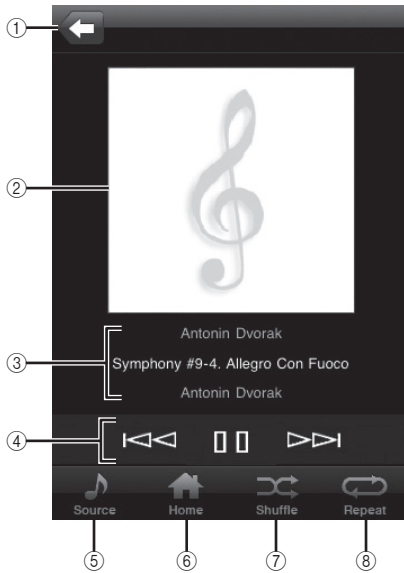

- ① **Return**  
Move to the previous screen.
- ② **Album art or station icon (if available)**
- ③ **Playback information**  
Shows the information on the playback content.
- ④ **Playback functions**  
DLNA: ▷ (play), || (pause), ◀◀ (skip backward), ▶▶ (skip forward)  
Internet Radio: ▷ (play), ◻ (stop)
- ⑤ **Source**  
Move to the “Source” screen.
- ⑥ **Home**  
Move to the top menu screen.
- ⑦ **Shuffle (for “DLNA” only)**  
Switch the shuffle mode (on, off).
- ⑧ **Repeat (for “DLNA” only)**  
Switch the repeat mode (repeat all, repeat single, off).

 You can register your favorite Internet Radio stations by accessing the “vTuner Radio Guide” website with a PC browser. To use this feature, you need the MAC address of this unit (P.18) and your e-mail address to create your personal account. For details, visit “<http://yradio.vtuner.com/>”.

Operations from mobile device

Full System

By using the dedicated application “Network Player Controller” (P.8), you can browse contents and start playback from your mobile device.

- 1 Tap the “NP Controller” icon on your mobile device to start “Network Player Controller”.



- 2 In the “Player Select” screen, select a network player to connect to.

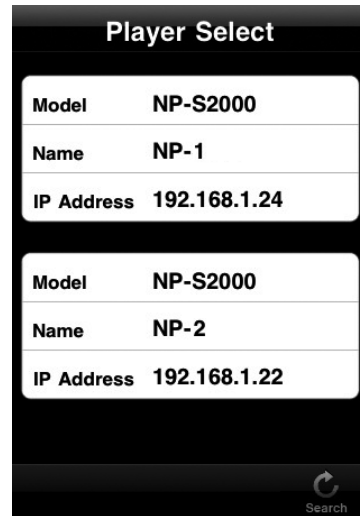

- 
- This screen is skipped when only one network player has been detected.
  - To search the network players again, tap “Search”.

- 3 Follow the procedure in “Operations from PC browser” (P.12).

- 
- To update the media server list, tap “Search”.
  - To reload the content list of the selected media server, tap “Load”. Reload the content list when you have added or deleted any content on the media server.

## Operations from main unit or remote control



For details on the controls on the front panel/remote control, see "CONTROLS AND FUNCTIONS" (P.20).

- 1 Press **SOURCE** repeatedly to select a source type.

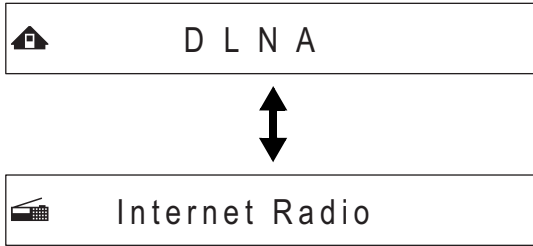
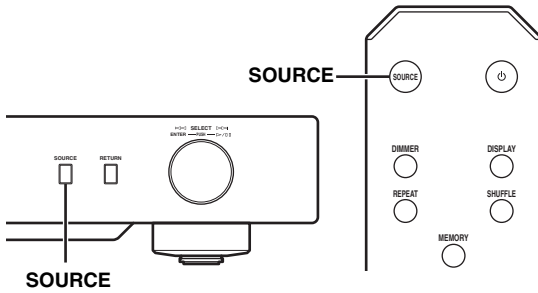

- 2 Use the following controls to select a menu item until you find a desired content.



### Main unit

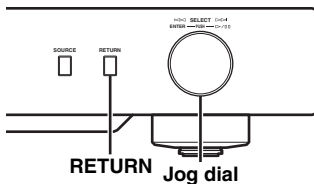

#### Jog dial

Rotate to select a menu item and press to confirm the selection.

#### RETURN

Show the upper-level menu in the front panel display.

### Remote control

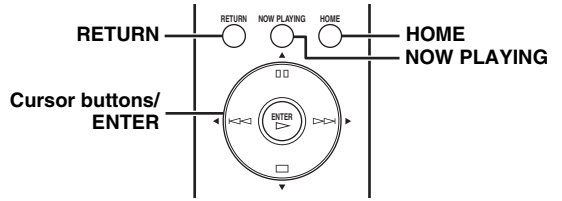

#### Cursor buttons/ ENTER

Press ▲/▼ to select a menu item (or press ◀/▶ repeatedly to select from the gauge) and press ENTER to confirm the selection.

#### RETURN

Show the upper-level menu in the front panel display.

#### HOME

Show the top-level menu in the front panel display.

#### NOW PLAYING

Show the playback information in the front panel display.

- 3 If playback starts, use the following controls to operate desired functions.



### Main unit

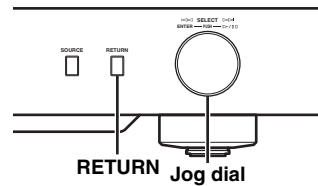

#### Jog dial

Rotate left to skip backward and right to skip forward. Press to start or pause playback.

#### RETURN

Show the previous menu in the front panel display.

Remote control

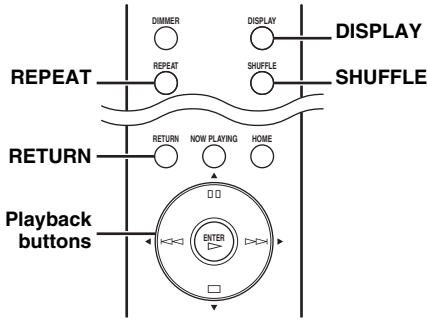

**Playback buttons**

DLNA: ▷ (play), ◻◻ (pause), ◀◀ (skip backward), ▶▶ (skip forward)  
 Internet Radio: ▷ (play), ◻ (stop)

**SHUFFLE (for “DLNA” only)**

Switch the shuffle mode (on, off).

**REPEAT (for “DLNA” only)**

Switch the repeat mode (repeat all, repeat single, off).

**DISPLAY**

Switch the playback information shown in the front panel display.

**RETURN**

Show the previous menu in the front panel display.



You can register your favorite Internet Radio stations by accessing the “vTuner Radio Guide” website with a PC browser. To use this feature, you need the MAC address of this unit (P.18) and your e-mail address to create your personal account. For details, visit “http://yradio.vtuner.com/”.

**Presetting favorite contents**

The preset function enables to make a quick access to your favorite contents (up to 20 contents) with the remote control.



For details on the controls on the front panel/remote control, see “CONTROLS AND FUNCTIONS” (P.20).

**■ Registering a favorite content as a preset**

You can preset music files or Internet radio stations.

**1 Start playback of the content you want to preset.**

**2 Press MEMORY to enter the preset mode.**

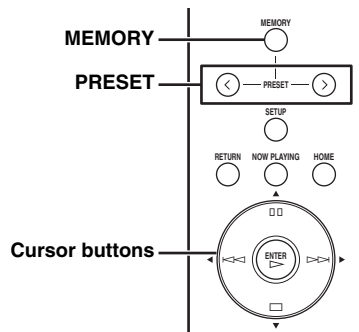

The empty preset number is automatically selected.



**3 To change the preset location, press PRESET or ◀▶ repeatedly.**

To switch between “1 to 10” and “11 to 20”, press ▲/▼.

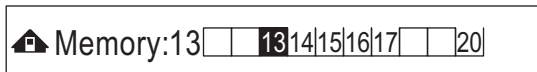

Preset locations already used are displayed without numbers. If one of these locations is selected, it will be replaced with new content.

**4 Press MEMORY again to confirm the selection.**

■ Playing back a preset content

**1 Press PRESET or ◀/▶ repeatedly to select a desired preset number.**

To switch between “1 to 10” and “11 to 20”, press ▲/▼.



Preset locations not in use are displayed without numbers.

**2 Within five seconds, press ▶.**

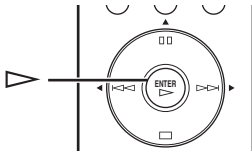

To clear all preset settings, execute “Initialize” in the advanced setup menu (☞ P.17). Make sure that this operation will reset all the settings of this unit to factory default.

**Notes**

- This unit does not recall the preset content in the following cases:
  - the PC which stores the selected content is turned off or disconnected from the network.
  - the selected Internet radio station is temporary unavailable or out of service.
  - the directory of the selected content has been changed.
- This unit memorizes the relative position of the preset contents in a directory. If you have added or deleted any music files to or from the directory, this unit may not recall the preset content correctly. In such cases, preset the contents again.

# SETUP MENU

You can configure the various settings of this unit using the setup menu.

## Setup menu operations

### ■ Operations from PC browser or mobile device

- 1 In the “Source” screen, select “Setup”.



- 2 Select a menu item to configure.

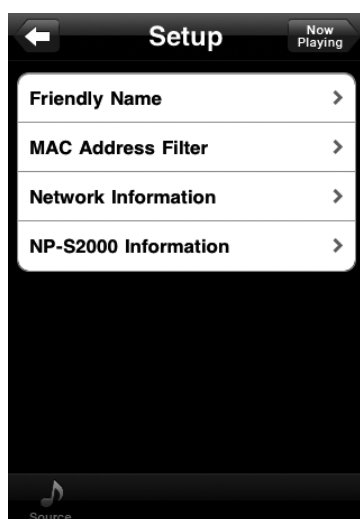

- 3 Select a parameter to be set.



You need to enter text for some menu items. In this case, select the entry field, use the keyboard to enter text and the Enter key to confirm it.

### ■ Operations from remote control



For details on the controls on the front panel/remote control, see “CONTROLS AND FUNCTIONS” (P.20).

- 1 Press **SETUP** to enter the setup menu (P.18).  
To make the advanced setup menu items (P.19) selectable, press **SETUP** while holding down **RETURN** (on the main unit).

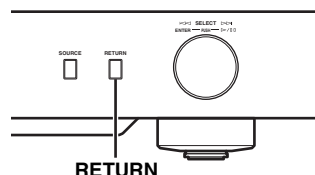
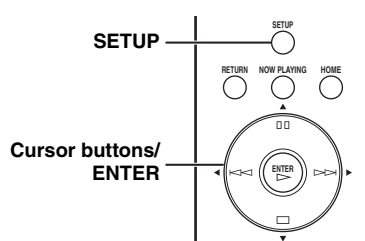

⇄ NETWORK Configuration

- 2 Press **▲/▼** to select a menu item to configure and then press **ENTER**.

For some menu items, repeat step 2 to select a submenu item.

⇄ Firmware Update

- 3 Press **▲/▼** to select a parameter and then press **ENTER**.



You need to enter a numerical address for some menu items. In this case, press **◀▶** to move the target, **▲/▼** to select a number and **ENTER** to confirm it.

## Setup menu list



Available setup menus vary depending on the controller.

Menu	Submenu	Settings ( <b>Bold:</b> default)	Function	Controller	
				Mobile device	Remote control
NETWORK Configuration	DHCP	<b>On</b> , Off	Select "On" to use the DHCP server to automatically configure the network settings of this unit or "Off" to configure manually.		○
	IP Address		Specify the IP address when "DHCP" is "Off". *1		
	Subnet Mask		Specify the subnet mask when "DHCP" is "Off". *1		
	Default Gateway		Specify the default gateway when "DHCP" is "Off". *1		
	DNS Server (P)		Specify the primary DNS server when "DHCP" is "Off". *1		
	DNS Server (S)		Specify the secondary DNS server when "DHCP" is "Off". *1		
NETWORK Information	MAC Address		The MAC address of this unit is shown. The MAC address is also used as a vTuner ID.	○	○
	Status		The network status of this unit is shown.		
	System		The serial number of this unit is shown.		
MAC Address Filter			Specify the MAC addresses (up to 5) of the network components that will be permitted access to this unit when "MAC Address Filter On/Off" is "On".	○	
Firmware Version (NP-S2000 Information)			The firmware version of this unit is shown.	○	○
Firmware Update			Update the firmware of this unit. – If "Firmware Update?" appears, press ENTER to start firmware update. Do not operate this unit until "Update OK" appears. – If the firmware is already the latest, "Update OK" appears.		○
Friendly Name			Specify the friendly name of this unit for Windows 7.	○	

\*1: When "DHCP" is "On", you can check the values (IP address, etc.) assigned by the DHCP server.

## Advanced setup menu

The following menu items are available only when you enter the setup menu by pressing SETUP (on the remote control) while holding down RETURN (on the main unit).

Menu	Settings ( <b>Bold:</b> default)	Function
MAC Address Filter On/Off	<b>On, Off</b>	Select "On" to permit access to this unit only from the network components with the MAC addresses specified in the "MAC Address Filter" list. Select "Off" to disable the MAC address filter function.
Gapless Playback	<b>On, Off</b>	Select "On" to skip silence between each track and enable seamless playback. Select "Off" to disable the gapless playback function. This function works on "DLNA" content only.  When "Gapless Playback" is "On", this unit starts to read data of the next track at the end of the current track. Some playback operations (skip, repeat, etc.) will work on the next track during this process.
vTuner Account Reset	<b>Yes, No</b>	Select "Yes" to reset the vTuner account. If "Please Power Off!" appears, turn off this unit. The reset operation will be reflected the next time you turn on this unit.  To create a new account, access " <a href="http://yradio.vtuner.com/">http://yradio.vtuner.com/</a> ". You need the MAC address of this unit and your e-mail address.
Initialize	<b>Yes, No</b>	Select "Yes" to reset the settings of this unit to factory default. If "Please Power Off!" appears, turn off this unit. The reset operation will be reflected the next time you turn on this unit.

# CONTROLS AND FUNCTIONS

## Front panel

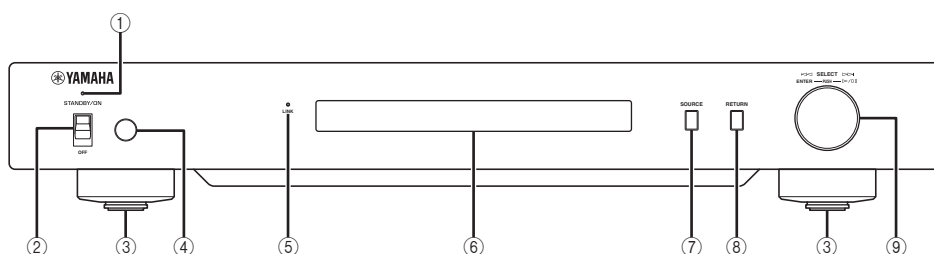

- ① **Power indicator**  
Lights up: This unit is turned on.  
Lights up dimly: This unit is standby.  
Off: This unit is turned off.
- ② **Power switch (☞ P.9)**  
Switches this unit between on/standby and off.
- ③ **Foot (☞ P.7)**  
Remove the magnet foot to use the spikes. Also, you can adjust the height of each foot by rotating it.
- ④ **Remote control sensor (☞ P.21)**  
Receives infrared signals from the remote control.
- ⑤ **LINK indicator**  
Lights up: This unit is connected to the network and an IP address has been assigned.  
Blinks: This unit is connected to the network but an IP address has not been assigned.  
Off: This unit is not connected to the network.
- ⑥ **Front panel display**  
Shows menu items or playback information.  
  
For details on display messages, see “Front panel display messages” (☞ P.26).
- ⑦ **SOURCE (☞ P.14)**  
Selects a source type.
- ⑧ **RETURN (☞ P.14)**  
Shows the upper-level menu in the front panel display.
- ⑨ **Jog dial (☞ P.14)**  
Rotate to select an item and press to confirm the selection.



## Remote control

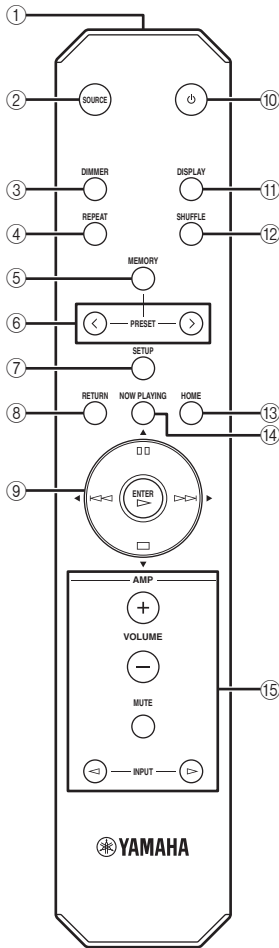

- ① **Remote control signal transmitter**  
Transmits infrared signals.
- ② **SOURCE** (☞ P.14)  
Selects a source type.
- ③ **DIMMER**  
Adjusts the brightness of the front panel display.
- ④ **REPEAT** (☞ P.15)  
Switches the repeat mode (repeat all, repeat single, off).
- ⑤ **MEMORY** (☞ P.15)  
Turns this unit to the preset mode.
- ⑥ **PRESET** (☞ P.15)  
Selects a preset number.
- ⑦ **SETUP** (☞ P.17)  
Shows the setup menu in the front panel display.
- ⑧ **RETURN** (☞ P.14)  
Shows the upper-level menu in the front panel display.
- ⑨ **Cursor buttons/ENTER** (☞ P.14 and 17)  
Use the cursor buttons to select an item and ENTER to confirm the selection, or control the playback functions.
- ⑩ **⏻ (power)** (☞ P.9)  
Switches this unit between on and standby.
- ⑪ **DISPLAY** (☞ P.15)  
Switch the playback information shown in the front panel display.
- ⑫ **SHUFFLE** (☞ P.15)  
Switches the shuffle mode (on, off).
- ⑬ **HOME** (☞ P.14)  
Shows the top-level menu in the front panel display.
- ⑭ **NOW PLAYING** (☞ P.14)  
Shows the playback information in the front panel display.
- ⑮ **Amplifier control buttons**  
Control the corresponding functions of Yamaha amplifier. For details, refer to the manual of your amplifier.



These buttons may not work on some Yamaha amplifiers.

### ■ Using the remote control

Aim the remote control directly at the remote control sensor on this unit during operation.

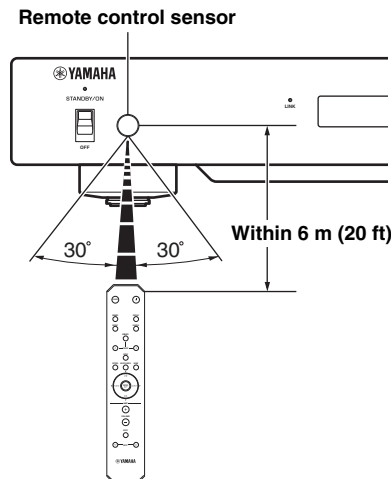

# ADDITIONAL INFORMATION

## Basic information on this unit

### ■ General

#### What is “Yamaha Network Player NP-S2000”?

NP-S2000 can play back the following audio sources:

- DLNA-compatible server (music files stored on a PC or a NAS)

For details, see “DLNA” below.

- Internet radio (vTuner)

For details, see “Internet radio” (☞ P.23).

Also, you can select a playback source or operate this unit from the remote control or an external media controller (PC browser or dedicated mobile device application).

#### Tell me about the network feature

By connecting this unit to your home network with an STP (shielded twisted pair) network cable (CAT-5 or higher straight cable), you can enjoy Internet radio or music files stored in the specified folder (directory) on the server in the same network. For information about the network devices and settings required to establish a home network, please consult your Internet service provider.

#### Can I preset favorite contents?

Yes you can. This unit has the preset function that enables you to make a quick access to your favorite contents (up to 20 contents) with the remote control. For details, see “Presetting favorite contents” (☞ P.15).

You can also register your favorite Internet Radio stations by accessing the “vTuner Radio Guide” website with a PC browser. To use this feature, you need the MAC address of this unit (☞ P.18) and your e-mail address to create your personal account. For details, access “<http://yradio.vtuner.com/>”.

#### Does this unit support multi-language display?

Yes, it does. The front panel display of this unit can display English, French, German, Spanish, Russian and Japanese used in track names, etc.

### ■ DLNA

#### What is “DLNA”?

It stands for Digital Living Network Alliance, and is a guideline to promote standardization of interconnection of home network devices such as digital consumer electronics.

DLNA components are separated into four types: Digital Media Server (DMS), Digital Media Renderer (DMR), Digital Media Player (DMP) and Digital Media Controller (DMC).

“DMS” is a device that is used to store or distribute digital contents such as music files. For this unit, PCs and NAS are regarded as “DMS”. “DMR” is a device to receive instructions from “DMC” and play back digital contents such as this unit. Similarly, “DMP” is a device to play back digital contents. “DMC” is a device to control digital contents. PC browsers and the mobile device application correspond to “DMC” for this unit.

#### What types of servers can I use to browse or play back music files with DLNA?

Use a DLNA-compatible server, such as one of the following devices.

##### PC compatible with Windows Media Player 12 or Windows Media Player 11

To browse folders (directories) on your PC from this unit, you need to change the media sharing setting of Windows Media Player 12 or Windows Media Player 11 to make those folders accessible from this unit. For details on Windows Media Player, please ask Microsoft Corporation.

##### PC with TwonkyMedia server installed

With a license key shown on the front cover of the “TwonkyMedia server License Key” brochure, you can download TwonkyMedia server for free.

It enables playback of FLAC files or music in the iTunes library on this unit.

#### How many servers can I connect to the network?

You can connect up to 16 servers.

**What types of audio formats can I play back on this unit?**

This unit supports monaural or stereo sounds of WAV, FLAC, MP3, AAC and WMA files.

For example, the following audio formats are not supported.

- Audio files with DRM (Digital Rights Management) such as music you purchased on iTunes Store
- ATRAC, multi-channel sounds of WAV and WMA files

**Can I play back music in the iTunes library on this unit?**

You can play back MP3, AAC and WMA files by installing TwonkyMedia server on your PC or using a NAS that supports playback of the iTunes library.

**■ Internet radio****Tell me about the Internet radio**

If this unit is connected to the Internet via your home network, you can listen to Internet radio stations using the vTuner Internet Radio station database service, providing a database of over 2000 radio stations around the world.

To enjoy Internet radio in a good condition, we recommend that you use a fast broadband connection to the Internet. For information about the broadband connection speed, please consult your Internet service provider.

**Can I add other Internet radio stations to the list?**

If you have found an Internet radio station that is not in the list, you can add it by accessing the “vTuner Radio Guide” website with a PC browser. To use this feature, you need the MAC address of this unit (P.18) and your e-mail address to create your personal account. For details, access “<http://yradio.vtuner.com/>”.

**Can I delete Internet radio stations that I do not listen to from the list?**

No, you cannot delete Internet radio stations from the list.

## Troubleshooting

Refer to the tables below if the unit does not function properly. If the problem you are experiencing is not listed below, or if the instruction below does not help, download the FAQ file from “<http://download.yamaha.com/file/45350>” and check it. Still, if you cannot find information you are looking for, contact the nearest authorized Yamaha dealer or service center.

### ■ General

Problem	Cause	Remedy	See page
This unit fails to turn on.	The power cable is not connected to AC IN on the main unit or not plugged into an AC outlet.	Connect the power cable firmly.	7
	This unit has been exposed to a strong external electric shock (such as lightning or strong static electricity).	Turn off this unit, disconnect the power cable, plug it back in after 30 seconds and then use it normally.	—
The power indicator on the front panel flashes.	There is a problem with the internal circuitries of this unit.	Turn off this unit, disconnect the power cable, and then contact the nearest authorized Yamaha dealer or service center.	—
No sound.	The audio cable connection between this unit and amplifier is improper.	Connect the audio cable firmly. If the problem persists, the audio cable may be defective.	7
	The input setting on the amplifier is incorrect.	Select the correct input (from this unit) on the amplifier.	—
Hum noise is heard.	The audio cable connection between this unit and amplifier is improper.	Connect the audio cable firmly. If the problem persists, the audio cable may be defective.	7
The remote control does not work or function properly.	Wrong distance or angle.	The remote control functions within a maximum range of 6 m (20 ft) and no more than 30 degrees off-axis from the front panel.	21
	Direct sunlight or lighting (from an inverter type of fluorescent lamp, etc.) is striking the remote control sensor of this unit.	Adjust the lighting angle, or reposition this unit.	—
	The batteries are weak.	Replace all batteries.	2
PRESET on the remote control does not work.	The digital media server that stores your preset content is turned off.	Turn on the digital media server and try again.	—
	The preset Internet Radio station is no longer in service.	Preset another favorite content.	15
The amplifier control buttons on the remote control do not work on the amplifier.	Your amplifier is not one of Yamaha amplifiers. (These buttons may not work on some Yamaha amplifiers.)	Use the remote control of your amplifier.	—

■ DLNA

Problem	Cause	Remedy	See page
This unit does not detect the digital media server (PC).	No server application is installed on the PC.	Install a DLNA-compatible server application such as Windows Media Player 11, Windows Media Player 12 or TwonkyMedia server.	—
	Windows Media Player 11 or Windows Media Player 12 is not started on the PC.	Start Windows Media Player 11 or Windows Media Player 12 on the PC.	—
	The sharing setting of Windows Media Player 11 or Windows Media Player 12 is incorrect.	Change the media sharing setting of it to allow this unit to access the PC folder.	10
	Access to the PC is blocked by the Antivirus software installed on the PC.	Check the Antivirus software settings (firewall setting, etc.).	—
Some audio files cannot be played back on this unit.	You are trying to play back DRM audio files you purchased on iTunes Store.	You cannot play back DRM audio files you purchased on iTunes Store.	—
	You are trying to play back FLAC files stored on a PC without TwonkyMedia server.	Install TwonkyMedia server on the PC, or use a NAS that supports playback of FLAC files.	—

■ Internet radio

Problem	Cause	Remedy	See page
Some Internet radio stations cannot be played back.	The selected Internet radio station is currently not available.	It may not be available to listen because there might be a network problem, or the station might be broadcasting in limited hour. Also, the list may include the station that is already obsolete, because it takes time to update the list. Please try another station available.	—
There is a station with no sound even after playback starts.	The selected Internet radio station broadcasts audio silence currently.	Some Internet radio stations broadcast audio silence during particular periods of time in a day. Try the station later or select another station.	—

Problem	Cause	Remedy	See page
The sound from the Internet radio breaks sometimes.	Intermittent audio occurs depending on the network condition between your local network and the Internet station.	Try the station later or select another station. If the problem happens with any stations, your network itself may have a problem. To enjoy Internet radio in a good condition, we recommend that you use a fast broadband connection to the Internet. For information about the broadband connection speed, please consult your Internet service provider.	—

## Front panel display messages

Message	Status
<Access Denied>	Access to the media server has been denied.
<Access Error>	This unit cannot connect to the media server.
List Update	The content list of the media server has been updated.
<No Content>	This unit cannot find any content.
<No DLNA Server Found>	This unit cannot find any DLNA server.
<No Link>	This unit is not connected to the network.
<No Preset Memory>	No preset contents are registered.
<Not Available>	The operation you have performed is not available.
Please Wait	The specified file is being loaded.
<Preset Memory Error>	The content cannot be preset.
Preset No.XX is not Found.	The music file or Internet radio station registered to the selected preset number (XX) cannot be found.
<Unable to Play>	This unit cannot play back the specified file.

## Taking care of this unit

When you wipe this unit, do not use chemical solvents (alcohol, thinner, etc.). This may damage the finish. Use a clean, dry cloth. For heavy dirt, dampen a soft cloth in detergent diluted with the water, wring it out, and then clean this unit up with the cloth.

### ■ For the polish-finished side panels

Clean the side panels with a soft, dry cloth, such as a Yamaha Unicon cloth. For heavy dirt, use a Yamaha Piano Unicon. Be careful not to bump the side panels with metal, porcelain, or other hard objects, as this may damage the finish.

# SPECIFICATIONS

## INPUT/OUTPUT

- NETWORK
  - Ethernet connection .....100Base-TX/10Base-T
  - DLNA version ..... 1.5 (DMP/DMR supported)
  - Audio format (DLNA)..... WAV, FLAC, MP3, AAC, WMA
  - Audio format (Internet radio) .....MP3, WMA
  - Audio sample rate (DLNA)
    - ..... 96, 88.2, 64, 48, 44.1, 32, 24, 22.05, 16, 12, 11.025, 8 kHz
  - Bit depth (DLNA)..... 16, 24 bit
- BALANCED OUT ..... 2ch (L/R)
- ANALOG OUT ..... 2ch (L/R)
- DIGITAL OUT
  - Optical ..... × 1
  - Coaxial ..... × 1
- SYSTEM CONNECTOR (for product inspection service)..... × 1

## AUDIO SECTION

- Output level
  - 1 kHz, 0 dB, fs 44.1 kHz .....2.0 ± 0.3 V
- Signal to noise ratio (IHF-A network)
  - 1 kHz, 0 dB, fs 44.1 kHz ..... 116 dB or more
- Dynamic range
  - 1 kHz, 0 dB, fs 44.1 kHz ..... 100 dB or more
- Harmonic distortion
  - 1 kHz, 0 dB, fs 44.1 kHz .....0.002% or less
- Frequency response
  - fs 44.1 kHz.....2 Hz to 20 kHz, -3 dB
  - fs 48 kHz.....2 Hz to 24 kHz, -3 dB
  - fs 96 kHz.....2 Hz to 48 kHz, -3 dB

## GENERAL

- Power supply
  - [U.S.A. and Canada models] ..... AC 110 to 120 V, 50/60 Hz
  - [Other models] ..... AC 220 to 240 V, 50/60 Hz
- Power consumption ..... 30 W
- Standby power consumption (reference data) ..... 0.3 W
- Dimensions (W × H × D)..... 435 × 69 × 440 mm  
(17-1/8" × 2-3/4" × 17-3/8")
- Weight..... 12 kg (26.5 lb)

\* Please note that all specifications are subject to change without notice.

## iPod touch, iPhone, iPad

Macintosh, Mac OS, iPod touch and iTunes are trademarks of Apple Inc., registered in the U.S. and other countries. iPhone and iPad are trademarks of Apple Inc.

Android™ is a trademark of Google Inc.

Microsoft, Windows, Windows 7, Windows Vista, Windows XP, Windows Media Audio, Windows Media Player and Internet Explorer are either registered trademarks or trademarks of Microsoft Corporation in the United States and/or other countries.

TwonkyMedia is a registered trademark of PacketVideo Corporation.



**Fraunhofer** Institut  
Integrierte Schaltungen

MPEG Layer-3 audio coding technology licensed from Fraunhofer IIS and Thomson.

## ■ License agreement

### ATTENTION

PLEASE READ THIS SOFTWARE LICENSE AGREEMENT ("AGREEMENT") CAREFULLY BEFORE USING THIS SOFTWARE. YOU ARE ONLY PERMITTED TO USE THIS SOFTWARE PURSUANT TO THE TERMS AND CONDITIONS OF THIS AGREEMENT. THIS AGREEMENT IS BETWEEN YOU (AS AN INDIVIDUAL OR LEGAL ENTITY) AND YAMAHA CORPORATION ("YAMAHA").

BY DOWNLOADING, INSTALLING, COPYING, OR OTHERWISE USING THIS SOFTWARE YOU ARE AGREEING TO BE BOUND BY THE TERMS OF THIS LICENSE. IF YOU DO NOT AGREE WITH THE TERMS, DO NOT DOWNLOAD, INSTALL, COPY, OR OTHERWISE USE THIS SOFTWARE. IF YOU HAVE DOWNLOADED OR INSTALLED THE SOFTWARE AND DO NOT AGREE TO THE TERMS, PROMPTLY DELETE THE SOFTWARE.

### GRANT OF LICENSE AND COPYRIGHT

Yamaha hereby grants you the right to use one copy of the software program(s) and data ("SOFTWARE") accompanying this Agreement. The term SOFTWARE shall encompass any updates to the accompanying software and data. The SOFTWARE is owned by Yamaha and/or Yamaha's licensor(s), and is protected by relevant copyright laws and all applicable treaty provisions. While you are entitled to claim ownership of the data created with the use of SOFTWARE, the SOFTWARE will continue to be protected under relevant copyrights.

- You may use the SOFTWARE on a single computer.
- You may make one copy of the SOFTWARE in machine-readable form for backup purposes only, if the SOFTWARE is on media where such backup copy is permitted. On the backup copy, you must reproduce Yamaha's copyright notice and any other proprietary legends that were on the original copy of the SOFTWARE.
- You may permanently transfer to a third party all your rights in the SOFTWARE, provided that you do not retain any copies and the recipient reads and agrees to the terms of this Agreement.

### RESTRICTIONS

- You may not engage in reverse engineering, disassembly, decompilation or otherwise deriving a source code form of the SOFTWARE by any method whatsoever.
  - You may not reproduce, modify, change, rent, lease, or distribute the SOFTWARE in whole or in part, or create derivative works of the SOFTWARE.
  - You may not electronically transmit the SOFTWARE from one computer to another or share the SOFTWARE in a network with other computers.
  - You may not use the SOFTWARE to distribute illegal data or data that violates public policy.
  - You may not initiate services based on the use of the SOFTWARE without permission by Yamaha Corporation.
- Copyrighted data, including but not limited to MIDI data for songs, obtained by means of the SOFTWARE, are subject to the following restrictions which you must observe.
- Data received by means of the SOFTWARE may not be used for any commercial purposes without permission of the copyright owner.
  - Data received by means of the SOFTWARE may not be duplicated, transferred, or distributed, or played back or performed for listeners in public without permission of the copyright owner.
  - The encryption of data received by means of the SOFTWARE may not be removed nor may the electronic watermark be modified without permission of the copyright owner.

### TERMINATION

This Agreement becomes effective on the day that you receive the SOFTWARE and remains effective until terminated. If any copyright law or provisions of this Agreement is violated, the Agreement shall terminate automatically and immediately without notice from Yamaha. Upon such termination, you must immediately destroy the licensed SOFTWARE, any accompanying written documents and all copies thereof.

### DOWNLOADED SOFTWARE

If you believe that the downloading process was faulty, you may contact Yamaha, and Yamaha shall permit you to re-download the SOFTWARE, provided that you first destroy any copies or partial copies of the SOFTWARE that you obtained through your previous download attempt. This permission to re-download shall not limit in any manner the disclaimer of warranty set forth in Section 5 below.

### DISCLAIMER OF WARRANTY ON SOFTWARE

You expressly acknowledge and agree that use of the SOFTWARE is at your sole risk. The SOFTWARE and related documentation are provided "AS IS" and without warranty of any kind. NOTWITHSTANDING ANY OTHER PROVISION OF THIS AGREEMENT, YAMAHA EXPRESSLY DISCLAIMS ALL WARRANTIES AS TO THE SOFTWARE, EXPRESS, AND IMPLIED, INCLUDING BUT NOT LIMITED TO THE IMPLIED WARRANTIES OF MERCHANTABILITY, FITNESS FOR A PARTICULAR PURPOSE AND NON-INFRINGEMENT OF THIRD PARTY RIGHTS. SPECIFICALLY, BUT WITHOUT LIMITING THE FOREGOING, YAMAHA DOES NOT WARRANT THAT THE SOFTWARE WILL MEET YOUR REQUIREMENTS, THAT THE OPERATION OF THE SOFTWARE WILL BE UNINTERRUPTED OR ERROR-FREE, OR THAT DEFECTS IN THE SOFTWARE WILL BE CORRECTED.

### LIMITATION OF LIABILITY

YAMAHA'S ENTIRE OBLIGATION HEREUNDER SHALL BE TO PERMIT USE OF THE SOFTWARE UNDER THE TERMS HEREOF. IN NO EVENT SHALL YAMAHA BE LIABLE TO YOU OR ANY OTHER PERSON FOR ANY DAMAGES, INCLUDING, WITHOUT LIMITATION, ANY DIRECT, INDIRECT, INCIDENTAL OR CONSEQUENTIAL DAMAGES, EXPENSES, LOST PROFITS, LOST DATA OR OTHER DAMAGES ARISING OUT OF THE USE, MISUSE OR INABILITY TO USE THE SOFTWARE, EVEN IF YAMAHA OR AN AUTHORIZED DEALER HAS BEEN ADVISED OF THE POSSIBILITY OF SUCH DAMAGES. In no event shall Yamaha's total liability to you for all damages, losses and causes of action (whether in contract, tort or otherwise) exceed the amount paid for the SOFTWARE.

### THIRD PARTY SOFTWARE

Third party software and data ("THIRD PARTY SOFTWARE") may be attached to the SOFTWARE. If, in the written materials or the electronic data accompanying the Software, Yamaha identifies any software and data as THIRD PARTY SOFTWARE, you acknowledge and agree that you must abide by the provisions of any Agreement provided with the THIRD PARTY SOFTWARE and that the party providing the THIRD PARTY SOFTWARE is responsible for any warranty or liability related to or arising from the THIRD PARTY SOFTWARE. Yamaha is not responsible in any way for the THIRD PARTY SOFTWARE or your use thereof.

- Yamaha provides no express warranties as to the THIRD PARTY SOFTWARE. IN ADDITION, YAMAHA EXPRESSLY DISCLAIMS ALL IMPLIED WARRANTIES OF MERCHANTABILITY AND FITNESS FOR A PARTICULAR PURPOSE, as to the THIRD PARTY SOFTWARE.
- Yamaha shall not provide you with any service or maintenance as to the THIRD PARTY SOFTWARE.
- Yamaha is not liable to you or any other person for any damages, including, without limitation, any direct, indirect, incidental or consequential damages, expenses, lost profits, lost data or other damages arising out of the use, misuse or inability to use the THIRD PARTY SOFTWARE.

### GENERAL

This Agreement shall be interpreted according to and governed by Japanese law without reference to principles of conflict of laws. Any dispute or procedure shall be heard before the Tokyo District Court in Japan. If for any reason a court of competent jurisdiction finds any portion of this Agreement to be unenforceable, the remainder of this Agreement shall continue in full force and effect.

### COMPLETE AGREEMENT

This Agreement constitutes the entire agreement between the parties with respect to use of the SOFTWARE and any accompanying written materials and supersedes all prior or contemporaneous understandings or agreements, written or oral, regarding the subject matter of this Agreement. No amendment or revision of this Agreement will be binding unless in writing and signed by a fully authorized representative of Yamaha.



## Limited Guarantee for European Economic Area (EEA) and Switzerland

Thank you for having chosen a Yamaha product. In the unlikely event that your Yamaha product needs guarantee service, please contact the dealer from whom it was purchased. If you experience any difficulty, please contact Yamaha representative office in your country. You can find full details on our website (<http://www.yamaha-hifi.com/> or <http://www.yamaha-uk.com/> for U.K. resident).

The product is guaranteed to be free from defects in workmanship or materials for a period of two years from the date of the original purchase. Yamaha undertakes, subject to the conditions listed below, to have the faulty product or any part(s) repaired, or replaced at Yamaha's discretion, without any charge for parts or labour. Yamaha reserves the right to replace a product with that of a similar kind and/or value and condition, where a model has been discontinued or is considered uneconomic to repair.

### Conditions

1. The original invoice or sales receipt (showing date of purchase, product code and dealer's name) MUST accompany the defective product, along with a statement detailing the fault. In the absence of this clear proof of purchase, Yamaha reserves the right to refuse to provide free of charge service and the product may be returned at the customer's expense.
2. The product MUST have been purchased from an AUTHORISED Yamaha dealer within the European Economic Area (EEA) or Switzerland.
3. The product must not have been the subject of any modifications or alterations, unless authorised in writing by Yamaha.
4. The following are excluded from this guarantee:
  - a. Periodic maintenance and repair or replacement of parts due to normal wear and tear.
  - b. Damage resulting from:
    - (1) Repairs performed by the customer himself or by an unauthorised third party.
    - (2) Inadequate packaging or mishandling, when the product is in transit from the customer. Please note that it is the customer's responsibility to ensure the product is adequately packaged when returning the product for repair.
    - (3) Misuse, including but not limited to (a) failure to use the product for its normal purpose or in accordance with Yamaha's instructions on the proper use, maintenance and storage, and (b) installation or use of the product in a manner inconsistent with the technical or safety standards in force in the country where it is used.
    - (4) Accidents, lightning, water, fire, improper ventilation, battery leakage or any cause beyond Yamaha's control.
    - (5) Defects of the system into which this product is incorporated and/or incompatibility with third party products.
    - (6) Use of a product imported into the EEA and/or Switzerland, not by Yamaha, where that product does not conform to the technical or safety standards of the country of use and/or to the standard specification of a product sold by Yamaha in the EEA and/or Switzerland.
5. Where the guarantee differs between the country of purchase and the country of use of the product, the guarantee of the country of use shall apply.
6. Yamaha may not be held responsible for any losses or damages, whether direct, consequential or otherwise, save for the repair or replacement of the product.
7. Please backup any custom settings or data, as Yamaha may not be held responsible for any alteration or loss to such settings or data.
8. This guarantee does not affect the consumer's statutory rights under applicable national laws in force or the consumer's rights against the dealer arising from their sales/purchase contract.

## Information for Users on Collection and Disposal of Old Equipment and Used Batteries



These symbols on the products, packaging, and/or accompanying documents mean that used electrical and electronic products and batteries should not be mixed with general household waste. For proper treatment, recovery and recycling of old products and used batteries, please take them to applicable collection points, in accordance with your national legislation and the Directives 2002/96/EC and 2006/66/EC.



By disposing of these products and batteries correctly, you will help to save valuable resources and prevent any potential negative effects on human health and the environment which could otherwise arise from inappropriate waste handling.



For more information about collection and recycling of old products and batteries, please contact your local municipality, your waste disposal service or the point of sale where you purchased the items.



### [Information on Disposal in other Countries outside the European Union]

These symbols are only valid in the European Union. If you wish to discard these items, please contact your local authorities or dealer and ask for the correct method of disposal.

### Note for the battery symbol (bottom two symbol examples):

This symbol might be used in combination with a chemical symbol. In this case it complies with the requirement set by the Directive for the chemical involved.

**Pb**

- Information about software
- Information sur le logiciel
- Information uber Software
- Information om programvara
- Informazioni sul software
- Información sobre el software
- Informatie over software
- Информация о программном обеспечении

This product uses the following free software.  
For information (copyright, etc) about each software, read the original sentences stated below.

### About zlib Library

#### Copyright notice:

©1995-2010 Jean-loup Gailly and Mark Adler  
This software is provided 'as-is', without any express or implied warranty. In no event will the authors be held liable for any damages arising from the use of this software.

Permission is granted to anyone to use this software for any purpose, including commercial applications, and to alter it and redistribute it freely, subject to the following restrictions:

1. The origin of this software must not be misrepresented; you must not claim that you wrote the original software. If you use this software in a product, an acknowledgment in the product documentation would be appreciated but is not required.
2. Altered source versions must be plainly marked as such, and must not be misrepresented as being the original software.
3. This notice may not be removed or altered from any source distribution.

Jean-loup Gailly	Mark Adler
jloup@zip.org	madler@alumni.caltech.edu

If you use the zlib library in a product, we would appreciate \*not\* receiving lengthy legal documents to sign. The sources are provided for free but without warranty of any kind. The library has been entirely written by Jean-loup Gailly and Mark Adler; it does not include third-party code.

If you redistribute modified sources, we would appreciate that you include in the file ChangeLog history information documenting your changes. Please read the FAQ for more information on the distribution of modified source versions.

### About FLAC codec Library

Copyright ©2000,2001,2002,2003,2004,2005,2006,2007, 2008,2009 Josh Coalson  
Redistribution and use in source and binary forms, with or without modification, are permitted provided that the following conditions are met:

- Redistributions of source code must retain the above copyright notice, this list of conditions and the following disclaimer.
- Redistributions in binary form must reproduce the above copyright notice, this list of conditions and the following disclaimer in the documentation and/or other materials provided with the distribution.
- Neither the name of the Xiph.org Foundation nor the names of its contributors may be used to endorse or promote products derived from this software without specific prior written permission.

THIS SOFTWARE IS PROVIDED BY THE COPYRIGHT HOLDERS AND CONTRIBUTORS "AS IS" AND ANY EXPRESS OR IMPLIED WARRANTIES, INCLUDING, BUT NOT LIMITED TO, THE IMPLIED WARRANTIES OF MERCHANTABILITY AND FITNESS FOR A PARTICULAR PURPOSE ARE DISCLAIMED. IN NO EVENT SHALL THE FOUNDATION OR CONTRIBUTORS BE LIABLE FOR ANY DIRECT, INDIRECT, INCIDENTAL, SPECIAL, EXEMPLARY, OR CONSEQUENTIAL DAMAGES (INCLUDING, BUT NOT LIMITED TO, PROCUREMENT OF SUBSTITUTE GOODS OR SERVICES; LOSS OF USE, DATA, OR PROFITS; OR BUSINESS INTERRUPTION) HOWEVER CAUSED AND ON ANY THEORY OF LIABILITY, WHETHER IN CONTRACT, STRICT LIABILITY, OR TORT (INCLUDING NEGLIGENCE OR OTHERWISE) ARISING IN ANY WAY OUT OF THE USE OF THIS SOFTWARE, EVEN IF ADVISED OF THE POSSIBILITY OF SUCH DAMAGE.

#### Notice for Windows Media DRM

This product is protected by certain intellectual property rights of Microsoft. Use or distribution of such technology outside of this product is prohibited without a license from Microsoft. Content owners use Windows Media digital rights management technology (WMDRM) to protect their intellectual property, including copyrights. This device uses WMDRM software to access WMDRM protected content. If the WMDRM software fails to protect the content, content owners may ask Microsoft to revoke the software's ability to use WMDRM to play or copy protected content. Revocation does not affect unprotected content. When you download licenses for protected content, you agree that Microsoft may include a revocation list with the licenses. Content owners may require you to upgrade WMDRM to access their content. If you decline an upgrade, you will not be able to access content that requires the upgrade.



JUTBG

**NP-S2000****追加情報****日本語**

機能変更により、再生可能なフォーマットに Apple Lossless フォーマットが追加されました。  
ソフトウェアの著作権などについては裏面に示した原文をお読みください。

**Additional information****English**

The additional feature on this product supports Apple Lossless audio format. For detailed information about the Copyright and License, please see the opposite side of this page.

**Complément d'informations****Français**

La fonction ajoutée à ce produit est compatible avec le format de fichier audio Apple Lossless. Pour plus de détails sur les droits d'auteur et la licence, voyez le verso de ce document.

**Zusätzliche Informationen****Deutsch**

Das Gerät unterstützt jetzt außerdem den Audio-Codec Apple Lossless. Detaillierte Urheberrechts- und Lizenzinformationen finden Sie auf der nächsten Seite.

**Ytterligare information****Svenska**

Extrafunktionen på denna produkt stödjer ljudfilformatet Apple Lossless. För detaljerad information om upphovsrätten och licensen, vänligen se andra sidan av detta blad.

**Información adicional****Español**

La función adicional de este producto admite formato de archivo de audio Apple Lossless. Para obtener información detallada sobre la propiedad intelectual y la licencia, consulte la otra cara de esta página.

**Informazioni aggiuntive****Italiano**

La funzione aggiuntiva del prodotto supporta il formato audio Apple Lossless. Le informazioni dettagliate su copyright e licenza si trovano sul retro di questa pagina.

**Aanvullende informatie****Nederlands**

De aanvullende functie van dit product ondersteunt de Apple Lossless-geluidsbestandsindeling. Raadpleeg de andere kant van deze pagina voor gedetailleerde informatie over de copyright en licentie.

**Дополнительная информация****Русский**

Дополнительная функция данного устройства поддерживает аудиоформат Apple Lossless. Для получения подробной информации об Авторских правах и Лицензиях см. следующую страницу.

**补充信息****中文**

本产品上的附加功能可支持 Apple Lossless 音频文件格式。  
如需关于版权和许可证的详细信息，请参看本页背面上的内容。

## Copyright

## English

Copyright © 2011 Apple Inc. All rights reserved.

Licensed under the Apache License, Version 2.0 (the “License”); you may not use this file except in compliance with the License. You may obtain a copy of the License at

<http://www.apache.org/licenses/LICENSE-2.0>

Unless required by applicable law or agreed to in writing, software distributed under the License is distributed on an "AS IS" BASIS, WITHOUT WARRANTIES OR CONDITIONS OF ANY KIND, either express or implied.

See the License for the specific language governing permissions and limitations under the License.

## Droits d'auteur

## Français

Le texte authentique est en anglais. Cette traduction sert à titre de référence seulement.

Droits d'auteur © 2011 Apple Inc. Tous droits réservés.

Sous licence Apache, Version 2.0 (la «Licence»);  
Le fichier peut être utilisé uniquement selon les termes de la Licence.  
Vous pouvez vous procurer une copie de la Licence sous

<http://www.apache.org/licenses/LICENSE-2.0>

Sauf dans le cas d'obligations légales ou d'accords écrits, le logiciel distribué sous cette Licence est distribué «EN L'ÉTAT», SANS GARANTIE NI CONDITION DE QUELQUE NATURE, explicite ou tacite.  
Voyez la Licence pour les permissions et restrictions liées à la Licence dans votre langue.

<b>Important Notice: Guarantee Information for customers in EEA* and Switzerland</b>	<b>English</b>
<p>For detailed guarantee information about this Yamaha product, and Pan-EEA* and Switzerland warranty service, please either visit the website address below (Printable file is available at our website) or contact the Yamaha representative office for your country. * EEA: European Economic Area</p>	
<b>Remarque importante: informations de garantie pour les clients de l'EEE et la Suisse</b>	<b>Français</b>
<p>Pour des informations plus détaillées sur la garantie de ce produit Yamaha et sur le service de garantie applicable dans l'ensemble de l'EEE ainsi qu'en Suisse, consultez notre site Web à l'adresse ci-dessous (le fichier imprimable est disponible sur notre site Web) ou contactez directement Yamaha dans votre pays de résidence. * EEE : Espace Economique Européen</p>	
<b>Wichtiger Hinweis: Garantie-Information für Kunden in der EWR* und der Schweiz</b>	<b>Deutsch</b>
<p>Für nähere Garantie-Information über dieses Produkt von Yamaha, sowie über den Pan-EWR*- und Schweizer Garantieservice, besuchen Sie bitte entweder die folgend angegebene Internetadresse (eine druckfähige Version befindet sich auch auf unserer Webseite), oder wenden Sie sich an den für Ihr Land zuständigen Yamaha-Vertrieb. *EWR: Europäischer Wirtschaftsraum</p>	
<b>Viktigt: Garantiinformation för kunder i EES-området* och Schweiz</b>	<b>Svenska</b>
<p>För detaljerad information om denna Yamahaprodukt samt garantiservice i hela EES-området* och Schweiz kan du antingen besöka nedanstående webbadress (en utskriftsvänlig fil finns på webbplatsen) eller kontakta Yamahas officiella representant i ditt land. * EES: Europeiska Ekonomiska Samarbetsområdet</p>	
<b>Avviso importante: informazioni sulla garanzia per i clienti residenti nell'EEA* e in Svizzera</b>	<b>Italiano</b>
<p>Per informazioni dettagliate sulla garanzia relativa a questo prodotto Yamaha e l'assistenza in garanzia nei paesi EEA* e in Svizzera, potete consultare il sito Web all'indirizzo riportato di seguito (è disponibile il file in formato stampabile) oppure contattare l'ufficio di rappresentanza locale della Yamaha. * EEA: Area Economica Europea</p>	
<b>Aviso importante: información sobre la garantía para los clientes del EEE* y Suiza</b>	<b>Español</b>
<p>Para una información detallada sobre este producto Yamaha y sobre el soporte de garantía en la zona EEE* y Suiza, visite la dirección web que se incluye más abajo (la versión del archivo para imprimir esta disponible en nuestro sitio web) o póngase en contacto con el representante de Yamaha en su país. * EEE: Espacio Económico Europeo</p>	
<b>Belangrijke mededeling: Garantie-informatie voor klanten in de EER* en Zwitserland</b>	<b>Nederlands</b>
<p>Voor gedetailleerde garantie-informatie over dit Yamaha-product en de garantieservice in heel de EER* en Zwitserland, gaat u naar de onderstaande website (u vindt een afdrukbaar bestand op onze website) of neemt u contact op met de vertegenwoordiging van Yamaha in uw land. * EER: Europese Economische Ruimte</p>	

<http://europe.yamaha.com/warranty/>

