

RX-V659

AV Receiver

Ampli-tuner audio-vidéo

OWNER'S MANUAL
MODE D'EMPLOI
BEDIENUNGSANLEITUNG
BRUKSANVISNING
GEBRUIKSAANWIJZING
ИНСТРУКЦИЯ ПО ЭКСПЛУАТАЦИИ

CAUTION: READ THIS BEFORE OPERATING YOUR UNIT.

- 1 To assure the finest performance, please read this manual carefully. Keep it in a safe place for future reference.
- 2 Install this sound system in a well ventilated, cool, dry, clean place – away from direct sunlight, heat sources, vibration, dust, moisture, and/or cold. Allow ventilation space of at least 30 cm on the top, 20 cm on the left and right, and 20 cm on the back of this unit.
- 3 Locate this unit away from other electrical appliances, motors, or transformers to avoid humming sounds.
- 4 Do not expose this unit to sudden temperature changes from cold to hot, and do not locate this unit in an environment with high humidity (i.e. a room with a humidifier) to prevent condensation inside this unit, which may cause an electrical shock, fire, damage to this unit, and/or personal injury.
- 5 Avoid installing this unit where foreign object may fall onto this unit and/or this unit may be exposed to liquid dripping or splashing. On the top of this unit, do not place:
 - other components, as they may cause damage and/or discoloration on the surface of this unit.
 - burning objects (i.e. candles), as they may cause fire, damage to this unit, and/or personal injury.
 - containers with liquid in them, as they may fall and liquid may cause electrical shock to the user and/or damage to this unit.
- 6 Do not cover this unit with a newspaper, tablecloth, curtain, etc. in order not to obstruct heat radiation. If the temperature inside this unit rises, it may cause fire, damage to this unit, and/or personal injury.
- 7 Do not plug in this unit to a wall outlet until all connections are complete.
- 8 Do not operate this unit upside-down. It may overheat, possibly causing damage.
- 9 Do not use force on switches, knobs and/or cords.
- 10 When disconnecting the power cable from the wall outlet, grasp the plug; do not pull the cord.
- 11 Do not clean this unit with chemical solvents; this might damage the finish. Use a clean, dry cloth.
- 12 Only voltage specified on this unit must be used. Using this unit with a higher voltage than specified is dangerous and may cause fire, damage to this unit, and/or personal injury. YAMAHA will not be held responsible for any damage resulting from use of this unit with a voltage other than specified.
- 13 To prevent damage by lightning, keep the power cable and outdoor antennas disconnected from a wall outlet or this unit during a lightning storm.
- 14 Do not attempt to modify or fix this unit. Contact qualified YAMAHA service personnel when any service is needed. The cabinet should never be opened for any reasons.
- 15 When not planning to use this unit for long periods of time (i.e. vacation), disconnect the AC power plug from the wall outlet.
- 16 Install this unit near the AC wall outlet where the power cable plug can be reached easily.
- 17 Be sure to read the “TROUBLESHOOTING” section on common operating errors before concluding that this unit is faulty.
- 18 Before moving this unit, press MASTER ON/OFF to release it outward to the OFF position to turn off this unit, and then disconnect the power cable from the AC wall outlet.
- 19 **VOLTAGE SELECTOR** (Asia and General models only)
The VOLTAGE SELECTOR on the rear panel of this unit must be set for your local main voltage BEFORE plugging into the AC wall outlet. Voltages are:
Asia model 220/230–240 V AC, 50/60 Hz
General model 110/120/220/230–240 V AC, 50/60 Hz

WARNING

TO REDUCE THE RISK OF FIRE OR ELECTRIC SHOCK, DO NOT EXPOSE THIS UNIT TO RAIN OR MOISTURE.

This unit is not disconnected from the AC power source as long as it is connected to the wall outlet, even if this unit itself is turned off. In this state, this unit is designed to consume a very small quantity of power.

■ For U.K. customers

If the socket outlets in the home are not suitable for the plug supplied with this appliance, it should be cut off and an appropriate 3 pin plug fitted. For details, refer to the instructions described below.

Note

The plug severed from the mains lead must be destroyed, as a plug with bared flexible cord is hazardous if engaged in a live socket outlet.

■ Special Instructions for U.K. Model

IMPORTANT

THE WIRES IN MAINS LEAD ARE COLOURED IN ACCORDANCE WITH THE FOLLOWING CODE:

Blue: NEUTRAL

Brown: LIVE

As the colours of the wires in the mains lead of this apparatus may not correspond with the coloured markings identifying the terminals in your plug, proceed as follows:

The wire which is coloured BLUE must be connected to the terminal which is marked with the letter N or coloured BLACK. The wire which is coloured BROWN must be connected to the terminal which is marked with the letter L or coloured RED.

Making sure that neither core is connected to the earth terminal of the three pin plug.

CONTENTS

INTRODUCTION

FEATURES	2
GETTING STARTED	3
Supplied accessories	3
Installing batteries in the remote control	3
CONTROLS AND FUNCTIONS	4
Front panel.....	4
Remote control.....	6
Front panel display	9
Rear panel	11

PREPARATION

CONNECTIONS	12
Placing speakers.....	12
Connecting speakers	13
Information on jacks and cable plugs	17
Audio and video signal flow.....	18
Connecting a TV.....	19
Connecting a DVD player, a DVD recorder, a VCR or an STB.....	20
Connecting a CD player, an MD player, a tape deck or a turntable.....	23
Connecting a YAMAHA iPod universal dock	24
Connecting an external amplifier.....	25
Connecting a multi-format player or an external decoder	26
Connecting a game console, a video camera or a portable audio player.....	27
Connecting the FM and AM antennas	28
Connecting the power cable.....	29
Setting the speaker impedance.....	30
Turning on and off the power	31
AUTO SETUP	32
Connecting the optimizer microphone.....	32
Using AUTO SETUP	33

BASIC OPERATION

PLAYBACK	38
USING AUDIO FEATURES	40
Using SILENT CINEMA	40
Muting the audio output.....	40
Selecting the night listening mode.....	40
Selecting the input mode	41
Using the sleep timer	41
Adjusting the speaker level.....	42
Selecting the Compressed Music Enhancer mode	43
Selecting the MULTI CH INPUT component.....	44
Enjoying multi-channel sources in 2-channel stereo.....	45
Enjoying unprocessed input sources.....	45
Enjoying pure hi-fi stereo sound.....	45
USING VIDEO FEATURES	46
Displaying the input source information	46
Selecting the OSD mode.....	47
Playing video sources in the background	47

ENJOYING SURROUND SOUND	48
Enjoying multi-channel sources in surround	48
Enjoying 2-channel sources in surround.....	49
Using Virtual CINEMA DSP	50
RECORDING	51
FM/AM TUNING	52
Automatic tuning	52
Manual tuning.....	53
Automatic preset tuning.....	54
Manual preset tuning	55
Selecting preset stations.....	56
Exchanging preset stations	57
RADIO DATA SYSTEM TUNING (U.K. AND EUROPE MODELS ONLY)	59
Selecting the Radio Data System program	59
Using the Radio Data System station network	60
Displaying the Radio Data System information	61

SOUND FIELD PROGRAMS

SOUND FIELD PROGRAMS	63
Selecting sound field programs	63
Sound field program descriptions.....	64
Changing sound field parameter settings.....	66
Sound field program speaker layouts	72

ADVANCED OPERATION

SET MENU	76
Using SET MENU.....	78
1 SOUND MENU.....	79
2 INPUT MENU.....	85
3 OPTION MENU.....	87
ADVANCED SETUP	90
REMOTE CONTROL FEATURES	92
Controlling this unit, a TV, or other components	92
Setting the remote control code	94
Setting library codes	95
Resetting all remote control codes.....	96
USING MULTI-ZONE CONFIGURATION	97
Connecting Zone 2.....	97
Controlling Zone 2.....	99
USING iPod®	101
Setting the remote control code	101
Controlling iPod	101
RESETTING THE SYSTEM	103

ADDITIONAL INFORMATION

TROUBLESHOOTING	104
GLOSSARY	111
Audio information	111
Video information.....	112
Sound field program information	113
SPECIFICATIONS	114

INTRODUCTION

PREPARATION

BASIC
OPERATION

SOUND FIELD
PROGRAMS

ADVANCED
OPERATION

ADDITIONAL
INFORMATION

English

FEATURES

Built-in 7-channel power amplifier

- ◆ Minimum RMS output power (0.06% THD, 20 Hz to 20 kHz, 8 Ω)
Front: 100 W + 100 W
Center: 100 W
Surround: 100 W + 100 W
Surround back: 100 W + 100 W

Sound field programs

- ◆ Proprietary YAMAHA technology for the creation of sound fields
- ◆ Dolby Digital/Dolby Digital EX decoder
- ◆ DTS/DTS-ES Matrix 6.1, Discrete 6.1, DTS Neo:6, DTS 96/24 decoder
- ◆ Dolby Pro Logic/Dolby Pro Logic II/Dolby Pro Logic IIX decoder
- ◆ Virtual CINEMA DSP
- ◆ SILENT CINEMA™

Sophisticated AM/FM tuner

- ◆ 40-station random and direct preset tuning
- ◆ Automatic preset tuning
- ◆ Preset station shifting capability (preset editing)

Radio Data System

(U.K. and Europe models only)

- ◆ Radio Data System tuning capability

iPod controlling capability

- ◆ DOCK terminal to connect a YAMAHA iPod universal dock (such as YDS-10 sold separately), which supports iPod (Click and Wheel), iPod nano, and iPod mini

Notes

-  indicates a tip for your operation.
- Some operations can be performed by using either the buttons on the front panel or the ones on the remote control. In case the button names differ between the front panel and the remote control, the button name on the remote control is given in parentheses.
- This manual is printed prior to production. Design and specifications are subject to change in part as a result of improvements, etc. In case of differences between the manual and product, the product has priority.



Manufactured under license from Dolby Laboratories.

“Dolby”, “Pro Logic”, and the double-D symbol are trademarks of Dolby Laboratories.



Manufactured under license from Digital Theater Systems, Inc. “DTS”, “DTS-ES”, “NEO:6”, and “DTS 96/24” are trademarks of Digital Theater Systems, Inc. Copyright 1996, 2003 Digital Theater Systems, Inc. All right reserved.

Other features

- ◆ YPAO (YAMAHA Parametric Room Acoustic Optimizer) for automatic speaker setup
- ◆ 192-kHz/24-bit D/A converter
- ◆ OSD (on-screen display) menus that allow you to optimize this unit to suit your individual audiovisual system
- ◆ 8 additional input jacks for discrete multi-channel input
- ◆ Pure Direct mode for pure hi-fi stereo sound with analog and PCM sources
- ◆ S-video signal input/output capability
- ◆ Component video input/output capability (3 COMPONENT VIDEO INs and 1 MONITOR OUT)
- ◆ Digital video signal conversion (composite video ↔ S-video → component video) capability for monitor out
- ◆ Optical and coaxial digital audio signal jacks
- ◆ Sleep timer
- ◆ Cinema and music night listening modes
- ◆ Remote control with preset remote control codes, backlighting input selector buttons, and an iPod (stationed in a YAMAHA iPod universal dock connected to the DOCK terminal) controlling capability
- ◆ Zone 2 custom installation facility
- ◆ Zone switching capability between the main zone and Zone 2 using ZONE CONTROL
- ◆ Compressed Music Enhancer mode to improve the sound quality of compression artifacts (such as the MP3 format) to that of a high-quality stereo

iPod®

“iPod” is a trademark of Apple Computer, Inc., registered in the U.S. and other countries.

SILENT™ CINEMA

“SILENT CINEMA” is a trademark of YAMAHA CORPORATION.

GETTING STARTED

Supplied accessories

Check that you received all of the following parts.

Remote control

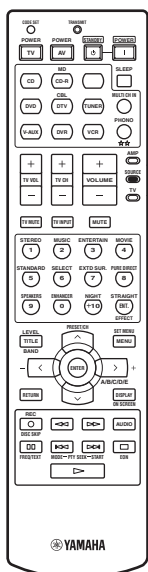

Batteries (2)
(AA, R6, UM-3)

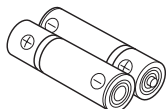

AM loop antenna
(except for U.K. model)



Optimizer microphone

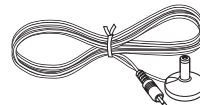

Indoor FM antenna
(U.S.A., Canada, China, Asia
and General models)

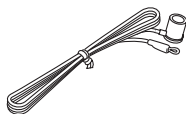

Indoor FM antenna
(Europe, Australia and
Korea models)

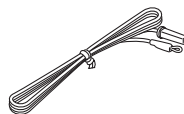

Installing batteries in the remote control

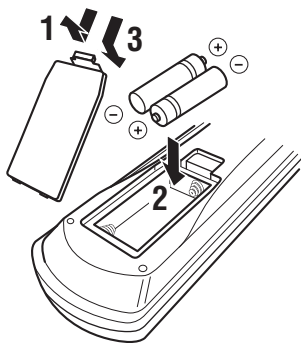

1 Take off the battery compartment cover.

2 Insert the two supplied batteries (AA, R6, UM-3) according to the polarity markings (+ and -) on the inside of the battery compartment.

3 Snap the battery compartment cover back into place.

Notes

- Change all of the batteries if you notice the following conditions:
 - the operation range of the remote control decreases.
 - the TRANSMIT indicator does not flash or its light becomes dim.
- Do not use an old battery together with a new one.
- Do not use different types of batteries (such as alkaline and manganese batteries) together. Read the packaging carefully as these different types of batteries may have the same shape and color.
- If the batteries have leaked, dispose of them immediately. Avoid touching the leaked material or letting it come into contact with clothing, etc. Clean the battery compartment thoroughly before installing new batteries.
- Do not throw away batteries with general house waste; dispose of them correctly in accordance with your local regulations.
- If the remote control is without batteries for more than 2 minutes, or if exhausted batteries remain in the remote control, the contents of the memory may be cleared. When the memory is cleared, insert new batteries, set up the remote control code and program any acquired functions that may have been cleared.

CONTROLS AND FUNCTIONS

Front panel

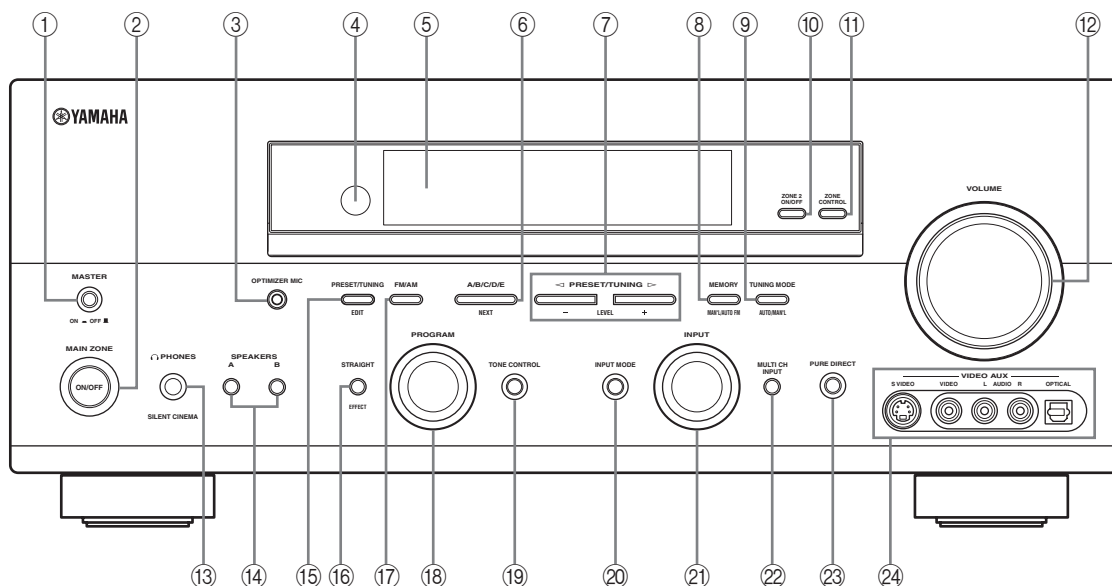

① MASTER ON/OFF

Turns on or off this unit (see page 31).

② MAIN ZONE ON/OFF

Turns on the main zone or sets it to the standby mode (see page 31).

Notes

- In the standby mode, this unit consumes a small amount of power in order to receive infrared signals from the remote control.
- When you turn on this unit, there will be a 4 to 5-second delay before this unit can reproduce sound.
- This button is operational only when MASTER ON/OFF is pressed inward to the ON position.

③ OPTIMIZER MIC jack

Use to connect and input audio signals from the supplied optimizer microphone in the “AUTO SETUP” procedure (see page 32).

④ Remote control sensor

Receives signals from the remote control (see page 8).

⑤ Front panel display

Shows information about the operational status of this unit (see page 9).

⑥ A/B/C/D/E, NEXT

- Selects one of the 5 preset station groups (A to E) when “TUNER” is selected as the input source (see page 52).
- Selects the speaker channel whose output level you want to adjust when “TUNER” is not selected as the input source (see page 42).

⑦ PRESET/TUNING </>, LEVEL +/-

- Selects one of the 8 preset station numbers (1 to 8) when “TUNER” is selected as the input source. The colon (:) is displayed in the front panel display (see page 52).
- Selects the tuning frequency when “TUNER” is selected as the input source. The colon (:) is not displayed in the front panel display (see page 52).
- Adjusts the level of the speaker channel selected using NEXT when “TUNER” is not selected as the input source (see page 42).

⑧ MEMORY (MAN'L/AUTO FM)

Stores a preset station in the memory. Hold down this button for more than 3 seconds to start automatic preset tuning (see page 54).

⑨ TUNING MODE (AUTO/MAN'L)

Switches between automatic tuning (the AUTO indicator is turned on) and manual tuning (the AUTO indicator is turned off) (see page 52).

⑩ ZONE 2 ON/OFF

Turns on Zone 2 or sets it to the standby mode (see page 99).

Note

This button is operational only when MASTER ON/OFF is pressed inward to the ON position.

⑪ ZONE CONTROL

Switches the zone you want to control between the main zone and Zone 2 (see page 99).



When Zone 2 is selected, the ZONE2 indicator flashes in the front panel display for approximately 5 seconds. While the indicator is flashing, perform the desired operation.

⑫ VOLUME

Controls the output level of all audio channels.



This does not affect the AUDIO OUT (REC) level.

⑬ PHONES (SILENT CINEMA) jack

Outputs audio signals for private listening with headphones (see page 40).

Notes

- When you connect headphones, no signals are output at the speaker terminals.
- All Dolby Digital and DTS audio signals are mixed down to the left and right headphone channels.

⑭ SPEAKERS A/B

Turns on or off the set of front speakers connected to the FRONT A and/or B terminals on the rear panel each time the corresponding button is pressed.

⑮ PRESET/TUNING, EDIT

- Switches the function of PRESET/TUNING ◀ / ▶ between selecting preset station numbers and selecting the tuning frequency.
- Edits the assignments of preset stations (see page 57).

⑯ STRAIGHT (EFFECT)

Turns the sound field programs off or on. When the "STRAIGHT" mode is selected, 2-channel or multi-channel input signals are output directly from their respective speakers without effect processing (see page 45).

⑰ FM/AM

Switches the reception band between FM and AM when "TUNER" is selected as the input source (see page 52).

⑱ PROGRAM selector

Selects sound field programs or adjusts the bass/treble balance in conjunction with TONE CONTROL (see page 39).

⑲ TONE CONTROL

Adjusts the bass/treble balance of the front left and right, center, presence left and right and subwoofer channels in conjunction with the PROGRAM selector (see page 39).

⑳ INPUT MODE

Selects either digital or analog input signals exclusively or sets this unit to automatically detect the type of input signals and select the corresponding input signals when one component is connected via both digital and analog connections (see page 41).

㉑ INPUT selector

Selects the desired input source.

㉒ MULTI CH INPUT

Selects the component connected to the MULTI CH INPUT jacks as the input source (see page 44).

Note

The input source connected to the MULTI CH INPUT jacks takes priority over the source selected with the INPUT selector on the front panel (or the input selector buttons on the remote control).

㉓ PURE DIRECT

Turns on or off the Pure Direct mode (see page 45).

㉔ VIDEO AUX jacks

Input audio and video signals from a portable external source such as a game console or a video camera (see page 27).



To reproduce the source signals input at these jacks, select "V-AUX" as the input source.

Note

The audio signals input at the DOCK terminal on the rear panel take priority over the ones input at the VIDEO AUX jacks.

Remote control

This section describes the function of each control on the remote control used to control this unit. To operate other components, see “REMOTE CONTROL FEATURES” on page 92.

Note

The operation mode of the remote control buttons in the shaded area below depends on the component selector switch position. Set the component selector switch to AMP to control this unit. To control the TUNER functions, set the component selector switch to SOURCE and then press TUNER to select “TUNER” as the input source.

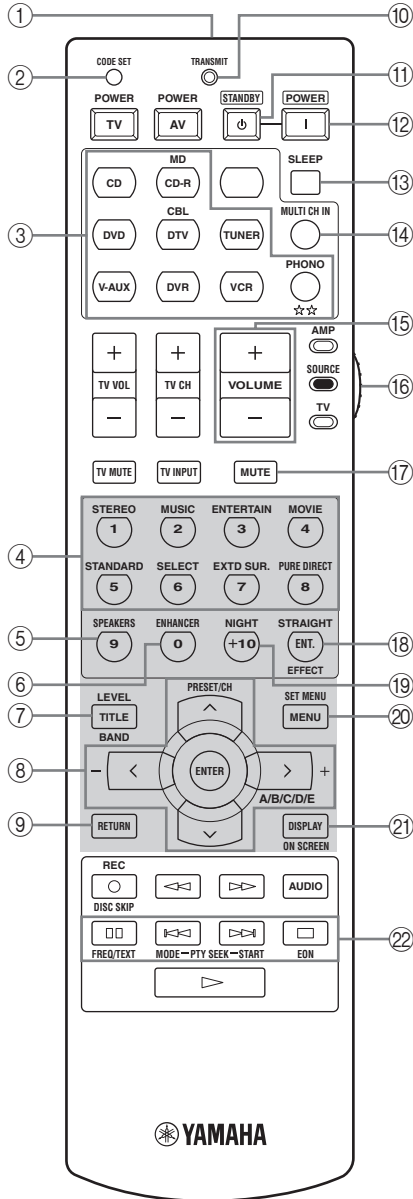

■ Controlling this unit

Set the component selector switch to AMP to control this unit.

① Infrared window

Outputs infrared control signals. Aim this window at the component you want to operate (see page 8).

② CODE SET

Use to set up remote control codes (see page 94).

③ Input selector buttons

Select the input source you want to control.

Note

The corresponding input selector button for the currently selected input source lights up for approximately 5 seconds after you press any buttons on the remote control, showing which source component is currently being operated.

④ Sound field program selector buttons

Select sound field programs (see page 63).

- Use SELECT to play back 2-channel sources in surround (see page 49).
- Use EXT D SUR. to switch between 5.1 and 6.1/7.1-channel playback of multi-channel sources (see page 48).
- Use PURE DIRECT to turn on or off the Pure Direct mode (see page 45).

⑤ SPEAKERS

Turns on or off the set of front speakers connected to the FRONT A and/or B terminals on the rear panel. Press this button repeatedly to toggle as follows:

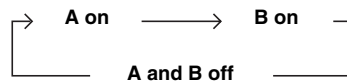

⑥ ENHANCER

Turns on or off the Compressed Music Enhancer mode (see page 43).

⑦ LEVEL

Selects the speaker channel to be adjusted and sets the output level (see page 42).

⑧ Cursor buttons $\wedge/\vee/\>$, ENTER

Select and adjust the sound field program parameters or the “SET MENU” parameters.

⑨ RETURN

Returns to the previous menu level when adjusting the “SET MENU” parameters.

⑩ TRANSMIT indicator

Flashes while the remote control is sending infrared signals.

⑪ STANDBY

Sets this unit to the standby mode (see page 31).

Note

This button is operational only when MASTER ON/OFF on the front panel is pressed inward to the ON position.

⑫ POWER

Turns on this unit (see page 31).

Note

This button is operational only when MASTER ON/OFF on the front panel is pressed inward to the ON position.

⑬ SLEEP

Sets the sleep timer (see page 41).

⑭ MULTI CH IN

Selects the component connected to the MULTI CH INPUT jacks as the input source when using an external decoder, etc. (see page 44).

⑮ VOLUME +/-

Increases or decreases the volume level.

⑯ Component selector switch

Selects the operation mode of the remote control buttons in the shaded area.

AMP

Operates this unit.

SOURCE

Operates the component selected with an input selector button (see page 93).

TV

Operates the TV assigned to either DTV/CBL or PHONO (see page 92).

Notes

- To set the remote control codes for other components, see page 94.
- When you set the remote control codes for both DTV/CBL and PHONO (see page 94), priority is given to the one set for DTV/CBL.

⑰ MUTE

Mutes the audio output. Press again to restore the audio output to the previous volume level (see page 40).

⑱ STRAIGHT (EFFECT)

Turns the sound field programs off or on. When the “STRAIGHT” mode is selected, 2-channel or multi-channel input signals are output directly from their respective speakers without effect processing (see page 45).

⑲ NIGHT

Turns on or off the night listening modes (see page 40).

⑳ SET MENU

Enters “SET MENU” (see page 78).

㉑ ON SCREEN

Selects the on-screen display (OSD) mode for your video monitor (see page 47).

㉒ Radio Data System tuning buttons (U.K. and Europe models only)**FREQ/TEXT**

Switches the Radio Data System display between the PS mode, PTY mode, RT mode, CT mode (if the station offers the corresponding data services) and the frequency display (see page 61).

PTY SEEK MODE

Sets this unit to the PTY SEEK mode (see page 59).

PTY SEEK START

Starts searching for a station once the desired program type is selected in the PTY SEEK mode (see page 59).

EON

Selects a program type (NEWS, AFFAIRS, INFO, or SPORT) for automatic tuning (see page 60).

■ Controlling the TUNER functions

Set the component selector switch to SOURCE and then press TUNER to select “TUNER” as the input source.

④ Numeric buttons

Use numbers 1 through 8 to select preset stations.

⑦ BAND

Switches the reception band between FM and AM (see page 52).

⑧ Cursor buttons $\wedge / \vee / \langle / \rangle$

Press \langle / \rangle to select a preset station group (A to E) and \wedge / \vee to select a preset station number (1 to 8) (see page 56).

■ Using the remote control

The remote control transmits a directional infrared ray. Be sure to aim the remote control directly at the remote control sensor on this unit during operation.

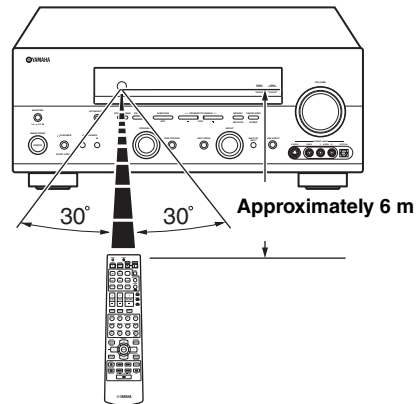

Notes

- Do not spill water or other liquids on the remote control.
- Do not drop the remote control.
- Do not leave or store the remote control in the following types of conditions:
 - places of high humidity, such as near a bath
 - places of high temperatures, such as near a heater or stove
 - places of extremely low temperatures
 - dusty places

Front panel display

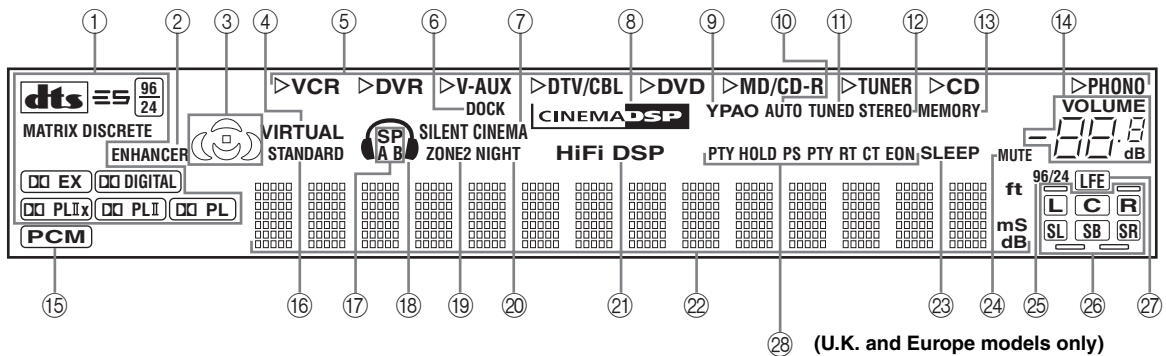

① Decoder indicators

The respective indicator lights up when any of the decoders of this unit function.

② ENHANCER indicator

Lights up when the Compressed Music Enhancer mode is turned on (see page 43).

③ Sound field indicators

Light up to indicate the active DSP sound fields.

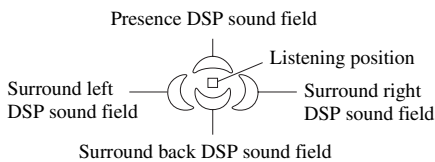

④ VIRTUAL indicator

Lights up when Virtual CINEMA DSP is active (see page 50).

⑤ Input source indicators

The corresponding cursor lights up to show the currently selected input source.

⑥ DOCK indicator

Lights up when you station your iPod in a YAMAHA iPod universal dock (such as YDS-10 sold separately) connected to the DOCK terminal of this unit (see page 24).

⑦ SILENT CINEMA indicator

Lights up when headphones are connected and a sound field program is selected (see page 40).

⑧ CINEMA DSP indicator

Lights up when you select a CINEMA DSP sound field program (see page 64).

⑨ YPAO indicator

Lights up when you run "AUTO SETUP" and when the speaker settings set in "AUTO SETUP" are used without any modifications (see page 32).

⑩ AUTO indicator

Lights up when this unit is in the automatic tuning mode (see page 52).

⑪ TUNED indicator

Lights up when this unit is tuned into a station (see page 52).

⑫ STEREO indicator

Lights up when this unit is receiving a strong signal for an FM stereo broadcast while the AUTO indicator is lit (see page 52).

⑬ MEMORY indicator

Flashes to show that a station can be stored (see page 54).

⑭ VOLUME level indicator

Indicates the current volume level.

⑮ PCM indicator

Lights up when this unit is reproducing PCM (Pulse Code Modulation) digital audio signals.

16 STANDARD indicator

Lights up when the “SUR. STANDARD” or “SUR. ENHANCED” program is selected (see page 49).

17 SP A B indicators

Light up according to the set of front speakers selected.

18 Headphones indicator

Lights up when headphones are connected (see page 40).

19 ZONE2 indicator

Lights up when Zone 2 is turned on (see page 99).

20 NIGHT indicator

Lights up when you select a night listening mode (see page 40).

21 HiFi DSP indicator

Lights up when you select a HiFi DSP sound field program (see page 64).

22 Multi-information display

Shows the name of the current sound field program and other information when adjusting or changing settings.

23 SLEEP indicator

Lights up while the sleep timer is on (see page 41).

24 MUTE indicator

Flashes while the MUTE function is on (see page 40).

25 96/24 indicator

Lights up when a DTS 96/24 signal is input to this unit.

26 Input channel and speaker indicators

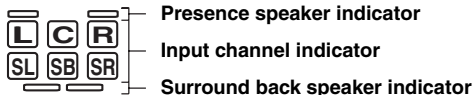

Input channel indicators

Indicate the channel components of the current digital input signal.

Presence and surround back speaker indicators

Light up according to the number of presence and surround back speakers set for “PRESENCE SP” (see page 80) and “SUR. B L/R SP” (see page 80) in “SOUND MENU” when “TEST” in “SOUND MENU” is set to “ON” (see page 83).



You can make settings for the presence and surround back speakers automatically by running “AUTO SETUP” (see page 32) or manually by adjusting settings for “PRESENCE SP” (see page 80) and “SUR. B L/R SP” (see page 80) in “SOUND MENU”.

27 LFE indicator

Lights up when the input signal contains the LFE signal.

28 Radio Data System indicators (U.K. and Europe models only)

Lights up when the Radio Data System data is being received.

EON

Lights up when the EON data service is being received.

PTY HOLD

Lights up while searching for the Radio Data System stations in the PTY SEEK mode.

Rear panel

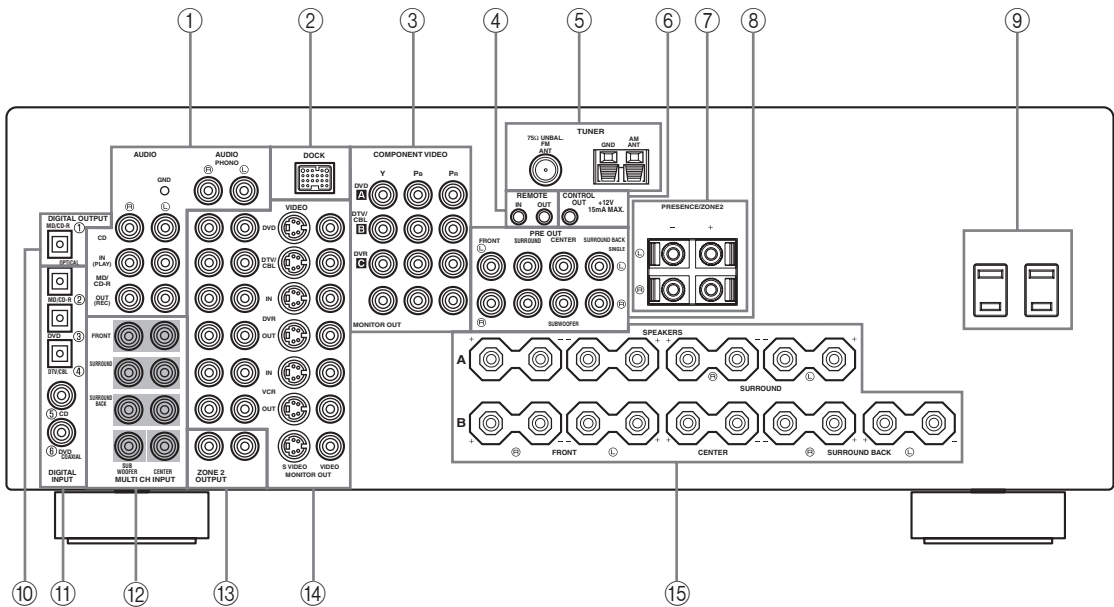

① **Audio component jacks**

See page 23 for connection information.

② **DOCK terminal**

Use to connect a YAMAHA iPod universal dock (such as YDS-10 sold separately) where your iPod can be stationed.

See page 24 for connection information.

③ **COMPONENT VIDEO jacks**

See pages 19 and 20 for connection information.

④ **REMOTE jacks**

See page 97 for details.

⑤ **Antenna terminals**

See page 28 for connection information.

⑥ **CONTROL OUT jack**

This is a control expansion terminal for custom installation.

⑦ **PRESENCE/ZONE2 speaker terminals**

See page 15 for connection information.

⑧ **PRE OUT jacks**

See page 25 for connection information.

⑨ **AC OUTLET(S)**

Use to supply power to your other audiovisual components.

See page 29 for details.

⑩ **DIGITAL OUTPUT jack**

See page 23 for connection information.

⑪ **DIGITAL INPUT jacks**

See page 20 for connection information.

⑫ **MULTI CH INPUT jacks**

See page 26 for connection information.

⑬ **ZONE 2 OUTPUT jacks**

See page 97 for connection information.

Note

These jacks output analog signals only.

⑭ **Video component jacks**

See pages 19 and 20 for connection information.

⑮ **Speaker terminals**

See page 13 for connection information.

■ **VOLTAGE SELECTOR (Asia and General models only)**

See page 29 for details.

CONNECTIONS

Placing speakers

The speaker layout below shows the standard ITU-R* speaker setting. You can use it to enjoy CINEMA DSP and multi-channel audio sources.

* ITU-R is the radio communication sector of the ITU (International Telecommunication Union).

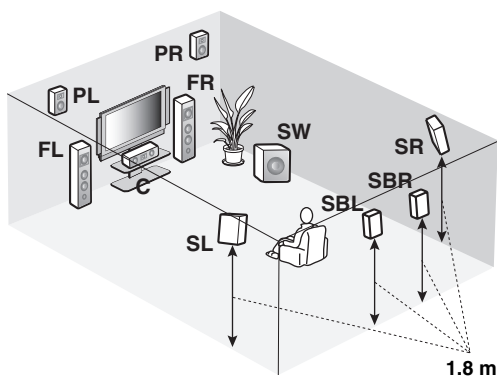
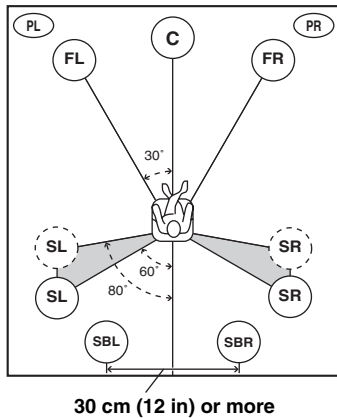

Front left and right speakers (FL and FR)

The front speakers are used for the main source sound plus effect sounds. Place these speakers at an equal distance from the ideal listening position. The distance of each speaker from each side of the video monitor should be the same.

Center speaker (C)

The center speaker is for the center channel sounds (dialog, vocals, etc.). If for some reason it is not practical to use a center speaker, you can do without it. Best results, however, are obtained with the full system. Place the center speaker centrally between the front speakers and as close to the monitor as possible, such as directly over or under it.

Surround left and right speakers (SL and SR)

The surround speakers are used for effect and surround sounds. Place these speakers behind your listening position, facing slightly inwards, about 1.8 m above the floor.

Surround back left and right speakers (SBL and SBR)

The surround back speakers supplement the surround speakers and provides more realistic front-to-back transitions. Place these speakers directly behind the listening position and at the same height as the surround speakers. They should be positioned at least 30 cm apart. Ideally, they should be positioned at the same width as that of the front speakers.

Presence left and right speakers (PL and PR)

The presence speakers supplement the sound from the front speakers with extra ambient effects produced by CINEMA DSP (see page 64). These effects include sounds that filmmakers intent to locate a little farther back behind the screen in order to create more theater-like ambience. Place these speakers at the front of the room about 0.5 – 1 m outside the front speakers, facing slightly inward, and about 1.8 m above the floor.

Subwoofer (SW)

The use of a subwoofer with a built-in amplifier, such as the YAMAHA Active Servo Processing Subwoofer System, is effective not only for reinforcing bass frequencies from any or all channels, but also for hi-fi stereo sound reproduction of the LFE (low-frequency effect) channel included in Dolby Digital and DTS sources. The position of the subwoofer is not so critical, because low bass sounds are not highly directional. But it is better to place the subwoofer near the front speakers. Turn it slightly toward the center of the room to reduce wall reflections.

Connecting speakers

Be sure to connect the left channel (L), right channel (R), “+” (red) and “-” (black) properly. If the connections are faulty, no sound will be heard from the speakers, and if the polarity of the speaker connections is incorrect, the sound will be unnatural and lack bass.

CAUTION

- Before connecting the speakers, make sure that this unit is turned off (see page 31).
- Do not let the bare speaker wires touch each other or do not let them touch any metal part of this unit. This could damage this unit and/or speakers.
- Use magnetically shielded speakers. If this type of speakers still creates the interference with the monitor, place the speakers away from the monitor.
- If you are to use 4 or 6 ohm speakers, be sure to set “SP IMP.” to “6ΩMIN” before using this unit (see page 30).

Notes

- A speaker cord is actually a pair of insulated cables running side by side. Cables are colored or shaped differently, perhaps with a stripe, groove or ridge. Connect the striped (grooved, etc.) cable to the “+” (red) terminals of this unit and your speaker. Connect the plain cable to the “-” (black) terminals.
- The low-frequency signals of other speakers set to “SML” (or “SMALL”) or to “NONE” in “SPEAKER SET” (see pages 79 and 80) are directed to the speakers selected in “LFE/BASS OUT” (see page 81).
- You can use the PRESENCE/ZONE2 terminals to connect the Zone 2 speakers (see page 98).

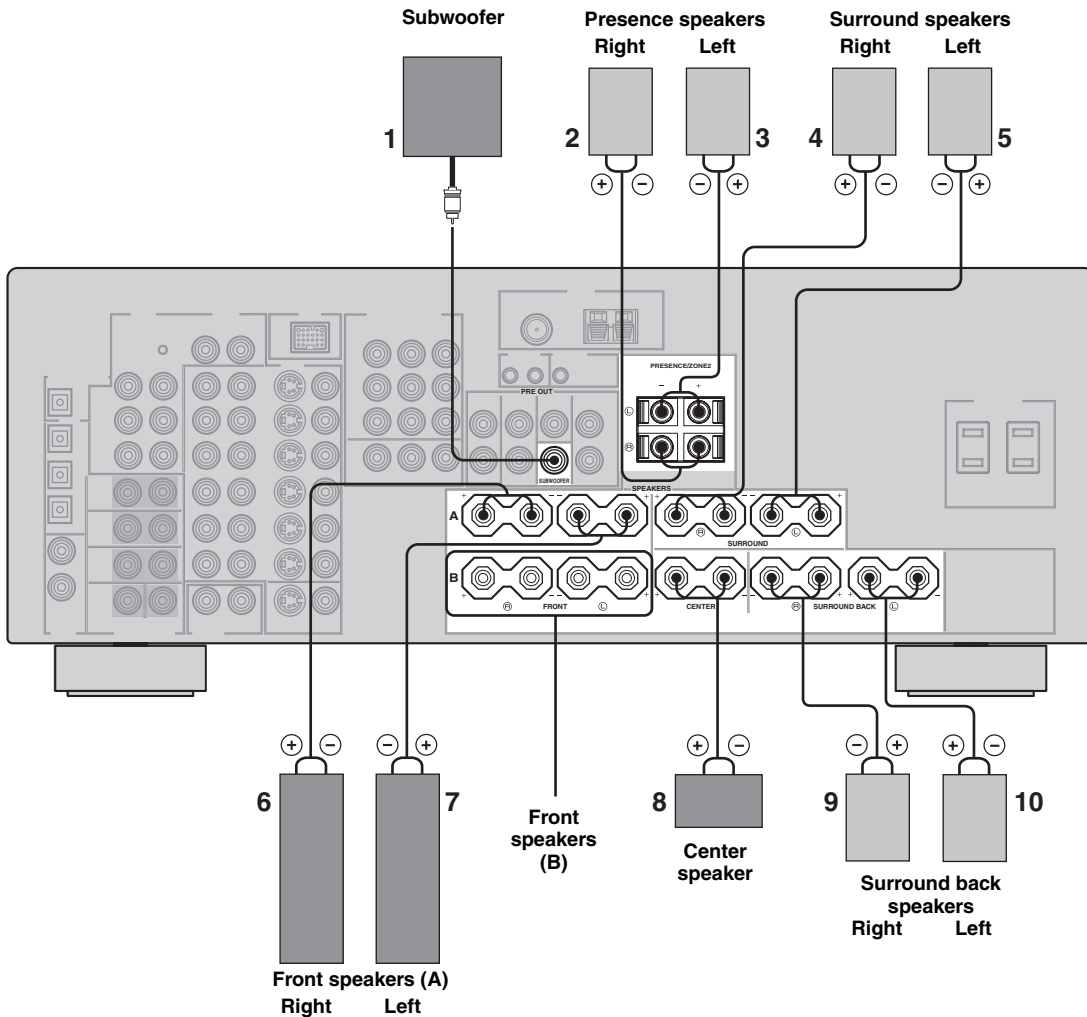

FRONT terminals

Connect one or two front speaker systems (6, 7) to these terminals. If you use only one front speaker system, connect it to the FRONT A or B terminal.

CENTER terminals

Connect a center speaker (8) to these terminals.

SURROUND terminals

Connect surround speakers (4, 5) to these terminals.

SURROUND BACK terminals

Connect a surround back speakers (9, 10) to these terminals.

PRESENCE/ZONE2 terminals

Connect presence speakers (2, 3) to these terminals.

SUBWOOFER jack

Connect a subwoofer with a built-in amplifier (1) (such as the YAMAHA Active Servo Processing Subwoofer System) to this jack.

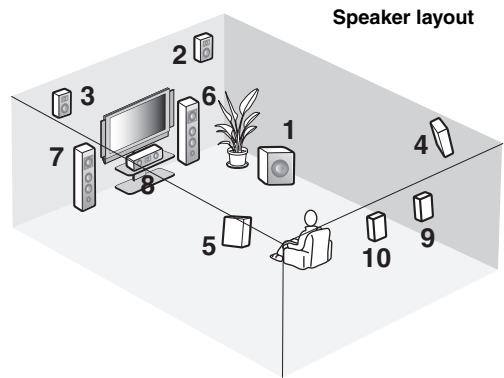

■ Connecting the speaker cable

- 1 Remove approximately 10 mm of insulation from the end of each speaker cable and then twist the exposed wires of the cable together to prevent short circuits.

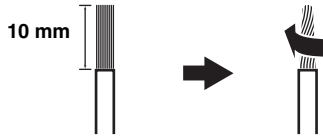

- 2 Loosen the knob.

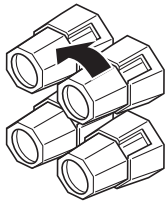

Red: positive (+)
Black: negative (-)

- 3 Insert one bare wire into the hole on the side of each terminal.

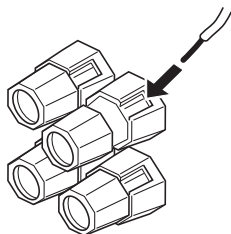

Red: positive (+)
Black: negative (-)

- 4 Tighten the knob to secure the wire.

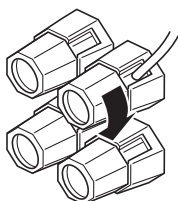

Red: positive (+)
Black: negative (-)

■ Connecting to the PRESENCE/ZONE2 speaker terminals

Connect presence speakers to these terminals.



You can also use these terminals to connect the Zone 2 speakers (see page 97).

- 1 Open the tab.

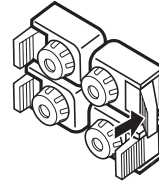

- 2 Insert one bare wire into the hole on the side of each terminal.

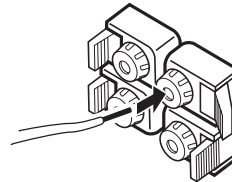

- 3 Close the tab to secure the wire.

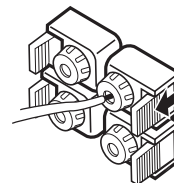

■ **Connecting the banana plug
(except U.K., Europe and Asia models)**

The banana plug is a single-pole electrical connector widely used to terminate speaker cables.

Banana plug

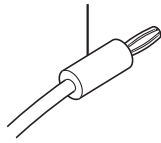

You can also use the banana plug with the PRESENCE/ZONE2 speaker terminals. Open the tab and then insert one banana plug into the hole on the side of each terminal. Do not close the tab after connecting the banana plug.

1 Tighten the knob.

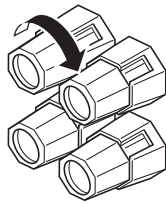

2 Insert the banana plug connector into the end of the corresponding terminal.

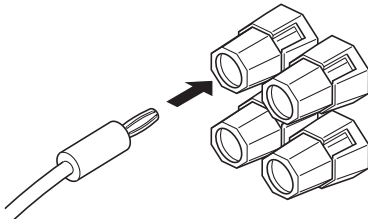

Information on jacks and cable plugs

Note

You can use the digital jacks to input PCM, Dolby Digital and DTS bitstreams. When you connect components to both the COAXIAL and OPTICAL jacks, priority is given to the signals input at the COAXIAL jack. All digital input jacks are compatible with 96-kHz sampling digital signals.

Audio jacks and cable plugs

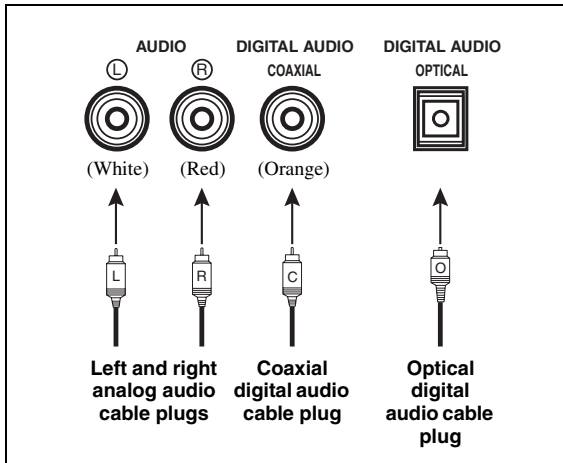

Video jacks and cable plugs

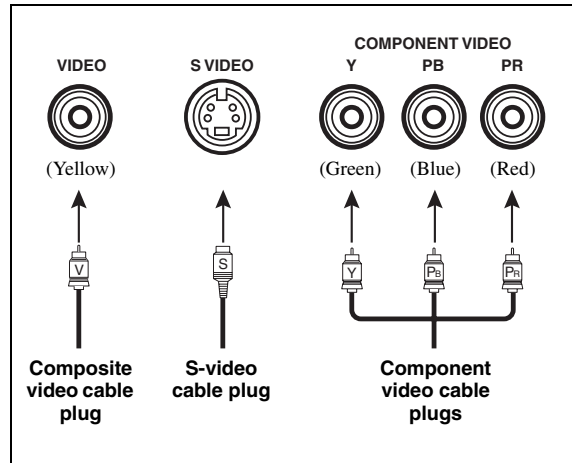

Audio jacks

This unit has three types of audio jacks. Connection depends on the availability of audio jacks on your other components.

AUDIO jacks

For conventional analog audio signals transmitted via left and right analog audio cables. Connect red plugs to the right jacks and white plugs to the left jacks.

DIGITAL AUDIO COAXIAL jacks

For digital audio signals transmitted via coaxial digital audio cables.

DIGITAL AUDIO OPTICAL jacks

For digital audio signals transmitted via optical digital audio cables.

Note

Pull out the cap from the optical jack before you connect the fiber optic cable. Do not discard the cap. When you are not using the optical jack, be sure to put the cap back in place. This cap protects the jack from dust.

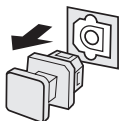

Video jacks

This unit has three types of video jacks. Connection depends on the availability of input jacks on your video monitor. When "VIDEO CONV." is set to "ON" (see page 87), the video signals input at the VIDEO and S VIDEO jacks are converted and output at the VIDEO, S VIDEO and COMPONENT VIDEO jacks interchangeably.

VIDEO jacks

For conventional composite video signals transmitted via composite video cables.

S VIDEO jacks

For S-video signals, separated into the luminance (Y) and chrominance (C) video signals transmitted on separate wires of S-video cables.

COMPONENT VIDEO jacks

For component video signals, separated into the luminance (Y) and chrominance (PB, PR) video signals transmitted on separate wires of component video cables.

Audio and video signal flow

■ Audio signal flow for AUDIO OUT (REC)

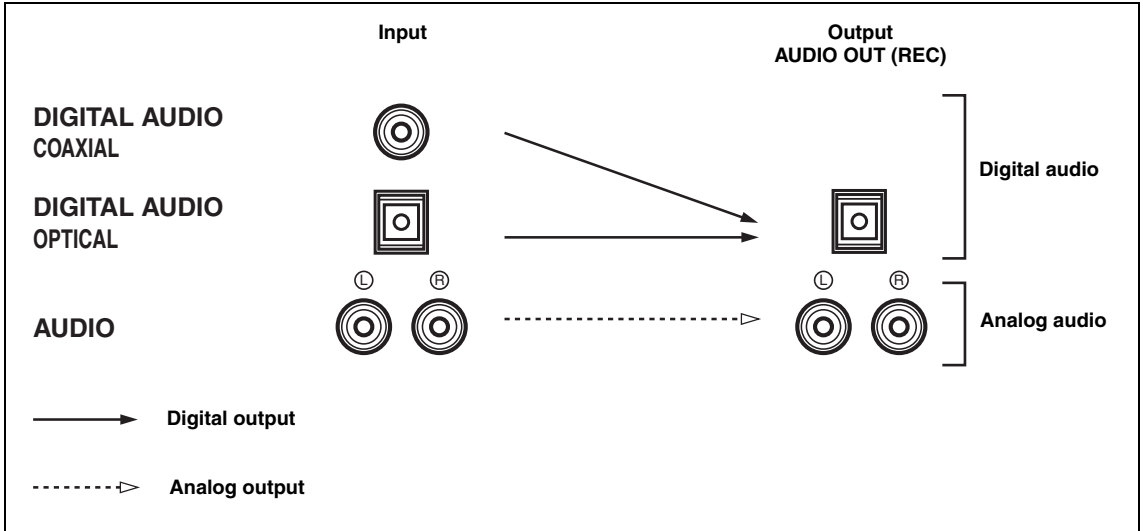

Note

This unit handles digital and analog signals independently. Thus, audio signals input at the analog jacks are output only at the analog AUDIO OUT (REC) jacks. Likewise, audio signals input at the DIGITAL INPUT (OPTICAL or COAXIAL) jacks are output only at the DIGITAL OUTPUT jack.

■ Video signal flow for MONITOR OUT

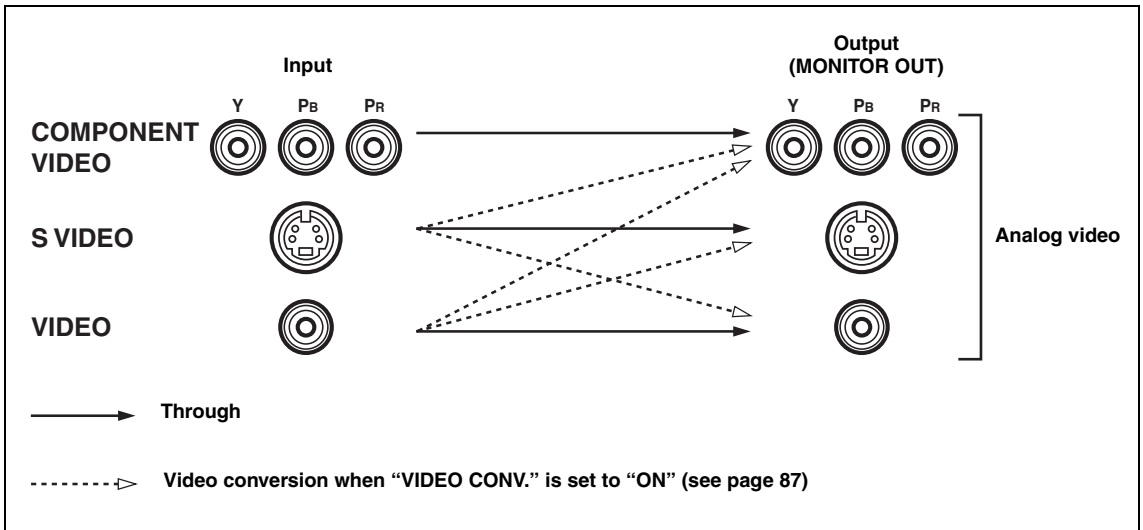

Note

When video signals are input at the COMPONENT VIDEO, S VIDEO and VIDEO jacks, the priority order of the input signals is as follows where the video signals input at the COMPONENT VIDEO jacks have the top priority:
COMPONENT VIDEO > S VIDEO > VIDEO

Connecting a TV

Connect your TV to the VIDEO MONITOR OUT jack, the S VIDEO MONITOR OUT jack or the COMPONENT VIDEO MONITOR OUT jacks of this unit.

CAUTION

Do not connect this unit or other components to the AC power supply until all connections between components are complete.

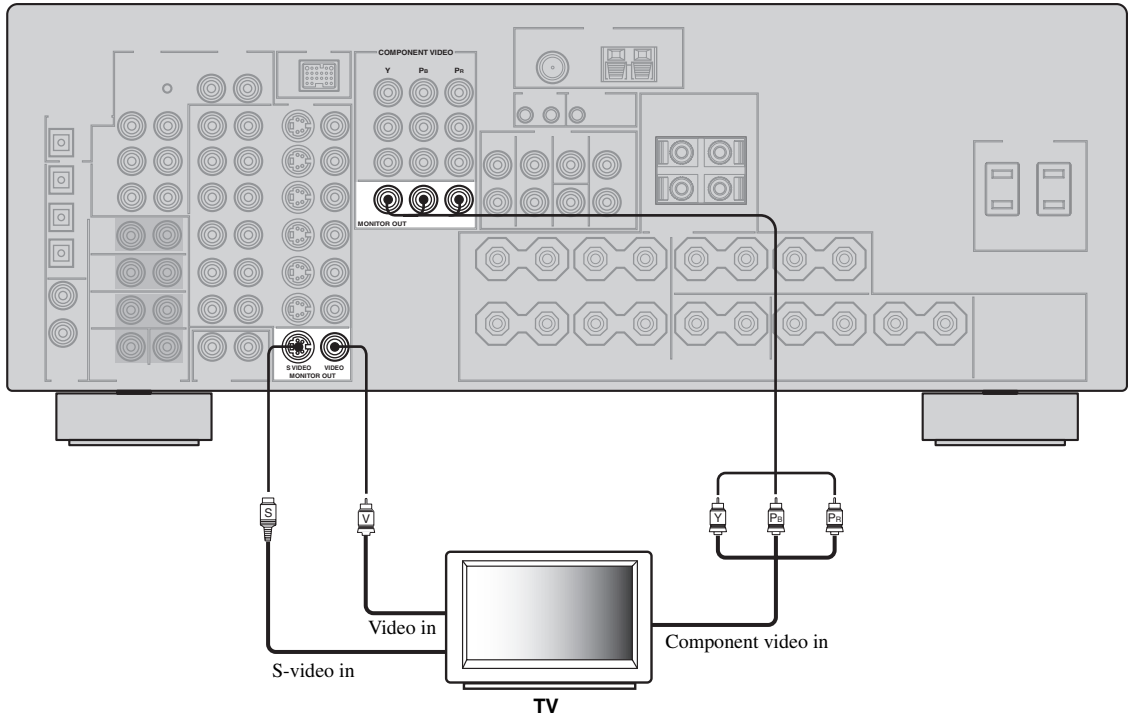

Connecting a DVD player, a DVD recorder, a VCR or an STB

Connect your DVD player, DVD recorder, VCR or STB (set-top box) using the same type of video connections as those made for your TV (see page 19). The cable TV receiver and the satellite receiver are examples of the STB.

CAUTION

Do not connect this unit or other components to the AC power supply until all connections between components are complete.

Notes

- When “VIDEO CONV.” is set to “OFF” (see page 87), be sure to make the same type of video connections as those made for your TV (see page 19). For example, if you connected your TV to the VIDEO MONITOR OUT jack of this unit, connect your other components to the VIDEO jacks.
- When “VIDEO CONV.” is set to “ON” (see page 87), the converted video signals are output only at the MONITOR OUT jacks. When recording a source, you must make the same type of video connections between each component.
- To make a digital connection to a component other than the default component assigned to each DIGITAL INPUT or DIGITAL OUTPUT jack, select the corresponding setting for “OPTICAL OUT”, “OPTICAL IN”, or “COAXIAL IN” in “I/O ASSIGNMENT” (see page 85).
- If you connect your DVD player to both the DIGITAL INPUT (OPTICAL) and the DIGITAL INPUT (COAXIAL) jacks, priority is given to the signals input at the DIGITAL INPUT (COAXIAL) jack.

■ Connecting a DVD player

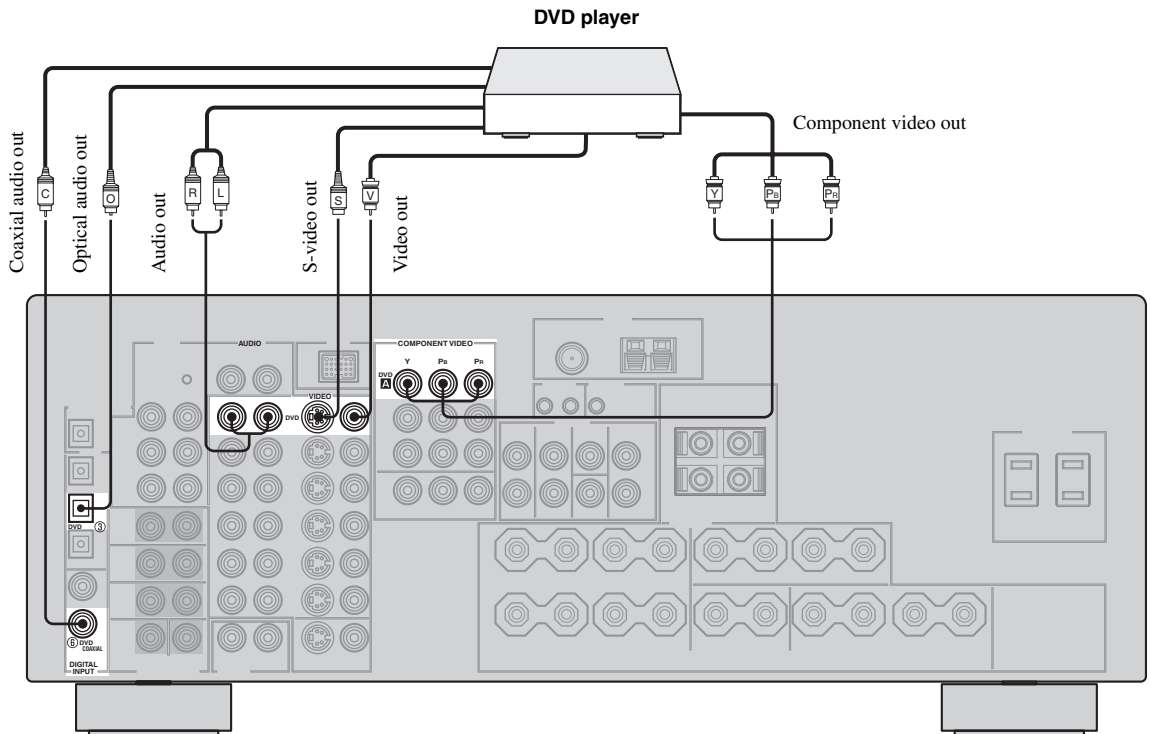

■ Connecting a DVD recorder

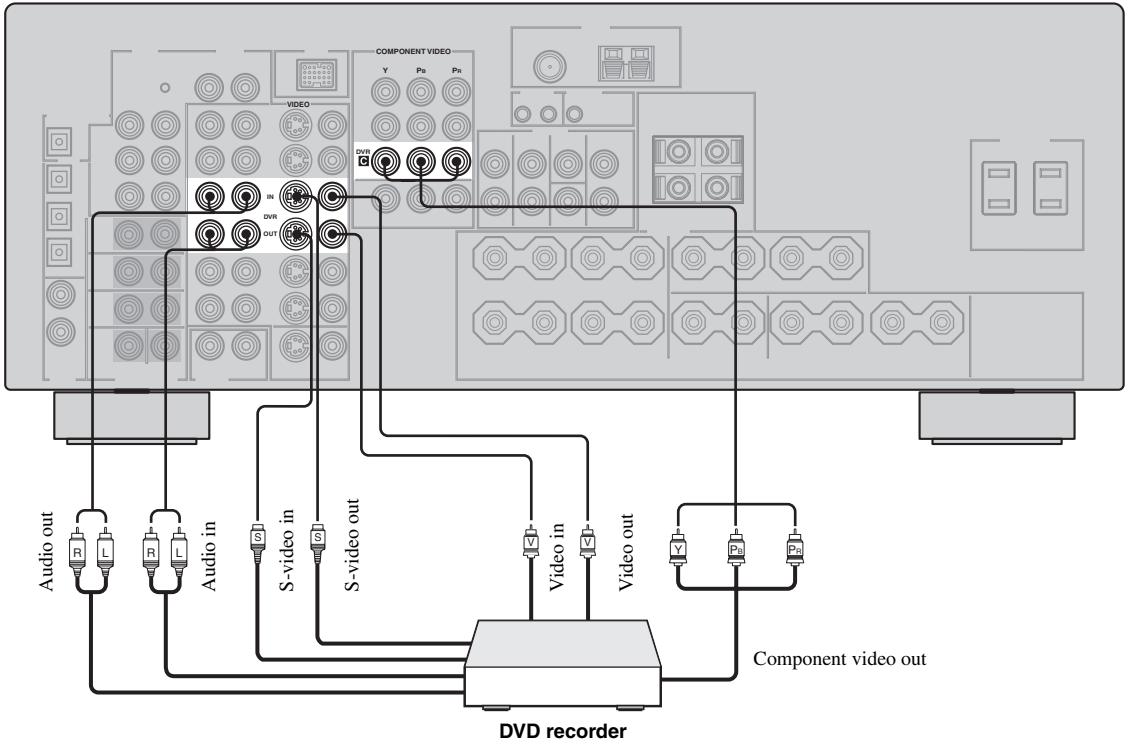

PREPARATION

■ Connecting a VCR

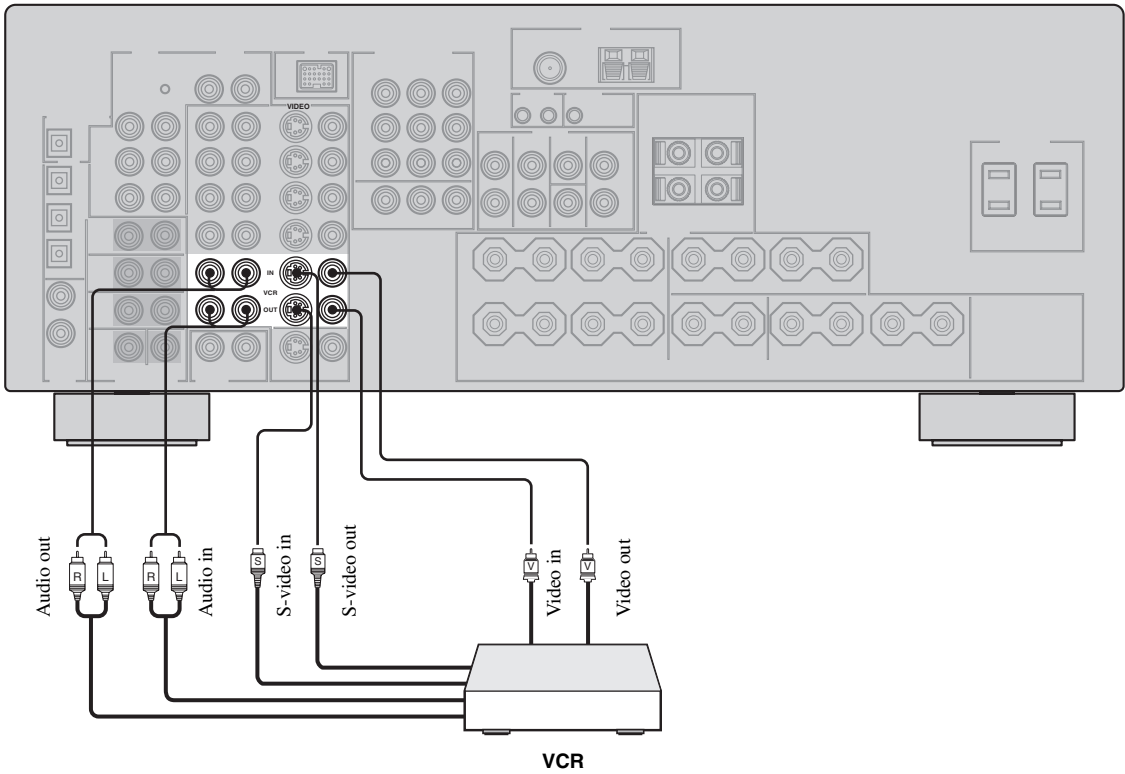

English

■ Connecting an STB

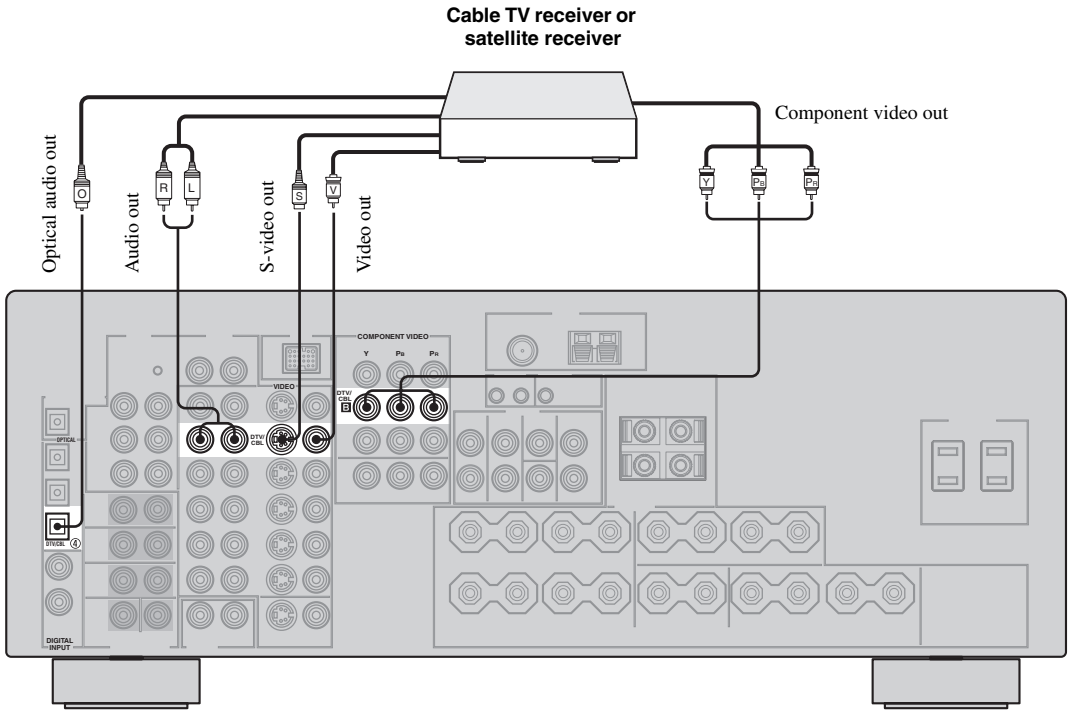

Connecting a CD player, an MD player, a tape deck or a turntable

Connect your CD player, MD player or tape deck via analog and/or digital connections.

CAUTION

Do not connect this unit or other components to the AC power supply until all connections between components are complete.

Notes

- To make a digital connection to a component other than the default component assigned to each DIGITAL INPUT or DIGITAL OUTPUT jack, select the corresponding setting for “OPTICAL OUT”, “OPTICAL IN”, or “COAXIAL IN” in “I/O ASSIGNMENT” (see page 85).
- Connect your turntable to the GND terminal of this unit to reduce noise in the signal. However, you may hear less noise without the connection to the GND terminal for some turntables.
- The PHONO jacks are only compatible with a turntable with an MM or a high-output MC cartridge. To connect a turntable with a low-output MC cartridge to the PHONO jacks, use an in-line boosting transformer or an MC-head amplifier.

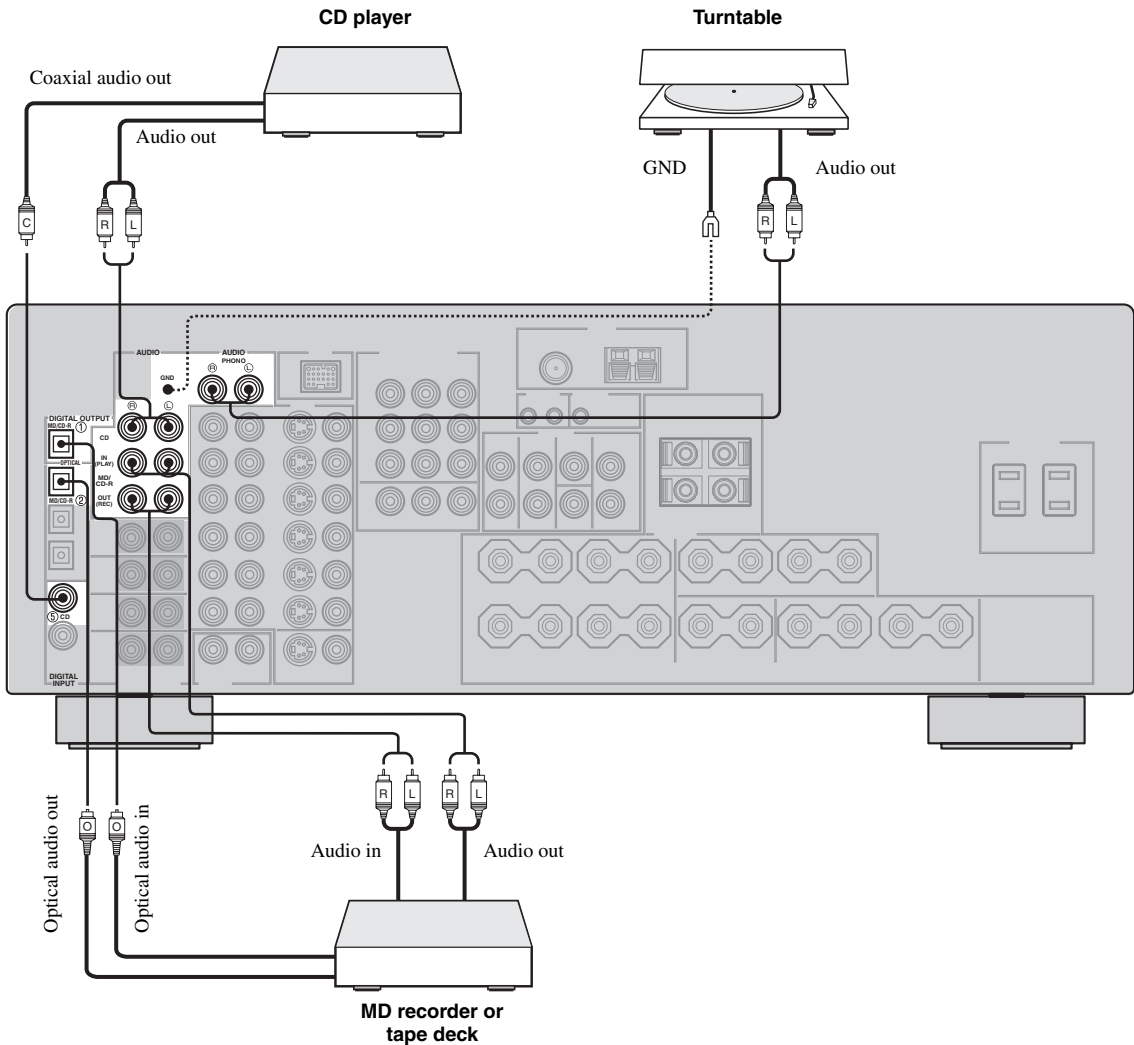

Connecting a YAMAHA iPod universal dock

This unit is equipped with the DOCK terminal on the rear panel that allows you to connect a YAMAHA iPod universal dock (such as YDS-10 sold separately) where you can station your iPod and control playback of your iPod using the supplied remote control. Connect a YAMAHA iPod universal dock (such as YDS-10 sold separately) to the DOCK terminal on the rear panel of this unit using its dedicated cable. Once the connection is complete, station your iPod in the YAMAHA iPod universal dock.

CAUTION

Do not connect this unit or other components to the AC power supply until all connections between components are complete.

Notes

- Only iPod (Click and Wheel), iPod nano, and iPod mini are supported.
- You need a YAMAHA iPod universal dock (such as YDS-10 sold separately) and its dedicated cable compatible with the DOCK terminal of this unit.
- Once your iPod is stationed in a YAMAHA iPod universal dock (such as YDS-10 sold separately) connected to the DOCK terminal of this unit, this unit begins the signal transmission with your iPod.
- Once the connection between your iPod and this unit is complete, “iPod connected” appears in the front panel display and the DOCK indicator lights up in the front panel display. If the connection between your iPod and this unit fails, a status message appears in the front panel display. For a complete list of connection status messages, see the iPod section in “TROUBLESHOOTING” on page 108.
- Only analog audio and video signals of your iPod are input at the DOCK terminal, and the analog audio signals can be output at the analog AUDIO OUT (REC) jacks for recording.
- Your iPod battery is automatically charged when your iPod is stationed in a YAMAHA iPod universal dock (such as YDS-10 sold separately) connected to the DOCK terminal of this unit as long as this unit is turned on.
- Depending on the type of iPod, you may need to insert one of the iPod adapters supplied with a YAMAHA iPod universal dock (such as YDS-10 sold separately) into the dock slot before you station your iPod.

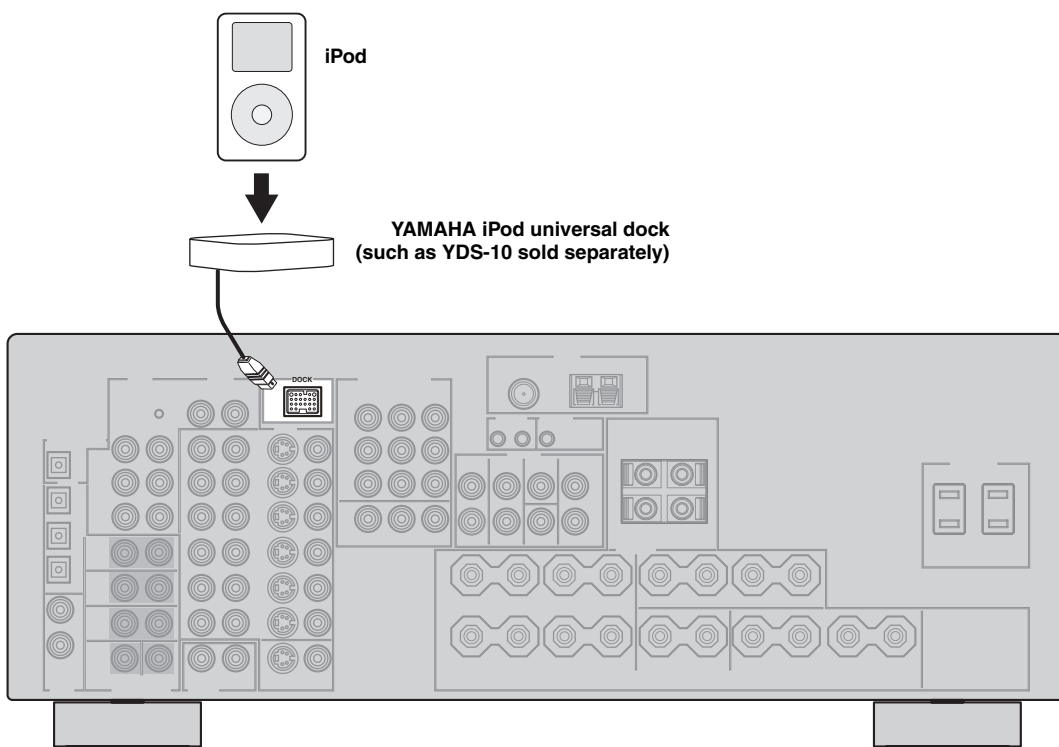

Connecting an external amplifier

This unit has more than enough power for any home use. However, if you want to add more power to the speaker output or if you want to use another amplifier, connect an external amplifier to the PRE OUT jacks.

CAUTION

Do not connect this unit or other components to the AC power supply until all connections between components are complete.

Notes

- When you make connections to the PRE OUT jacks, do not make connections to the SPEAKERS terminals.
- Set the volume level of the external amplifiers connected to the PRE OUT jacks to the maximum.
- The signals output at the FRONT PRE OUT and CENTER PRE OUT jacks are affected by the TONE CONTROL settings (see page 39).
- If SPEAKERS A is turned off (see page 38) and “SP B” is set to “ZONE B” (see page 89), signals are output only at the FRONT PRE OUT jacks.
- Each PRE OUT jack outputs the same channel signals as the corresponding SPEAKERS terminals.
- Adjust the volume level of the subwoofer with the control on the subwoofer. It is also possible to adjust the volume level with the supplied remote control (see page 42).
- Some signals may not be output at the SUBWOOFER PRE OUT jack depending on the settings for “SPEAKER SET” (see page 79) and “LFE/BASS OUT” (see page 81).
- To use the external amplifiers in Zone 2, select “EXT” in “ZONE2 AMP” (see page 89). For details, see “Using the external amplifier” on page 98.

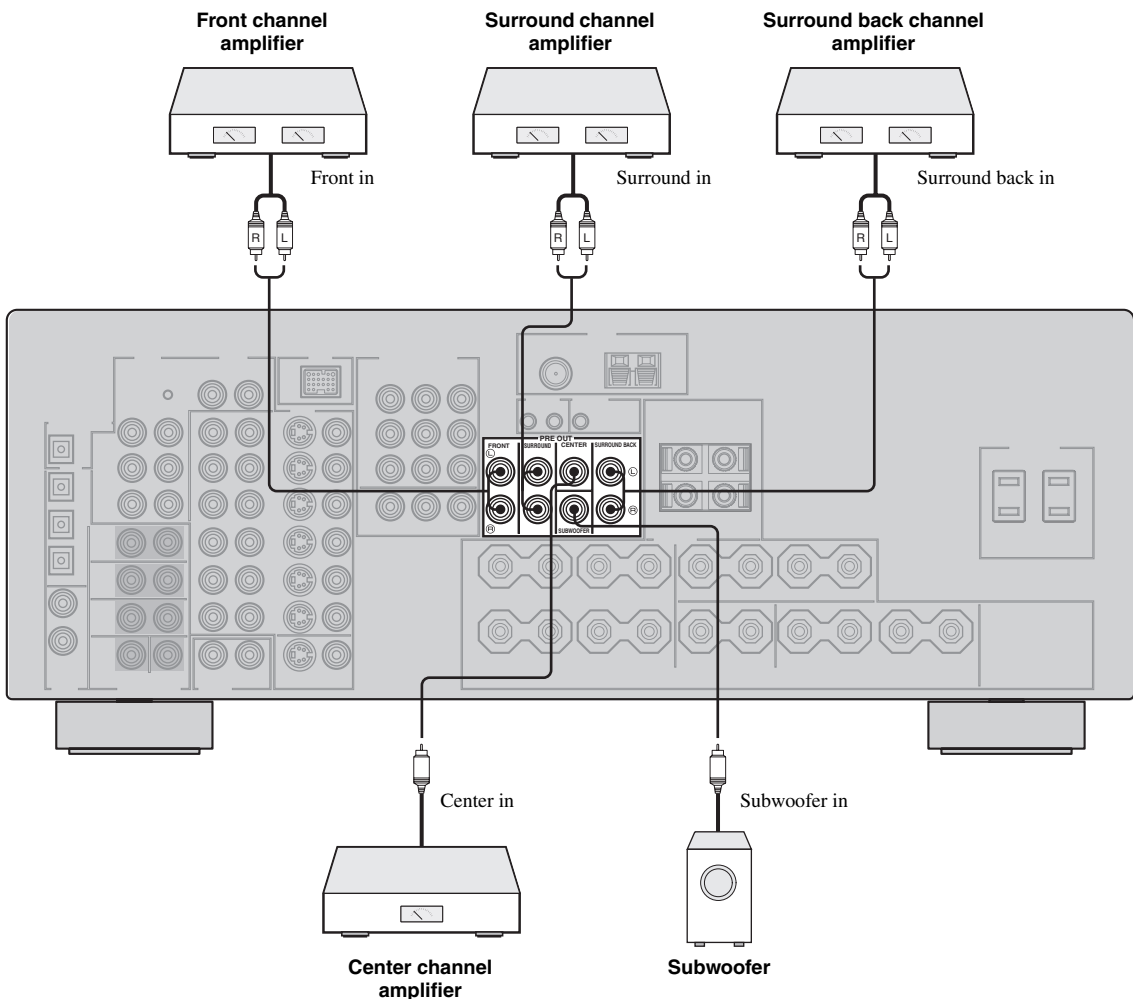

Connecting a multi-format player or an external decoder

This unit is equipped with 8 additional input jacks (FRONT L/R, CENTER, SURROUND L/R, SURROUND BACK L/R and SUBWOOFER) for discrete multi-channel input from a multi-format player, external decoder or sound processor. Connect the output jacks on your multi-format player or external decoder to the MULTI CH INPUT jacks. Be sure to match the left and right output jacks to the left and right input jacks for the front and surround channels.

CAUTION

Do not connect this unit or other components to the AC power supply until all connections between components are complete.

Notes

- When you select the component connected to the MULTI CH INPUT jacks as the input source (see page 44), this unit automatically turns off the digital sound field processor, and you cannot select sound field programs.
- This unit does not redirect signals input at the MULTI CH INPUT jacks to accommodate for missing speakers. We recommend that you connect at least a 5.1-channel speaker system before using this feature.
- When headphones are used, signals are output only from the front left and right channels.

For 6-channel input

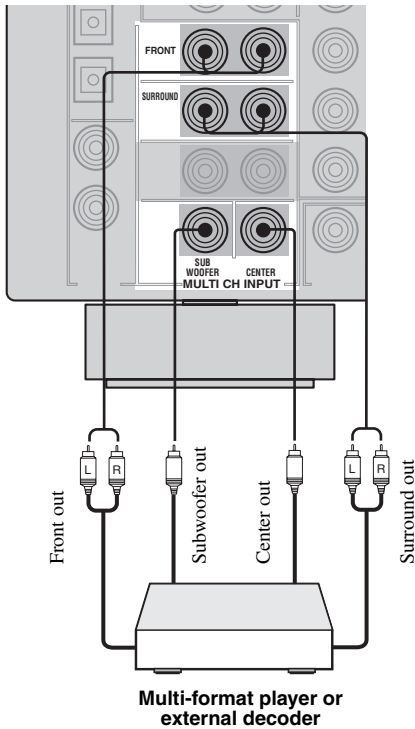

For 8-channel input

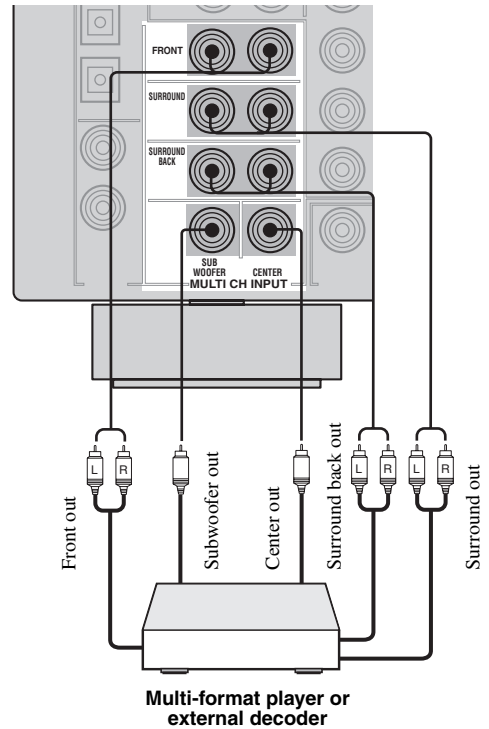

Connecting a game console, a video camera or a portable audio player

Use the VIDEO AUX jacks on the front panel to connect a game console or a video camera to this unit.

CAUTION

Be sure to turn off the volume of this unit and other components before making connections.

Note

The audio signals input at the DOCK terminal on the rear panel take priority over the ones input at the VIDEO AUX jacks.

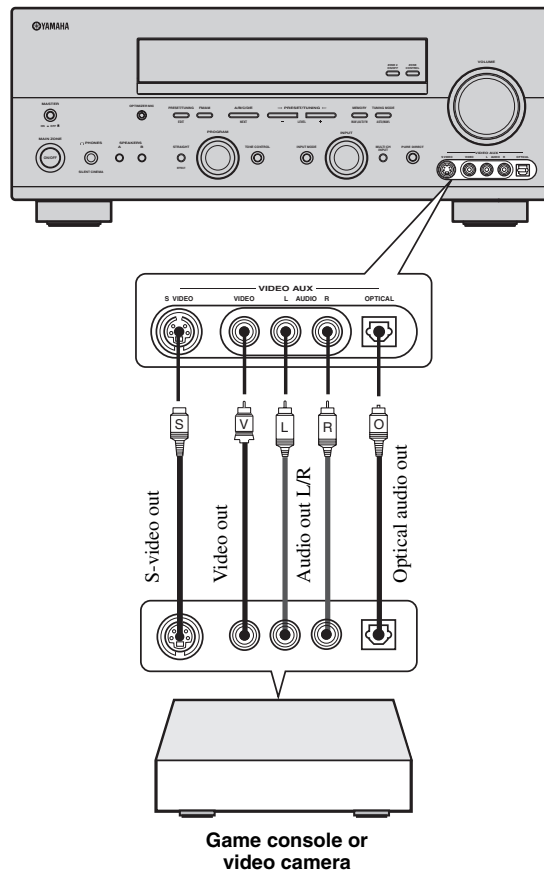

Connecting the FM and AM antennas

Both FM and AM indoor antennas are supplied with this unit. In general, these antennas should provide sufficient signal strength. Connect each antenna correctly to the designated terminals.

Notes

- Be sure to set the tuner frequency step (Asia and General models only) according to the frequency spacing in your area (see page 91).
- The AM loop antenna should be placed away from this unit.
- The AM loop antenna should always be connected, even if an outdoor AM antenna is connected to this unit.
- A properly installed outdoor antenna provides clearer reception than an indoor one. If you experience poor reception quality, install an outdoor antenna. Consult the nearest authorized YAMAHA dealer or service center about outdoor antennas.

Indoor FM antenna (supplied except for U.K. model)

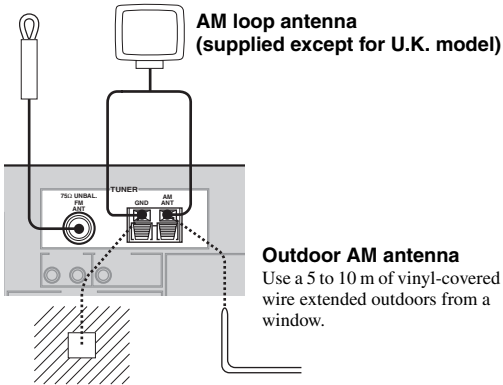

Ground (GND terminal)

For maximum safety and minimum interference, connect the antenna GND terminal to a good earth ground. A good earth ground is a metal stake driven into moist earth.

■ Connecting the AM loop antenna

1 Set up the AM loop antenna.

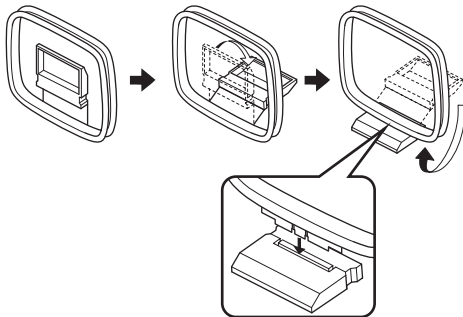

2 Press and hold the tab of the AM ANT terminal.



3 Insert one of the AM loop antenna lead wires into the AM ANT terminal.

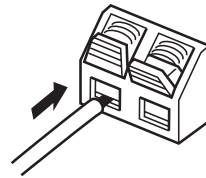

4 Release the tab of the AM ANT terminal back into place.



5 Repeat steps 2 through 4 to connect the other lead wire to the GND terminal.



Once you have properly connected the AM loop antenna to this unit, orient the AM loop antenna for the best reception when you tune into AM stations (see page 52).

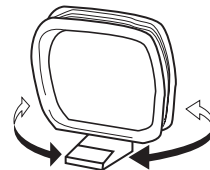

Connecting the power cable

Once all connections are complete, plug the power cable into the AC wall outlet.

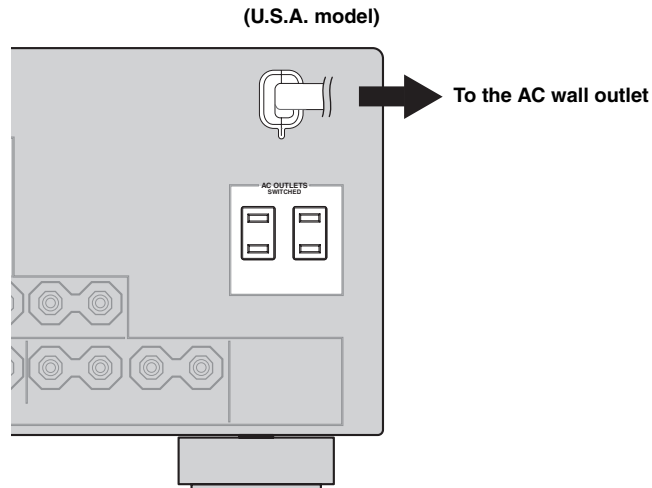

■ VOLTAGE SELECTOR (Asia and General models only)

CAUTION

The **VOLTAGE SELECTOR** on the rear panel of this unit must be set for your local voltage **BEFORE** plugging the power cable into the AC wall outlet. Improper setting of the **VOLTAGE SELECTOR** may cause damage to this unit and create a potential fire hazard.

Rotate the **VOLTAGE SELECTOR** clockwise or counterclockwise to the correct position using a straight slot screwdriver.

Voltages are as follows:

- Asia model 220/230–240 V AC, 50/60 Hz
- General model 110/120/220/230–240 V AC, 50/60 Hz

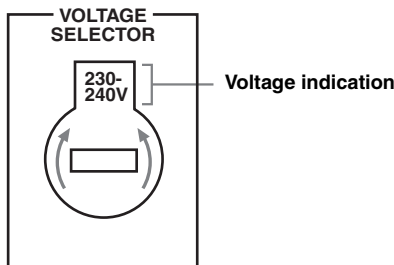

■ AC OUTLET(S) (SWITCHED)

- U.K. and Australia models 1 outlet
- Korea model None
- Other models 2 outlets

Use these outlet(s) to supply power to any connected components. Connect the power cable of your other components to these outlet(s). Power to these outlet(s) is supplied when the main zone or Zone 2 is turned on. However, power to these outlet(s) is cut off when the main zone and Zone 2 are turned off or when MASTER ON/OFF on the front panel is pressed and released outward to the OFF position. For information on the maximum power or the total power consumption of the components that can be connected to these outlet(s), see “SPECIFICATIONS” on page 114.

Memory back-up

The memory back-up circuit prevents the stored data from being lost even if this unit is in the standby mode. However, the stored data will be lost in case the power cable is disconnected from the AC wall outlet or if the power supply is cut off for more than one week.

Setting the speaker impedance

CAUTION

If you are to use 4 or 6 ohm speakers, set “SP IMP.” to “6ΩMIN” as follows BEFORE using this unit.

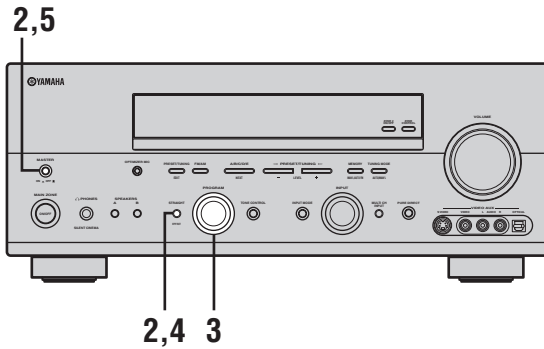

1 Make sure this unit is turned off.
See page 31 for details about turning on or off this unit.

2 Press and hold STRAIGHT (EFFECT) on the front panel and then press MASTER ON/OFF inward to the ON position to turn on this unit.
This unit turns on, and the advanced setup menu appears in the front panel display.



3 Rotate the PROGRAM selector on the front panel to select “SP IMP.”.
The following display appears in the front panel display.

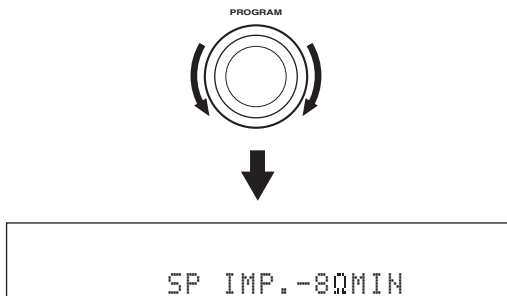

4 Press STRAIGHT (EFFECT) on the front panel repeatedly to select “6ΩMIN”.
The following display appears in the front panel display.

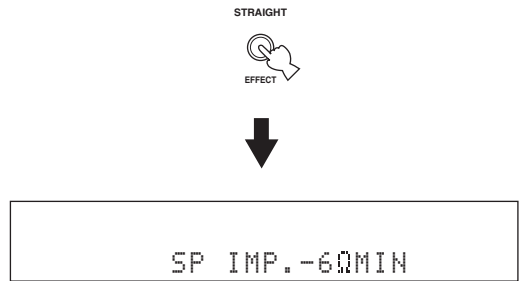

5 Press MASTER ON/OFF on the front panel to release it outward to the OFF position to save the new setting and turn off this unit.



Note

The setting you made is reflected next time you turn on this unit.

Turning on and off the power

When all connections are complete, turn on this unit.

MASTER ON/OFF

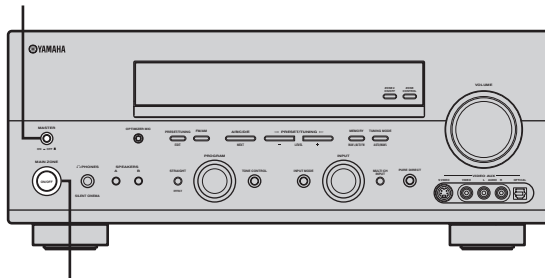

MAIN ZONE ON/OFF

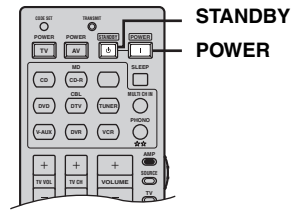

■ Turning on this unit

Press **MASTER ON/OFF** on the front panel inward to the **ON** position to turn on this unit.



Front panel

- Press **MAIN ZONE ON/OFF** on the front panel (or **STANDBY** on the remote control) to set the main zone to the standby mode.



Front panel

or



Remote control

- Press **MAIN ZONE ON/OFF** on the front panel (or **POWER** on the remote control) to turn on the main zone.



Front panel

or



Remote control

Note

MAIN ZONE ON/OFF on the front panel as well as **POWER** and **STANDBY** on the remote control are operational only when **MASTER ON/OFF** is pressed inward to the **ON** position.

■ Turning off this unit

Press **MASTER ON/OFF** on the front panel again to release it outward to the **OFF** position to turn off this unit.



Front panel

AUTO SETUP

This unit employs the YPAO (YAMAHA Parametric Room Acoustic Optimizer) technology which lets you avoid troublesome listening-based speaker setup and achieves highly accurate sound adjustments. The supplied optimizer microphone collects and analyzes the sound your speakers produce in your actual listening environment.

YPAO performs the following checks and makes appropriate adjustments to give you the best possible sound from your system.

Speaker wiring WIRING

Checks which speakers are connected and the polarity of each speaker.

Speaker distance DISTANCE

Checks the distance of each speaker from the listening position and adjusts the timing of each channel.

Speaker size SIZE

Checks the frequency response of each speaker and sets the appropriate low-frequency crossover for each channel.

Parametric equalizer EQ

Adjusts the frequency and the parametric equalizer level of each channel to reduce coloration across the channels and create a cohesive sound field. This is particularly important if you use different brands or sizes of speakers for some channels or have a room with unique sonic characteristics. In addition, the frequency response of each channel is adjusted in accordance with the sound output from your front speakers.

Volume level LEVEL

Checks and adjusts the volume level of each speaker.

Notes

- Be advised that it is normal for loud test tones to be output during the “AUTO SETUP” procedure.
- If the “AUTO SETUP” procedure stops and an error or warning message appears on your video monitor, see the “AUTO SETUP” section in “TROUBLESHOOTING” on page 109 for appropriate remedies.
- After you have completed the “AUTO SETUP” procedure, be sure to disconnect the optimizer microphone.
- The optimizer microphone is sensitive to heat. Keep it away from direct sunlight and do not place it on top of this unit.

Connecting the optimizer microphone

Connect the supplied optimizer microphone to the OPTIMIZER MIC jack on the front panel and place it in a suitable location in your listening room.



It is recommended that you use a tripod (etc.) to affix the optimizer microphone at the same height as your ears would be when you are seated in your listening position.

- 1 Connect the supplied optimizer microphone to the OPTIMIZER MIC jack on the front panel.**

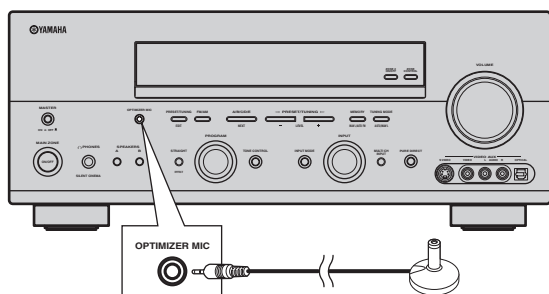

- 2 Place the optimizer microphone at your normal listening position on a flat level surface with the omni-directional microphone heading upward.**

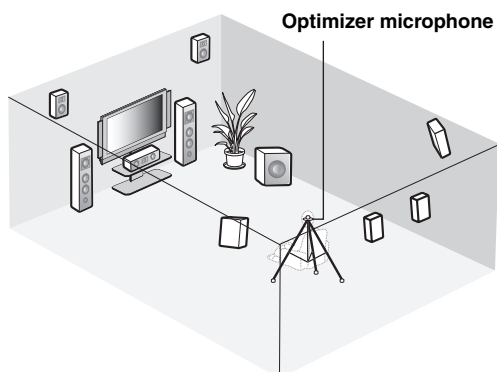

Using AUTO SETUP

Once you have connected the supplied optimizer microphone to the OPTIMIZER MIC jack on the front panel and have placed it in a suitable location in your listening room, run "AUTO SETUP" in the OSD or in the front panel display.

Note

To achieve the best results, make sure the room is as quiet as possible while the "AUTO SETUP" procedure is in progress. If there is too much ambient noise, the results may not be satisfactory.



- You can run "AUTO SETUP" using the system menu that appears in the OSD or in the front panel display. This manual uses the OSD illustrations to explain the "AUTO SETUP" procedure.
- If an error occurs during the "AUTO SETUP" procedure and an error or warning message appears in the OSD or in the front panel display, see the "AUTO SETUP" section in "TROUBLESHOOTING" on pages 109 and 110 for a complete list of error and warning messages and proper remedies.
- The initial setting for each parameter is indicated in bold.
- If the volume level and the crossover frequency of your subwoofer can be adjusted, set the volume level to about half way (or slightly less) and set the crossover frequency to the maximum.

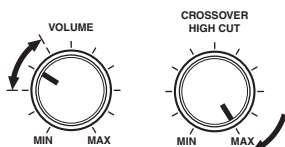

Subwoofer

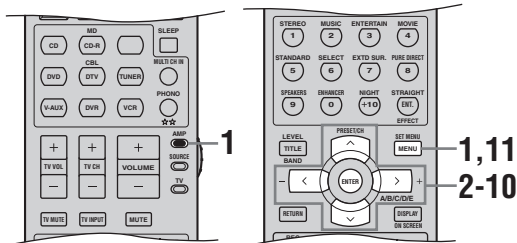

1 Set the component selector switch to AMP and then press SET MENU to enter "SET MENU".

The top "SET MENU" display appears in the OSD.

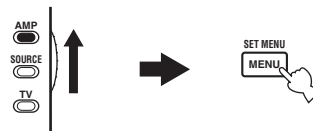

2 Press ^/∨ to select "AUTO SETUP".

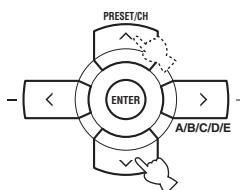

3 Press ENTER to enter "AUTO SETUP".

The "AUTO:MENU" display appears in the OSD.

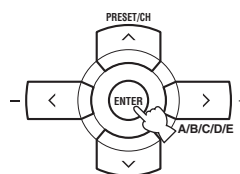

4 Press ^/∨ to select “SETUP” and then press </> to select the desired setting.

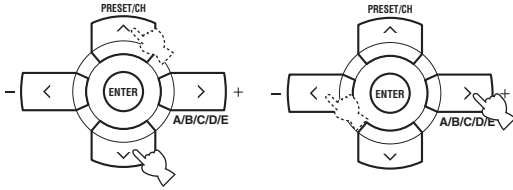

Choices: **AUTO**, RELOAD, UNDO, DEFAULT

- Select “AUTO” to automatically run the entire “AUTO SETUP” procedure.
- Select “RELOAD” to reload the last “AUTO SETUP” settings and override the previous settings.
- Select “UNDO” to undo the last “AUTO SETUP” settings and restore the previous settings.
- Select “DEFAULT” to reset the “AUTO SETUP” parameters to the initial factory settings.

Note

“RELOAD” or “UNDO” is available only when you have previously run “AUTO SETUP” and confirmed the results.

5 Press ∨ to select “START” and then press ENTER to start the setup procedure.

Loud test tones are output from each speaker and “WAITING” appears in the OSD during the “AUTO:CHECK” procedure. Once all items are set, the “RESULT:EXIT” display appears in the OSD.

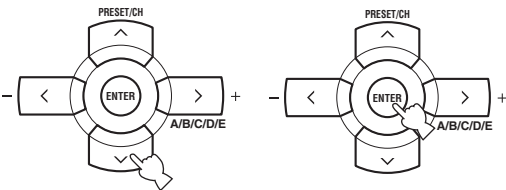

The display changes as follows.

```

1 AUTO:MENU
  SETUP.....AUTO
  → START
  Automatic
  Processing
  of all items
  [▲]/[▼]:Up/Down
  [↵]/[↵]:Select
    
```



```

1 AUTO:CHECK
  → INITIALIZING
  WIRING
  SIZE/DISTANCE
  EQUALIZING
  LEVEL
  CHECK CH=CENTER
  !!!!!.....
  [▲]: Exit
    
```



```

RESULT:EXIT
  → WARNING (3)
  RESULT
  SP : 5/4/0.1
  DIST: 4.50/ 5.30m
  LUL : -9.0/ +6.5dB
  >SET CANCEL
  [▲]/[▼]:Up/Down
  [ENTER]:Enter
    
```

The results displayed under “RESULT” are as follows:

Number of speakers SP

Displays the number of speakers connected to this unit in the following order:
Front/Back/Subwoofer

Speaker distance DIST

Displays the speaker distance from the listening position in the following order:
Closest speaker distance/Farthest speaker distance

Speaker level LUL

Displays the speaker output level in the following order:
Lowest speaker output level/Highest speaker output level

Notes

- If “E-10:INTERNAL ERROR” appears during the testing procedure, restart from step 4.
- If you selected “RELOAD”, “UNDO” or “DEFAULT” in step 4, no test tones are output.
- If an error occurs during the “AUTO:CHECK” procedure, the setup procedure is canceled and an error screen appears. For details, see “If an error screen appears” on page 37.
- The number on the right of “WARNING” indicates the number of warning messages. For details, see “If a warning screen appears” on page 37.
- Depending on the listening environment, “SWFR PHASE:REV” appears during the “AUTO:CHECK” procedure and “SUBWOOFER PHASE” in “SOUND MENU” (see page 81) is automatically set to “REVERSE”.

6 Press ∇ to select “RESULT” and then press ENTER to display the setup results in detail.

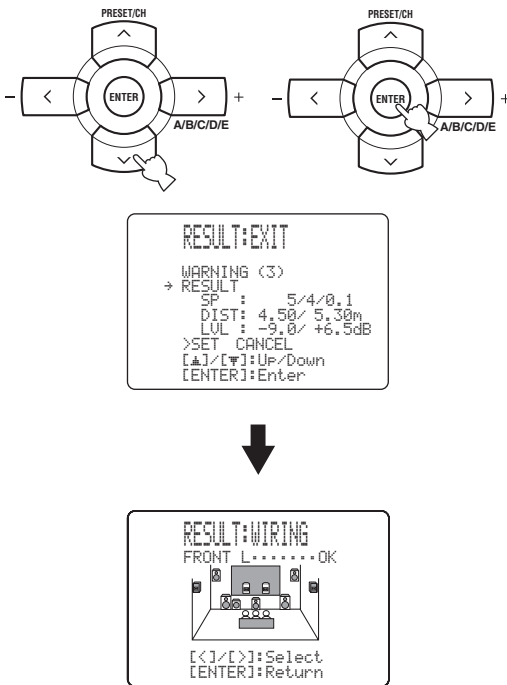

7 Press $\langle \rangle$ repeatedly to toggle between the setup result displays.

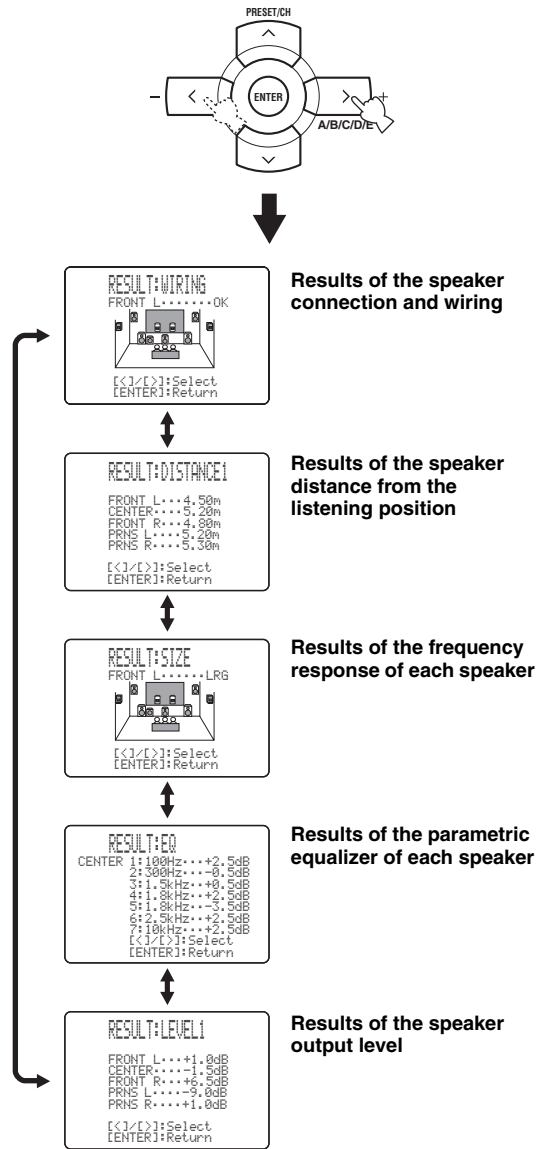

Results of the speaker connection and wiring

Results of the speaker distance from the listening position

Results of the frequency response of each speaker

Results of the parametric equalizer of each speaker

Results of the speaker output level



If you are not satisfied with the results or want to manually adjust each parameter, run “MANUAL SETUP” (see page 76).

Notes

- If you change speakers, speaker positions, or the layout of your listening environment, run “AUTO SETUP” again to recalibrate your system.
- The distances displayed in the “DISTANCE” results may be longer than the actual distance depending on the characteristics of your subwoofer.
- In the “EQ” results, different values may be set for the same band to provide finer adjustments.

8 Press ENTER to return to the top “RESULT:EXIT” display.

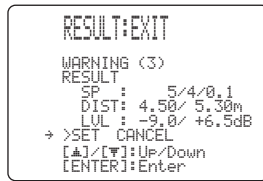
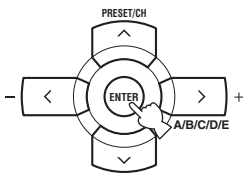

9 Make sure the pointer is pointing at “SET” and “CANCEL” and then press </> to select “SET” or “CANCEL”.

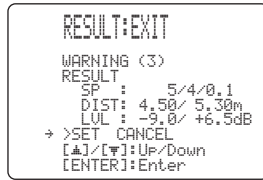
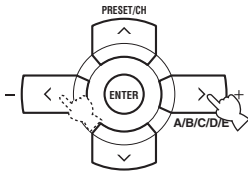

Choices: **SET**, CANCEL

- Select “SET” to confirm the “AUTO SETUP” results.
- Select “CANCEL” to cancel the “AUTO SETUP” results.

10 Press ENTER to confirm your selection.

The top “SET MENU” display appears in the OSD.

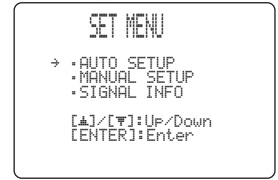
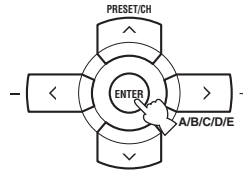

11 Press SET MENU to exit from “SET MENU”.



■ If an error screen appears

Press $\wedge/\vee/⟨/⟩$ to select “RETRY” or “EXIT” and then press ENTER.

The following display is an example where “E-9:USER CANCEL” appears in the OSD.

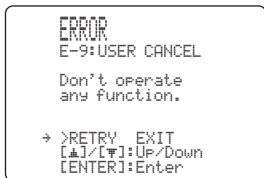

Choices: **RETRY**, EXIT

- Select “RETRY” to retry the “AUTO SETUP” procedure.
- Select “EXIT” to exit from the “AUTO SETUP” procedure.

■ If a warning screen appears

Warning messages inform you of potential problems detected during the “AUTO SETUP” procedure.

Note

Warnings differ from errors in that warnings do not cancel the “AUTO SETUP” procedure.

- 1 Make sure the pointer is pointing at “WARNING” and then press ENTER to display the detailed information about the warning.

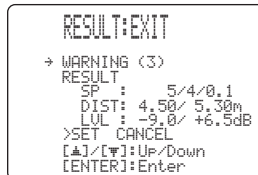

The number on the right of “WARNING” indicates the number of warning messages.

- 2 Press $⟨/⟩$ repeatedly to toggle between the warning displays.

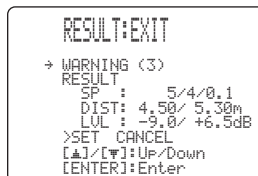

- For details about each warning message, see the “AUTO SETUP” section in “TROUBLESHOOTING” on page 109.
- When the corresponding warning message is not applicable to a speaker, “—” is displayed instead.

- 3 Press ENTER to return to the top “RESULT:EXIT” display.

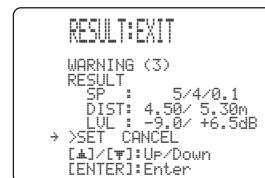
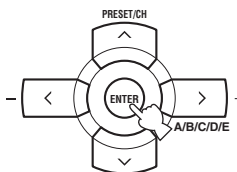

PLAYBACK

CAUTION

Extreme caution should be exercised when you play back CDs encoded in DTS. If you play back a CD encoded in DTS on a DTS-incompatible CD player, you will only hear some unwanted noise that may damage your speakers. Check whether your CD player supports CDs encoded in DTS. Also, check the sound output level of your CD player before you play back a CD encoded in DTS.

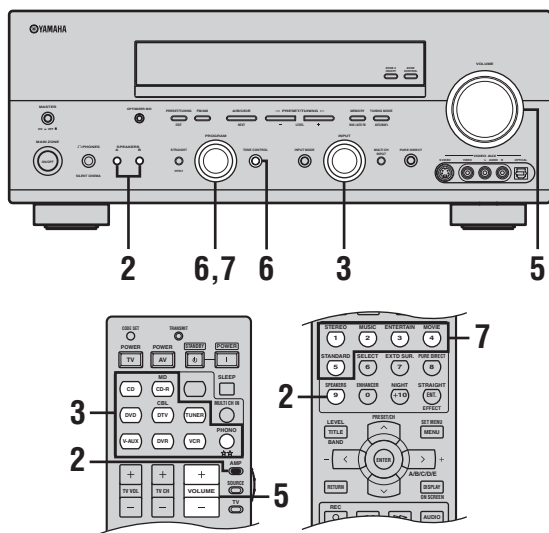

- 3 Rotate the INPUT selector on the front panel (or press one of the input selector buttons on the remote control) to select the desired input source.

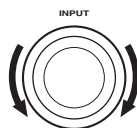

Front panel

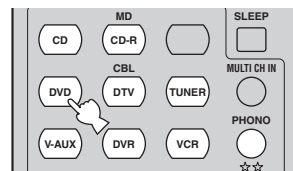

Remote control

The name of the currently selected input source appears in the front panel display and in the OSD for a few seconds.

Available input sources

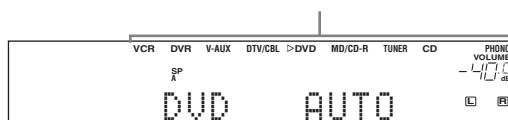

Currently selected input source

Currently selected input mode

- 1 Turn on the video monitor connected to this unit.

- 2 Press SPEAKERS A or B on the front panel (or set the component selector switch to AMP and then press SPEAKERS on the remote control repeatedly).

Each time you press SPEAKERS A or B, the respective speakers are turned on or off.

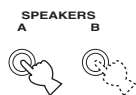

Front panel

or

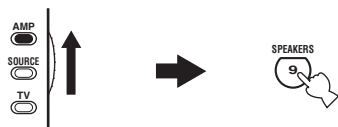

Remote control

- 4 Start playback on the selected source component or select a broadcast station.

Refer to the operating instructions for the source component.

See page 52 for details about tuning instructions.

Note

If you are to select an input source connected via digital connections, set "INPUT MODE" to "AUTO" or "DTS" (see page 41).

- 5 Rotate **VOLUME** on the front panel (or press **VOLUME +/-** on the remote control) to adjust the volume to the desired output level.

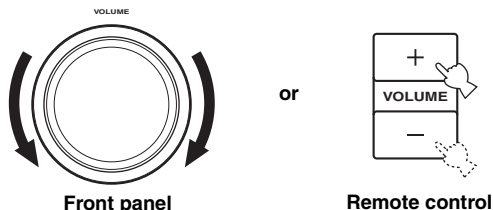

- 6 Press **TONE CONTROL** on the front panel repeatedly to select “**TREBLE**” or “**BASS**” and then rotate the **PROGRAM** selector to adjust the corresponding frequency response level.

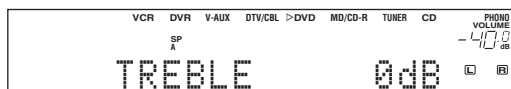
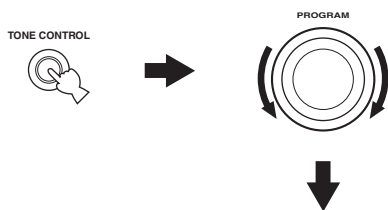

- Select “**TREBLE**” to adjust the high-frequency response.
- Select “**BASS**” to adjust the low-frequency response.

Notes

- Speaker and headphone adjustments are stored independently.
- When “**TONE BYPASS**” is set to “**AUTO**” (see page 84), and “**BASS**” and “**TREBLE**” are set to 0 dB, audio output automatically bypasses the tone control circuitry of this unit.
- If you increase or decrease the high-frequency or low-frequency sound to an extreme level, the tonal quality of the surround speakers may not match that of the front left and right speakers.
- **TONE CONTROL** is not effective when the Pure Direct mode (see page 45) is selected or when the component connected to the **MULTI CH INPUT** jacks is selected as the input source (see page 44).
- To enjoy multi-channel sources in surround, see page 48 for details.

- 7 Rotate the **PROGRAM** selector on the front panel (or press one of the sound field program selector buttons on the remote control repeatedly) to select the desired sound field program.

The name of the selected sound field program appears in the front panel display and in the OSD.

See page 64 for details about sound field programs.



or

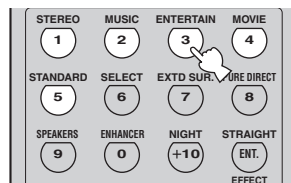

Remote control



Currently selected surround field program

Notes

- Choose a sound field program based on your listening preference, not merely on the name of the program.
- When you select an input source, this unit automatically selects the last sound field program used with the corresponding input source.
- Sound field programs cannot be selected when the component connected to the **MULTI CH INPUT** jacks is selected as the input source (see page 44).
- Sampling frequencies higher than 48 kHz (except for DTS 96/24 signals) are sampled down to 48 kHz and then sound field programs are applied.
- To display information about the currently selected input source in the OSD, see page 46 for details.

USING AUDIO FEATURES

Using SILENT CINEMA

SILENT CINEMA allows you to enjoy multi-channel music or movie sound, including Dolby Digital and DTS sources, through ordinary headphones. SILENT CINEMA activates automatically whenever you connect headphones to the PHONES jack while listening to CINEMA DSP or HiFi DSP sound field programs (see page 64). When activated, the SILENT CINEMA indicator lights up in the front panel display.

Notes

- SILENT CINEMA does not activate when the component connected to the MULTI CH INPUT jacks is selected as the input source (see page 44).
- SILENT CINEMA is not effective when the Pure Direct (see page 45) or “2ch Stereo” mode (see page 45) is selected, or when this unit is in the “STRAIGHT” mode (see page 45).

Muting the audio output

Press **MUTE** on the remote control to mute the audio output. Press **MUTE** again to resume the audio output.



- You can also rotate VOLUME on the front panel or VOLUME +/- on the remote control to resume the audio output.
- You can adjust the muting level by using the “MUTING TYPE” parameter in “SOUND MENU” (see page 84).
- The MUTE indicator flashes in the front panel display when the audio output is muted and disappears from the front panel display when the audio output is resumed.

Note

If you change the input source or the sound field program while the audio output is being muted, this unit resumes the audio output.

Selecting the night listening mode

The night listening modes are designed to improve listenability at lower volumes or at night. Choose either “NIGHT:CINEMA” or “NIGHT:MUSIC” depending on the type of material you are playing.

- 1 Set the component selector switch to **AMP** and then press **NIGHT** on the remote control repeatedly to select “NIGHT:CINEMA” or “NIGHT:MUSIC”.



Choices: NIGHT:CINEMA, NIGHT:MUSIC, OFF

- Select “NIGHT:CINEMA” when watching films to reduce the dynamic range of film soundtracks and make dialog easier to hear at lower volumes.
- Select “NIGHT:MUSIC” when listening to music sources to preserve ease-of-listening for all sounds.
- Select “OFF” if you do not want to use this feature.



When a night listening mode is selected, the NIGHT indicator lights up in the front panel display.

- 2 Press **</>** on the remote control to adjust the effect level while “NIGHT:CINEMA” or “NIGHT:MUSIC” is displayed in the front panel display.

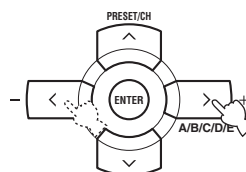

Remote control



Effect.Lvl: MID

Choices: MIN, **MID**, MAX

- Select “MIN” for minimum compression.
- Select “MID” for standard compression.
- Select “MAX” for maximum compression.



“NIGHT:CINEMA” and “NIGHT:MUSIC” adjustments are stored independently.

Notes

- You cannot use the night listening modes in the following cases:
 - when the Pure Direct mode (see page 45) is selected.
 - when the component connected to the MULTI CH INPUT jacks is selected as the input source (see page 44).
 - when headphones are connected to the PHONES jack.
- The night listening modes may vary in effectiveness depending on the input source and surround sound settings you use.

Selecting the input mode

This unit comes with a variety of input jacks. Do the following to select the type of input signals you want to use.



- We recommend setting “INPUT MODE” to “AUTO” in most cases.
- You can adjust the default input mode of this unit by using the “INPUT MODE” parameter in “INPUT MENU” (see page 86).

Notes

- To play DTS-encoded CDs when using a digital audio connection, be sure to set “INPUT MODE” to “DTS”.
- DTS decoding may not be performed correctly depending on the player even if you make a digital connection between this unit and the player.

1 Rotate the INPUT selector on the front panel to select the desired input source.

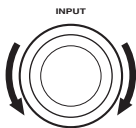

2 Press INPUT MODE on the front panel repeatedly to select the desired input mode.

INPUT MODE



Available input sources



Currently selected input source

Currently selected input mode

- AUTO** Automatically selects input signals in the following order:
 - (1) Digital signals
 - (2) Analog signals
- DTS** Selects only digital signals encoded in DTS. If no DTS signals are input, no sound is output.
- ANALOG** Selects only analog signals. If no analog signals are input, no sound is output.

Note

When “INPUT MODE” is set to “AUTO”, this unit automatically switches to the appropriate decoder if a Dolby Digital or DTS signal is detected.

Using the sleep timer

Use this feature to automatically set this unit to the standby mode after a certain amount of time. The sleep timer is useful when you are going to sleep while this unit is playing or recording a source. The sleep timer also automatically turns off any external components connected to AC OUTLET(S) (see page 29).

1 Press one of the input selector buttons on the remote control to select the desired input source.

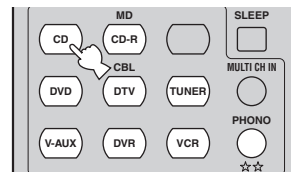

2 Start playback on the selected source component or select a broadcast station.

Refer to the operating instructions for the source component.

See page 52 for details about tuning instructions.

3 Press SLEEP on the remote control repeatedly to set the amount of time.

Each time you press SLEEP, the front panel display changes as shown below.

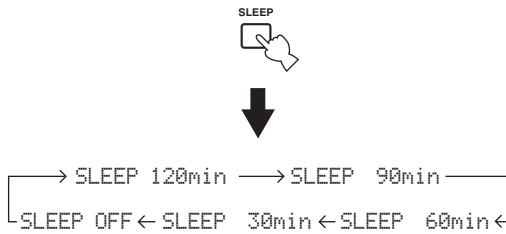

The SLEEP indicator flashes while you are switching the amount of time for the sleep timer. Once the sleep timer is set, the SLEEP indicator lights up in the front panel display, and the display returns to the selected sound field program.

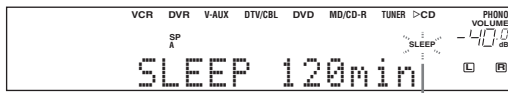

Flashes

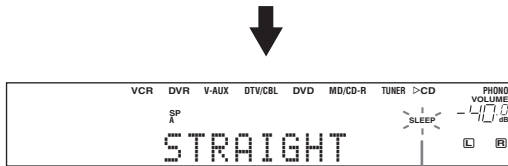

Lights up

4 To cancel the sleep timer, press SLEEP on the remote control repeatedly until "SLEEP OFF" appears in the front panel display.

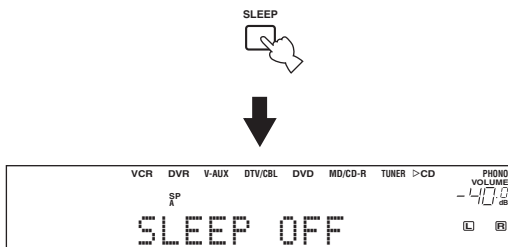

The SLEEP indicator turns off, and "SLEEP OFF" disappears from the front panel display after a few seconds.



The sleep timer setting can also be canceled by pressing STANDBY on the remote control (or MAIN ZONE ON/OFF on the front panel) to set the main zone to the standby mode.

Adjusting the speaker level

You can adjust the output level of each speaker while listening to a music source. This is also possible when playing sources input at the MULTI CH INPUT jacks.

Note

This operation will override the level adjustments made in "AUTO SETUP" (see page 32) and "SPEAKER LEVEL" (see page 82).



This operation can also be performed using the control buttons on the front panel. Press NEXT on the front panel repeatedly to select the speaker channel whose output level you want to adjust and then press LEVEL +/- on the front panel to adjust the output level.

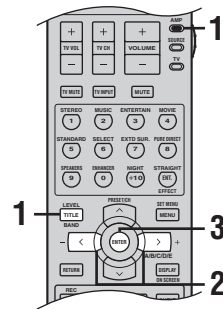

1 Set the component selector switch to AMP and then press LEVEL on the remote control repeatedly to select the speaker you want to adjust.

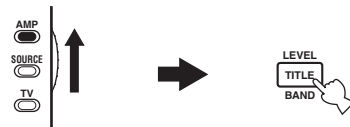

- Select “FRONT L” to adjust the front left speaker output level.
- Select “CENTER” to adjust the center speaker output level.
- Select “FRONT R” to adjust the front right speaker output level.
- Select “SUR. R” to adjust the surround right speaker output level.
- Select “SUR. B. R” to adjust the surround back right speaker output level.
- Select “SUR. B. L” to adjust the surround back left speaker output level.
- Select “SUR. L” to adjust the surround left speaker output level.
- Select “SWFR” to adjust the subwoofer output level.
- Select “PRES. R” to adjust the presence right speaker output level.
- Select “PRES. L” to adjust the presence left speaker output level.



- Once you press LEVEL on the remote control, you can also select the speaker by pressing \wedge / \vee .
- Instead of “SUR. B. R” and “SUR. B. L”, “SUR. B” is displayed if “SUR. B L/R SP” is set to either “SMLx1” or “LRGx1” (see page 80).

2 Press \langle / \rangle on the remote control to adjust the speaker output level.

- Press \rangle to increase the value.
- Press \langle to decrease the value.

Control range: -10 dB to +10 dB

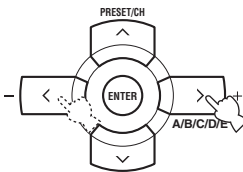

3 Press ENTER on the remote control when you have completed your adjustment.

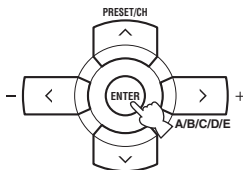

Selecting the Compressed Music Enhancer mode

Compression artifacts (such as the MP3 format) are created by a lossy compression scheme where the audio is resampled to lower the bitrate and to remove sounds that are indistinguishable to typical human hearing. The Compressed Music Enhancer feature of this unit enhances your listening experience by regenerating the missing harmonics in a compression artifact. As a result, flattened complexity due to the loss of high-frequency fidelity as well as lack of bass due to the loss of low-frequency bass is compensated, providing the improved performance of the overall sound system.

Notes

- The Compressed Music Enhancer mode is compatible with the PCM signals (32 kHz, 44.1 kHz and 48 kHz) and the analog 2-channel input sources.
- The Compressed Music Enhancer mode is not effective with any of the sound field programs.
- When the Compressed Music Enhancer mode is turned on while an incompatible input source is being played back, “Not Available” appears in the front panel display and in the OSD.
- When the input source is changed to an incompatible input source while the Compressed Music Enhancer mode is turned on, the Compressed Music Enhancer mode is automatically turned off and the incompatible input source is played back in 2-channel or 7-channel stereo.



The ENHANCER indicator lights up in the front panel display when one of the Compressed Music Enhancer modes is selected.

- 1 Set the component selector switch to AMP and then press ENHANCER on the remote control repeatedly to select the desired **Compressed Music Enhancer mode**.

The following display is shown in the OSD and the ENHANCER indicator lights up in the front panel display.

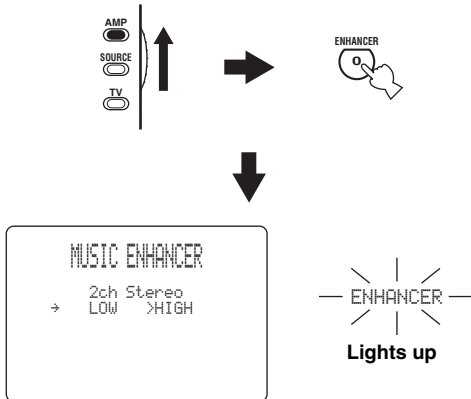

Choices: **2ch Stereo**, 7ch Stereo, Off

- Select “2ch Stereo” to play back compression artifacts in 2-channel stereo.
- Select “7ch Stereo” to play back compression artifacts in 7.1-channel stereo.
- Select “Off” to turn off the Compressed Music Enhancer mode.

Note

When you select “Off”, this unit returns to the previously selected sound field program.

- 2 Press **</>** on the remote control to select the desired effect level.

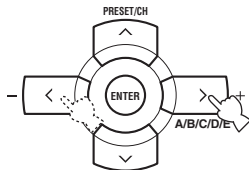

Choices: **HIGH**, LOW

- Select “HIGH” for a high effect level.
- Select “LOW” for a low effect level.

Note

Set the effect level to “HIGH” or “LOW” according to the characteristics of a source. The high-frequency signals of some sources may be emphasized too much. In this case, set the effect level to “LOW”.

Selecting the MULTI CH INPUT component

Use this feature to select the component connected to the MULTI CH INPUT jacks (see page 26) as the input source.

Press **MULTI CH INPUT** on the front panel (or **MULTI CH IN** on the remote control) so that “MULTI CH INPUT” appears in the front panel display.

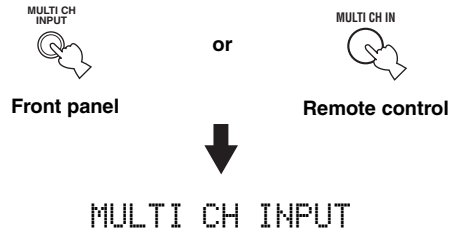

Note

When “MULTI CH INPUT” is shown in the front panel display, no other source can be played. To select another input source with the INPUT selector on the front panel (or one of the input selector buttons), press MULTI CH INPUT (or MULTI CH IN on the remote control) so that “MULTI CH INPUT” disappears from the front panel display.

Enjoying multi-channel sources in 2-channel stereo

You can mix down multi-channel sources to 2 channels and enjoy playback in 2-channel stereo.

Set the component selector switch to AMP and then press STEREO on the remote control repeatedly to select “2ch Stereo”.

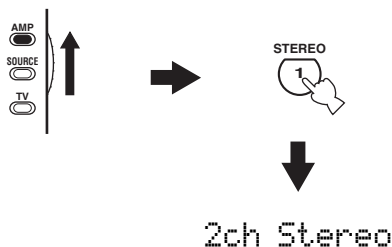

- You can use a subwoofer with this program when “LFE/BASS OUT” is set to “SWFR” or “BOTH” (see page 81).
- You can also select the “2ch Stereo” mode by rotating the PROGRAM selector on the front panel.

Enjoying unprocessed input sources

When this unit is in the “STRAIGHT” mode, 2-channel stereo sources are output from only the front left and right speakers. Multi-channel sources are decoded straight into the appropriate channels without any additional effect processing.

1 Set the component selector switch to AMP and then press STRAIGHT on the remote control to select “STRAIGHT”.

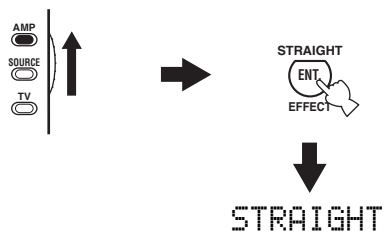

2 To deactivate the “STRAIGHT” mode, press STRAIGHT on the remote control again so that “STRAIGHT” disappears from the front panel display.

The sound effect is turned back on.



You can also select the “STRAIGHT” mode by pressing STRAIGHT (EFFECT) on the front panel.

Enjoying pure hi-fi stereo sound

The Pure Direct mode turns off the video circuitry and the front panel display, allowing sources to bypass the decoders and DSP processors of this unit so that you can enjoy pure hi-fi sound from 2-channel PCM and analog sources.

Press PURE DIRECT on the front panel (or set the component selector switch to AMP and then press PURE DIRECT on the remote control) to turn on or off the Pure Direct mode.

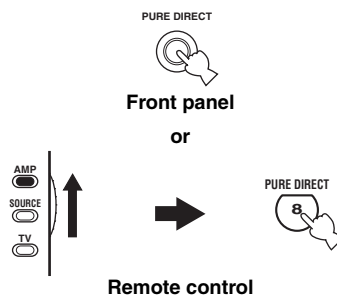

Notes

- To avoid unexpected noise, do not play CDs encoded in DTS when this unit is in the Pure Direct mode.
- When multi-channel signals (Dolby Digital and DTS) are input, this unit automatically switches to the corresponding analog input. When “DTS” is selected as the input mode (see page 41), no sound will be output.
- No sound will be output from the subwoofer.
- The front panel display automatically dims.
- The following operations are not possible when this unit is in the Pure Direct mode:
 - switching the sound field program
 - displaying the OSD
 - adjusting the “SET MENU” parameters (except for speaker level settings)
 - operating video functions (video conversion, etc.)
- The Pure Direct mode is automatically canceled whenever this unit is turned off.



- The indicator around the PURE DIRECT button on the front panel lights up while this unit is in the Pure Direct mode.
- The front panel display turns on momentarily when an operation is performed.

USING VIDEO FEATURES

Displaying the input source information

You can display the format, sampling frequency, channel, bit rate and flag data of the current input signal.

- 1 Set the component selector switch to AMP and then press SET MENU on the remote control.**

The top "SET MENU" display appears in the OSD.



- 2 Press ∇ repeatedly to select "SIGNAL INFO" and then press ENTER.**

The following information about the input source appears in the OSD.

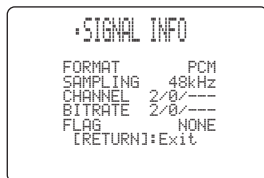
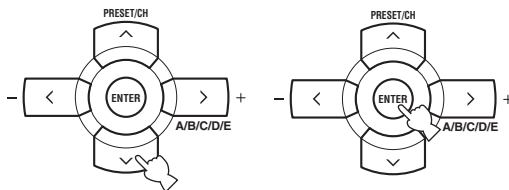

Signal format FORMAT

Signal format display. When this unit cannot detect a digital signal, it automatically switches to analog input.

Display status: Analog, Digital, DolbyD, DTS, PCM,

Note

"---" appears when this unit cannot detect any signals.

Sampling frequency SAMPLING

The number of samples per second taken from a continuous signal to make a discrete signal.

Display status: 32kHz, 44.1kHz, 48kHz, 64kHz, 88.2kHz, 96kHz, ---

Note

"---" appears when this unit cannot detect the sampling frequency.

Channel CHANNEL

The number of source channels in the input signal (front/surround/LFE). For example, a multi-channel soundtrack with 3 front channels, 2 surround channels and LFE, is displayed as "3/2/0.1".

Note

"---" appears when there is no source channel available.

Bit rate BITRATE

The number of bits passing a given point per second.

Note

"---" appears when this unit cannot detect the bit rate.

Flag FLAG

Flag data encoded in DTS, Dolby Digital, or PCM signals that cue this unit to automatically switch decoders.

- 3 Press SET MENU on the remote control again to exit from "SET MENU".**



Selecting the OSD mode

You can display the operating information of this unit on a video monitor. If you display the "SET MENU" and sound field program parameter settings on a video monitor, it is much easier to see the available options and parameters than it is to read the information in the front panel display.

- 1 Turn on the video monitor connected to this unit.
- 2 Set the component selector switch to AMP and then press DISPLAY on the remote control repeatedly to toggle between the OSD modes.

The OSD mode changes in the following order.

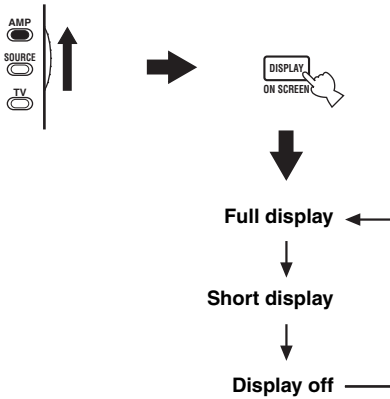

Full display

Fully shows the sound field program parameter settings as well as the contents of the front panel display.

Short display

Briefly shows the contents of the front panel display at the bottom of the screen each time you operate this unit.

Display off

No information is displayed except for the "SET MENU" screen.

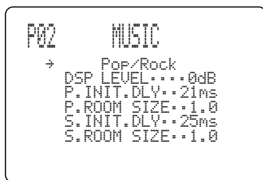

Full display

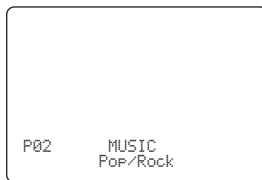

Short display



You can display a gray background in the OSD when there is not video signal being input by setting "GRAY BACK" in "OPTION MENU" to "AUTO" (see page 88).

Notes

- The OSD signal is not output at the DVR/VCR OUT jacks and will not be recorded.
- You must set "VIDEO CONV." in "OPTION MENU" to "ON" (see page 87) to display the OSD.
- To display the OSD with the component video signals output at the COMPONENT VIDEO MONITOR OUT jacks, set the OSD mode to the full display mode.
- When "GRAY BACK" in "OPTION MENU" is set to "OFF" (see page 88), the OSD may not be displayed correctly depending on the conditions of the picture.

Playing video sources in the background

You can combine a video image from a video source with sound from an audio source. For example, you can enjoy listening to classical music while viewing beautiful scenery from the video source on the video monitor.

Press the input selector buttons on the remote control to select a video source and then an audio source.

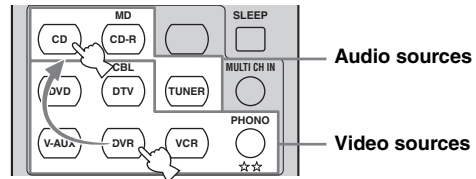

Note

If you want to enjoy an audio source input at the MULTI CH INPUT jacks together with a video source, first select the video source and then press MULTI CH INPUT on the front panel (or MULTI CH IN on the remote control) to select the component connected to the MULTI CH INPUT jacks as the input source (see page 44).

ENJOYING SURROUND SOUND

Enjoying multi-channel sources in surround

If you connected surround back speakers, use this feature to enjoy 6.1/7.1-channel playback for multi-channel sources using the Dolby Pro Logic IIX, Dolby Digital EX or DTS-ES decoders.

- 1 Set the component selector switch to AMP and then press EXT D SUR. on the remote control repeatedly to switch between 5.1 and 6.1/7.1-channel playback.

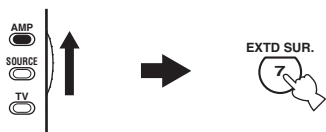

- 2 Press </> repeatedly to select a decoder while “PLIIXMusic” (etc.) is displayed.

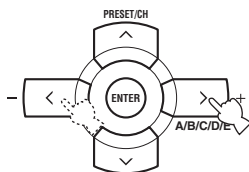

Auto AUTO

When a signal flag that can be recognized by this unit is input, this unit selects the optimum decoder to play back the signal in 6.1/7.1 channels.

If this unit cannot recognize the flag or no flag is present in the input signal, it cannot automatically be played in 6.1/7.1 channels.

Decoders

You can select from the following decoders depending on the format of the source you are playing.

Decoder	Functions
PLIIXMovie	Plays back Dolby Digital or DTS signals in 7.1 channels using the Pro Logic IIX movie decoder.
PLIIXMusic	Plays back Dolby Digital or DTS signals in 6.1/7.1 channels using the Pro Logic IIX music decoder.
EX/ES	Plays back Dolby Digital or DTS signals in 6.1/7.1 channels using the Dolby Digital EX or DTS-ES decoder.
EX	Plays back Dolby Digital or DTS signals in 6.1/7.1 channels using the Dolby Digital EX decoder.

Off OFF

Decoders are not used to create 6.1/7.1 channels.

Notes

- “PLIIXMovie” is available only when “SUR. B L/R SP” (see page 80) is set to “SMLx2” or “LRGx2”.
- Some 6.1/7.1-channel compatible discs do not have a signal flag that can be automatically detected by this unit. When playing these kinds of discs in 6.1/7.1 channels, select a decoder manually from “PLIIX Music”, “EX/ES” or “EX”.
- 6.1/7.1-channel playback is not possible even if you press EXT D SUR. in the following cases:
 - when “SUR. L/R SP” (see page 80) or “SUR. B L/R SP” (see page 80) is set to “NONE”.
 - when the component connected to the MULTI CH INPUT jacks is being played.
 - when the source being played does not contain surround left and right channel signals.
 - when a Dolby Digital KARAOKE source is being played.
 - when the “2ch Stereo” (see page 45) or Pure Direct (see page 45) mode is selected.
- When this unit is turned off, this setting will be reset to “AUTO”.
- The Pro Logic IIX decoder is not available when “SUR. B L/R SP” is set to “NONE” (see page 80).

Enjoying 2-channel sources in surround

Signals input from 2-channel sources can also be played back on multi-channels.

- 1 Set the component selector switch to **AMP** and then press **STANDARD** on the remote control repeatedly to switch between the “**SUR. STANDARD**” and “**SUR. ENHANCED**” programs or press **MOVIE** to select the “**MOVIE THEATER**” program.

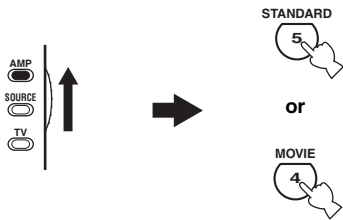

- 2 Press **SELECT** on the remote control repeatedly to select the desired decoder.



You can select from the following modes depending on the type of source you are playing and your personal preference.



You can also select a decoder by pressing </> on the remote control while the decoder type is displayed in the front panel display.

SUR. STANDARD	Functions
PRO LOGIC	Dolby Pro Logic processing for any sources
PLII Movie	Dolby Pro Logic II processing for movie sources
PLII Music	Dolby Pro Logic II processing for music sources
PLII Game	Dolby Pro Logic II processing for game sources
PLIIX Movie	Dolby Pro Logic IIX processing for movie sources
PLIIX Music	Dolby Pro Logic IIX processing for music sources
PLIIX Game	Dolby Pro Logic IIX processing for game sources
Neo:6 Cinema	DTS processing for movie sources
Neo:6 Music	DTS processing for music sources
SUR. ENHANCED or MOVIE THEATER	Functions
PRO LOGIC	Dolby Pro Logic processing for any sources
PLII Movie	Dolby Pro Logic II processing for movie sources
PLIIX Movie	Dolby Pro Logic IIX processing for movie sources
Neo:6 Cinema	DTS processing for movie sources

Note

The Pro Logic IIX decoder is not available when “SUR. B L/R SP” is set to “NONE” (see page 80).

Using Virtual CINEMA DSP

Virtual CINEMA DSP allows you to enjoy the CINEMA DSP programs without surround speakers. It creates virtual speakers to reproduce the natural sound field. If you set “SUR. L/R SP” to “NONE” (see page 80), Virtual CINEMA DSP activates automatically whenever you select a CINEMA DSP sound field program (see page 64).

Note

Virtual CINEMA DSP will not activate even when “SUR. L/R SP” is set to “NONE” (see page 80) in the following cases:

- when the component connected to the MULTI CH INPUT jacks is selected as the input source (see page 44).
- when headphones are connected to the PHONES jack.
- when the Pure Direct (see page 45) or “2ch Stereo” mode (see page 45) is selected, or when this unit is in the “STRAIGHT” mode (see page 45).

RECORDING

Recording adjustments and other operations are performed from the recording components. Refer to the operating instructions for those components.

CAUTION

The DTS signal is a digital bitstream. Attempting to digitally record the DTS bitstream will result in noise being recorded. Therefore, if you want to use this unit to record sources encoded in DTS, the following considerations and adjustments need to be made. To play DTS-encoded DVDs and CDs (when using a digital audio connection) on your DTS-compatible player, follow its operating instructions to make a setting so that the analog signal will be output from the player.

Notes

- When this unit is set to the standby mode, you cannot record between other components connected to this unit.
- The settings of TONE CONTROL (see page 39), VOLUME, the speaker level (see page 82) and the sound field programs (see page 64) do not affect recorded material.
- The source connected to the MULTI CH INPUT jacks of this unit cannot be recorded.
- S-video and composite video signals pass independently through the video circuits of this unit. Therefore, when recording or dubbing video signals input from a video source component that provides only an S-video or a composite video signal, you can record only an S-video or a composite video signal on your VCR.
- Digital signals input at the DIGITAL INPUT jacks are not output at the analog AUDIO OUT (REC) jacks for recording. Likewise, analog signals input at the AUDIO IN jacks are not output at the DIGITAL OUTPUT jack. Therefore, if your source component is connected to provide only digital or analog signals, you can only record digital or analog signals.
- A given input source is not output on the same OUT (REC) channel.
- Check the copyright laws in your country to record from CDs, radio, etc. Recording of copyrighted material may infringe copyright laws.
- The analog audio signals input at the DOCK terminal can be output at the analog AUDIO OUT (REC) jacks for recording.



Do a test recording before you start an actual recording.

If you play back a video source that uses scrambled or encoded signals to prevent it from being dubbed, the picture itself may be disturbed due to those signals.

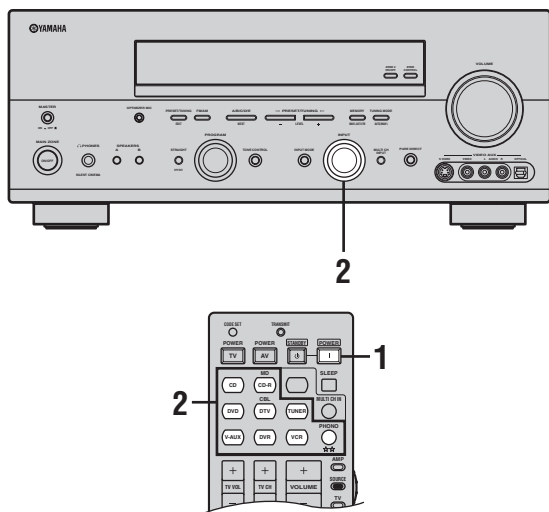

1 Turn on all the connected components.

2 Rotate the INPUT selector on the front panel (or press one of the input selector buttons on the remote control) to select the source component you want to record from.

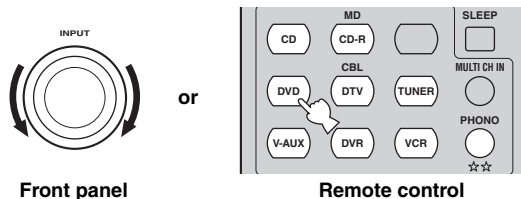

3 Start playback on the selected source component or select a broadcast station.

4 Start recording on the recording component.

FM/AM TUNING

There are 2 tuning methods: automatic and manual. Automatic tuning is effective when station signals are strong and there is no interference. If the signal from the station you want to select is weak, tune into it manually. You can also use the automatic and manual preset tuning features to store up to 40 stations (A1 to E8: 8 preset station numbers in each of the 5 preset station groups). Furthermore, you can recall any preset stations and exchange the assignment of two preset stations with each other.

Note

Orient the connected FM and AM antennas for the best reception.

Automatic tuning

Automatic tuning is effective when station signals are strong and there is no interference.

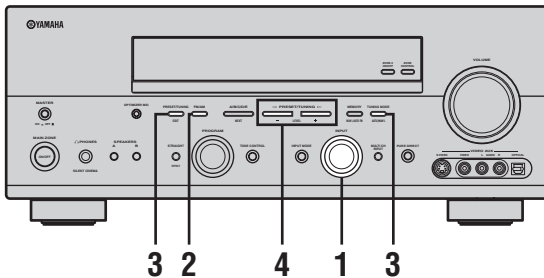

- 1 Rotate the INPUT selector to select "TUNER" as the input source.



- 2 Press FM/AM to select the reception band. "FM" or "AM" appears in the front panel display.



- 3 Press TUNING MODE (AUTO/MAN'L) so that the AUTO indicator lights up in the front panel display.

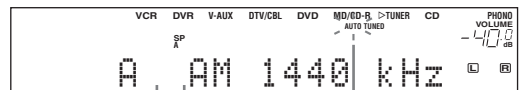
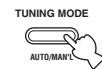

No colon (:) Lights up

If a colon (:) appears in the front panel display, tuning is not possible. Press PRESET/TUNING (EDIT) to turn the colon (:) off.

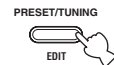

- 4 Press PRESET/TUNING </> once to begin automatic tuning.

When this unit is tuned into a station, the TUNED indicator lights up and the frequency of the received station is shown in the front panel display.

- Press > to tune into a higher frequency.
- Press < to tune into a lower frequency.

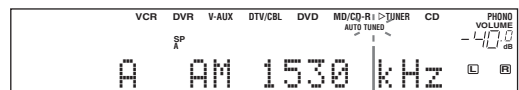

Lights up

Manual tuning

If the signal received from the station you want to select is weak, tune into it manually.

Note

Manually tuning into an FM station automatically switches the tuner to monaural reception to increase the signal quality.

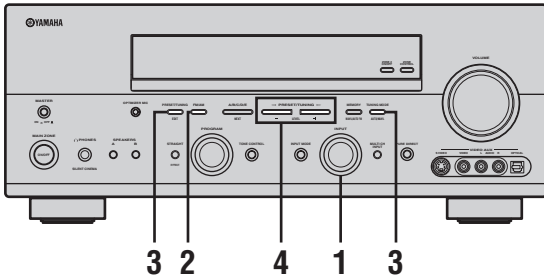

- 1 Rotate the INPUT selector to select "TUNER" as the input source.



- 2 Press FM/AM to select the reception band. "FM" or "AM" appears in the front panel display.



- 3 Press TUNING MODE (AUTO/MAN'L) so that the AUTO indicator disappears from the front panel display.

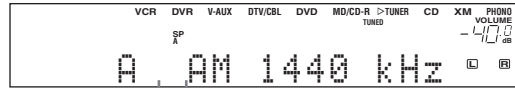

No colon (:)

If a colon (:) appears in the front panel display, tuning is not possible. Press PRESET/TUNING (EDIT) to turn the colon (:) off.

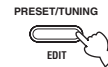

- 4 Press PRESET/TUNING </> to tune into the desired station manually.

Hold down the button to continue searching.



Automatic preset tuning

You can use the automatic preset tuning feature to store FM stations with strong signals up to 40 (A1 to E8: 8 preset station numbers in each of the 5 preset station groups) of those stations in order. You can then recall any preset station easily by selecting the preset station number.

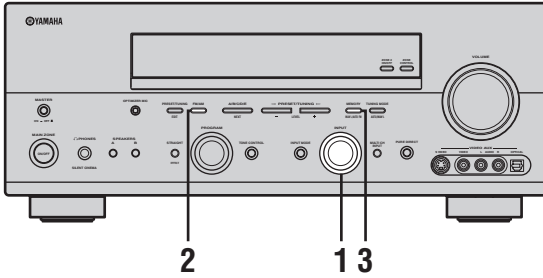

- 1 Rotate the INPUT selector to select “TUNER” as the input source.

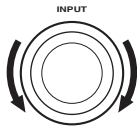

Front panel

- 2 Press FM/AM to select “FM” as the reception band.

“FM” appears in the front panel display.



- 3 Press and hold MEMORY (MAN'L/AUTO FM) for more than 3 seconds.

The preset station number as well as the MEMORY and AUTO indicators flashes. After approximately 5 seconds, automatic presetting starts from the current frequency and proceeds toward the higher frequencies.

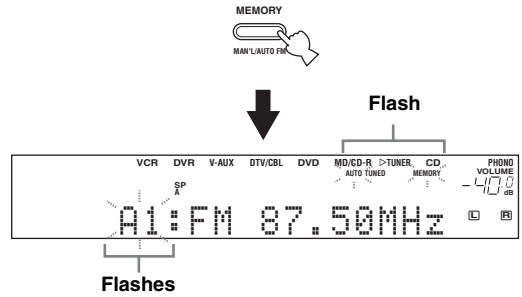

When automatic preset tuning is completed, the front panel display shows the frequency of the last preset station.



You can specify the preset number from which this unit stores FM stations and/or begins tuning toward lower frequencies. For details, see “Automatic preset tuning options” on page 55.

Notes

- Any stored station data existing under a preset station number is cleared when you store a new station under the same preset station number.
- If the number of received stations does not reach 40 (E8), automatic preset tuning automatically stops after searching for all the available stations.
- Only FM stations with sufficient signal strength are stored automatically by automatic preset tuning. If the station you want to store is weak in signal strength, tune into it manually and store it as described in “Manual preset tuning” on page 55.

Automatic preset tuning options

You can specify the preset number from which this unit stores FM stations and/or begins tuning toward lower frequencies.

Note

First carry out steps 1 through 3 in “Automatic preset tuning” on page 54.

- Press **A/B/C/D/E** and then **PRESET/TUNING** \triangleleft / \triangleright to select the preset station number under which the first station will be stored. Automatic preset tuning stops when stations have all been stored up to E8.



- Press **PRESET/TUNING** so that the colon (:) disappears from the front panel display and then press **PRESET/TUNING** \triangleleft to begin tuning toward lower frequencies.



Manual preset tuning

You can also store up to 40 stations (A1 to E8: 8 preset station numbers in each of the 5 preset station groups) manually.

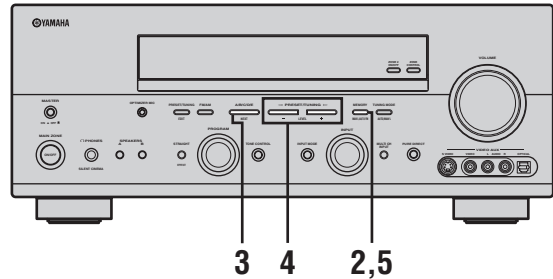

- Tune into a station automatically or manually.**
See pages 52 and 53 for tuning instructions.

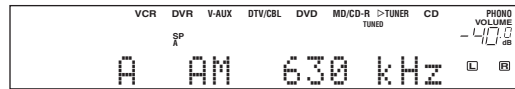

When this unit is tuned into a station, the front panel display shows the frequency of the station received.

- Press MEMORY (MAN'L/AUTO FM).**

The MEMORY indicator flashes in the front panel display for approximately 5 seconds.



- Press A/B/C/D/E repeatedly to select a preset station group (A to E) while the MEMORY indicator is flashing.**

The selected preset station group letter appears. Check that the colon (:) appears in the front panel display.

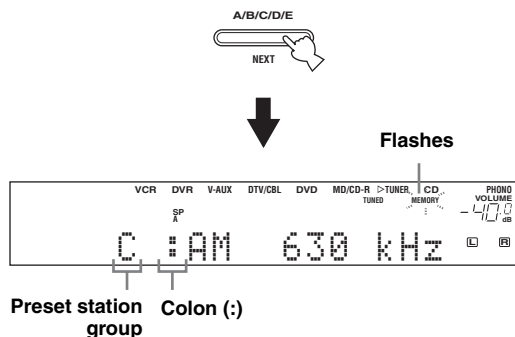

4 Press PRESET/TUNING </> to select a preset station number (1 to 8) while the MEMORY indicator is flashing.

- Press > to select a higher preset station number.
- Press < to select a lower preset station number.

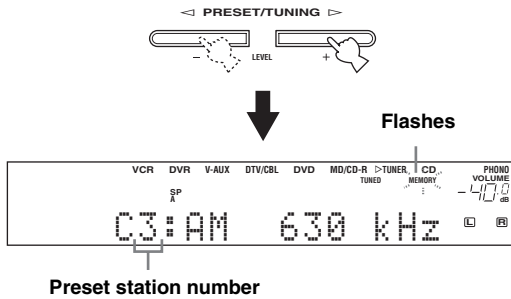

Preset station number

5 Press MEMORY (MAN'L/AUTO FM) while the MEMORY indicator is flashing.

The station band and frequency appear in the front panel display with the preset station group and number you have selected. The MEMORY indicator disappears from the front panel display.

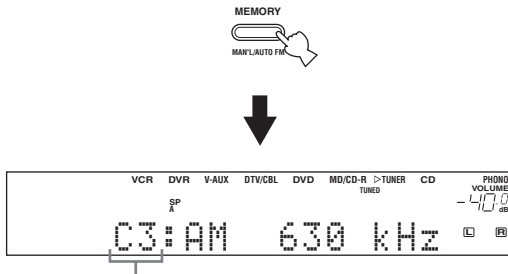

The displayed station has been stored as C3.

6 Repeat steps 1 through 5 to store other stations.

Notes

- Any stored station data existing under a preset station number is cleared when you store a new station under the same preset station number.
- The reception mode (stereo or monaural) is stored along with the station frequency.

Selecting preset stations

You can tune into any desired station simply by selecting the preset station group and number under which it was stored.

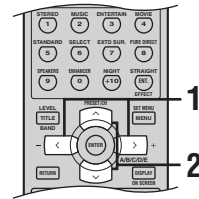
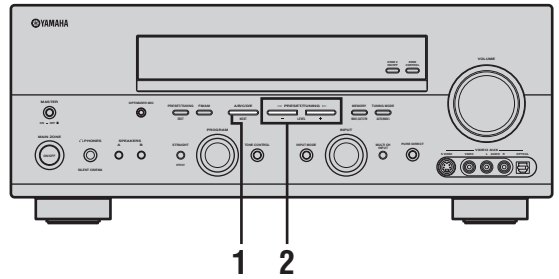

When performing this operation with the remote control, set the component selector switch to SOURCE and then press TUNER to select "TUNER" as the input source.

1 Press A/B/C/D/E on the front panel (or A/B/C/D/E </> on the remote control) to select the desired preset station group (A to E).

The preset station group letter appears in the front panel display and changes each time you press the button.

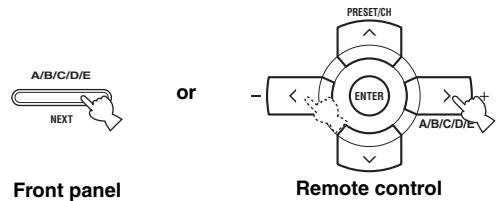

- 2** Press PRESET/TUNING $\triangleleft/\triangleright$ on the front panel (or PRESET/CH \wedge/\vee on the remote control) to select the desired preset station number (1 to 8).

The preset station group and number appear in the front panel display along with the station band and frequency.

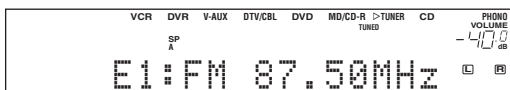
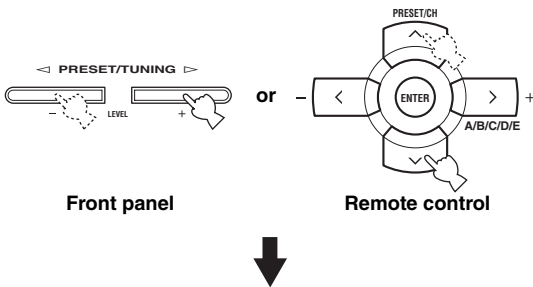

Exchanging preset stations

You can exchange the assignments of two preset stations with each other. The example below describes the procedure to exchange preset station “E1” with “A5”.

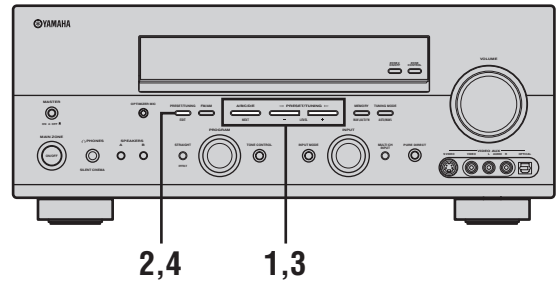

- 1** Select preset station “E1” using A/B/C/D/E and PRESET/TUNING $\triangleleft/\triangleright$.

See “Selecting preset stations” on page 56.

- 2** Press and hold EDIT for more than 3 seconds.

“E1” and the MEMORY indicator flash in the front panel display.

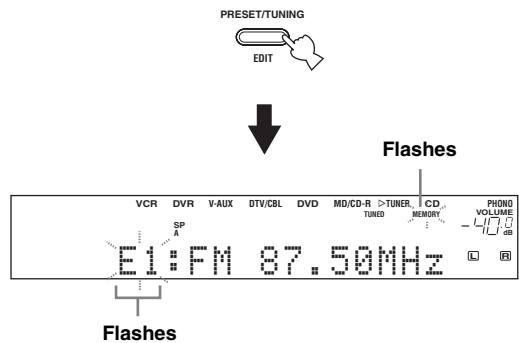

3 Select preset station “A5” using A/B/C/D/E and PRESET/TUNING </>.

“A5” and the MEMORY indicator flash in the front panel display.
See “Selecting preset stations” on page 56.

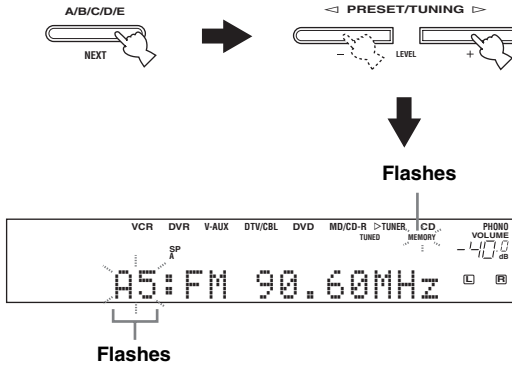

4 Press EDIT again.

“EDIT E1–A5” appears in the front panel display and the assignments of the two preset stations are exchanged.

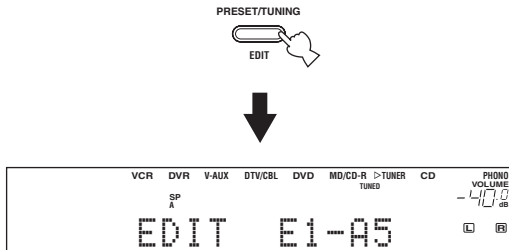

RADIO DATA SYSTEM TUNING (U.K. AND EUROPE MODELS ONLY)

Radio Data System (U.K. and Europe models only) is a data transmission system used by FM stations in many countries. The Radio Data System function is carried out among the network stations. This unit can receive various Radio Data System data such as PS (program service), PTY (program type), RT (radio text), CT (clock time), and EON (enhanced other networks) when receiving Radio Data System broadcasting stations.

Selecting the Radio Data System program

Use this feature to select one of the 15 Radio Data System program types and search for all the available preset stations of the selected program type.

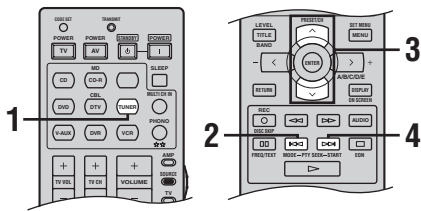

1 Press TUNER on the remote control to select “TUNER” as the input source.



2 Press PTY SEEK MODE on the remote control to set this unit to the PTY SEEK mode.

The name of the program type or “NEWS” flashes in the front panel display.

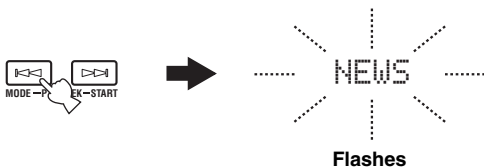

To cancel the PTY SEEK mode, press PTY SEEK MODE on the remote control again.

3 Press PRESET/CH ^ / v on the remote control to select the desired program type.
The name of the selected program type appears in the front panel display.

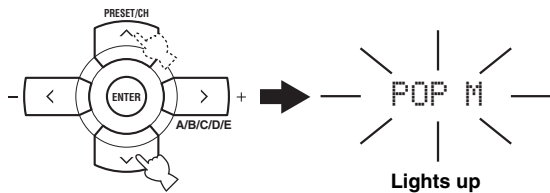

Program type	Descriptions
NEWS	News
AFFAIRS	Current affairs
INFO	General information
SPORT	Sports
EDUCATE	Education
DRAMA	Drama
CULTURE	Culture
SCIENCE	Science
VARIED	Light entertainment
POP M	Popular music
ROCK M	Rock music
M.O.R. M	Middle-of-the-road music (easy-listening)
LIGHT M	Light classics
CLASSICS	Serious classics
OTHER M	Other music

4 Press PTY SEEK START on the remote control to start searching for all the available Radio Data System preset stations.

The name of the selected program type flashes and the PTY HOLD indicator lights up in the front panel display while this unit is searching for stations.

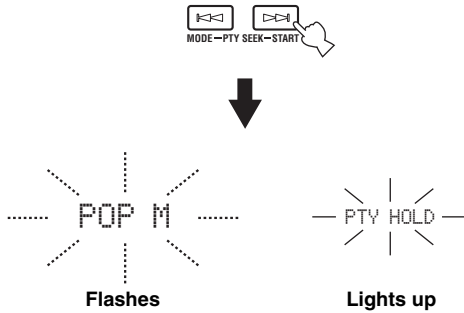

To stop searching for stations, press PTY SEEK START on the remote control again.

Notes

- This unit stops searching for stations when a station broadcasting the selected program type is found.
- If the station found is not the one you desire, press PTY SEEK START again to resume searching for another station broadcasting the same program type.

Using the Radio Data System station network

Use this feature to receive the EON (enhanced other networks) data service of the Radio Data System station network. Once you select one of the 4 Radio Data System program types (NEWS, AFFAIRS, INFO, or SPORT), this unit automatically searches for all the available preset stations that are scheduled to broadcast the EON data service of the selected program type for a certain duration of time. When the scheduled EON data service starts, this unit automatically switches to the local station broadcasting the EON data service and then switches back to the national station once the EON data service ends.

Notes

- You can use this feature only when the EON data service is available.
- The EON indicator lights up in the front panel display only when the EON data service is being received from a Radio Data System station.

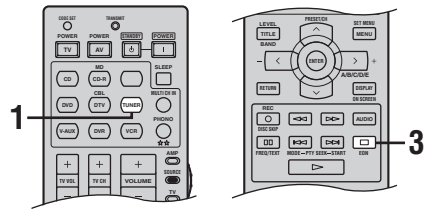

1 Press TUNER on the remote control to select "TUNER" as the input source.



2 Make sure the EON indicator is lit in the front panel display.

If the EON indicator is not lit in the front panel display, select another Radio Data System program so that the EON indicator lights up.

3 Press EON on the remote control repeatedly to select one of the 4 Radio Data System program types (NEWS, AFFAIRS, INFO or SPORT).

The name of the selected program type appears in the front panel display.

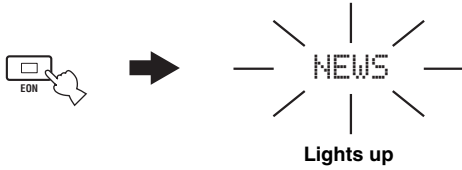

To cancel the EON feature, press EON on the remote control repeatedly until the name of the program type disappears and "EON OFF" appears in the front panel display.

Displaying the Radio Data System information

Use this feature to display the 4 types of the Radio Data System information: PS (program service), PTY (program type), RT (radio text) and CT (clock time). The corresponding indicators light up in the front panel display.

Notes

- You can select one of the Radio Data System modes only when the corresponding Radio Data System indicator lights up in the front panel display. It may take a while for this unit to receive all of the Radio Data System data from the station.
- You can select only the available Radio Data System modes being offered by the station.
- If the signals being received are not strong enough, this unit may not be able to utilize the Radio Data System data. In particular, the "RT" mode requires a large amount of data and may not be available even when the other Radio Data System modes are available.
- In case of poor reception conditions, press TUNING MODE (AUTO/MAN'L) on the front panel so that the AUTO indicator disappears from the front panel display.
- If the signal strength is weakened by external interference while this unit is receiving the Radio Data System data, the reception may be cut off unexpectedly and "...WAIT" appears in the front panel display.
- When the "RT" mode is selected, this unit can display the program information by a maximum of 64 alphanumeric characters, including the umlaut symbol. Unavailable characters are displayed with the "_" (underscore).
- If the reception is cut off when the "CT" mode is selected, "CT WAIT" appears in the front panel display.

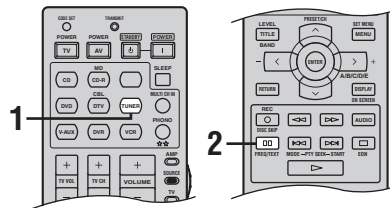

1 Press TUNER on the remote control to select "TUNER" as the input source.



- 2 Press FREQ/TEXT on the remote control repeatedly to select the desired Radio Data System display mode.**

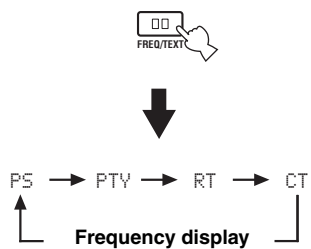

- Select “PS” to display the name of the Radio Data System program currently being received.
- Select “PTY” to display the type of the Radio Data System program currently being received.
- Select “RT” to display the information on the Radio Data System program currently being received.
- Select “CT” to display the current time.

SOUND FIELD PROGRAMS

What really creates the rich, full tones of a live instrument are the multiple reflections from the walls of the room. In addition to making the sound live, these reflections enable us to tell where the player is situated as well as the size and shape of the room in which we are sitting.

■ Elements of a sound field

There are two distinct types of sound reflections that combine to make up the sound field in addition to the direct sound coming straight to our ears from the player's instrument.

Early reflections

Reflected sounds reach our ears extremely rapidly (50 ms to 100 ms after the direct sound), after reflecting from one surface only (for example, from a wall or the ceiling). Early reflections actually add clarity to the direct sound.

Reverberations

These are caused by reflections from more than one surface (for example, from the walls, and the ceiling) so numerous that they merge together to form a continuous sonic afterglow. They are non-directional and lessen the clarity of the direct sound.

Direct sound, early reflections and subsequent reverberations taken together help us to determine the subjective size and shape of the room, and it is this information that the digital sound field processor reproduces in order to create sound fields.

If you could create the appropriate early reflections and subsequent reverberations in your listening room, you would be able to create your own listening environment. The acoustics in your room could be changed to those of a concert hall, a dance floor, or a room with virtually any size at all. This ability to create sound fields at will is exactly what YAMAHA has done with the digital sound field processor.

Selecting sound field programs

Notes

- Choose a sound field program based on your listening preference, not merely on the name of the program.
- When you select an input source, this unit automatically selects the last sound field program used with the corresponding input source.
- Sound field programs cannot be selected when the component connected to the MULTI CH INPUT jacks is selected as the input source (see page 44).
- Sampling frequencies higher than 48 kHz (except for DTS 96/24 signals) are sampled down to 48 kHz and then sound field programs are applied.

■ Front panel operations

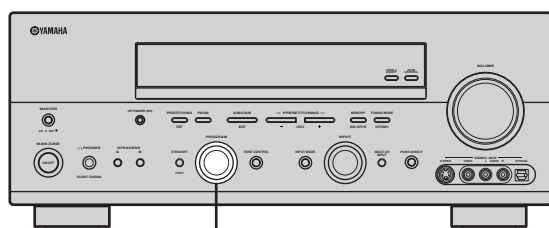

PROGRAM selector

Rotate the PROGRAM selector on the front panel.

The name of the selected sound field program appears in the front panel display and in the OSD.

■ Remote control operations

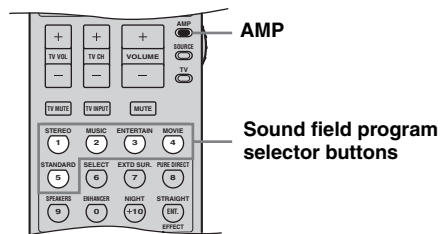

AMP

Sound field program selector buttons

Set the component selector switch to AMP and then press one of the sound field program selector buttons on the remote control repeatedly.

The name of the selected sound field program appears in the front panel display and in the OSD.

Sound field program descriptions

This unit is equipped with a variety of precise digital decoders that allow you to enjoy multi-channel playback from almost any stereo or multi-channel sound source. This unit is also equipped with a YAMAHA digital sound field processing (DSP) chip containing several sound field programs which you can use to enhance your playback experience.



The YAMAHA CINEMA DSP modes are compatible with all Dolby Digital, DTS, and Dolby Surround sources. Set “INPUT MODE” to “AUTO” (see page 41) to enable this unit to automatically switch to the appropriate digital decoder according to the input signal.

Notes

- The DSP sound field programs of this unit are recreations of real-world acoustic environments made from precise measurements taken in the actual concert hall, music venue, movie theater, etc. Thus, you may notice variations in the strength of the reflections coming from the front, back, left and right.
- Choose a sound field program based on your listening preference, not merely on the name of the program itself.

■ For movie/video sources

You can select from the following sound fields when playing movie or video sources. The sound fields marked “MULTI” can be used with multi-channel sources, like DVD, digital TV, etc. Those marked “2-CH” can be used with 2-channel stereo sources like TV programs, video tapes, etc.



Rotate the PROGRAM selector on the front panel (or set the component selector switch to AMP and then press one of the sound field program selector buttons on the remote control) to select the desired sound field program (see page 63).

Remote control button	Sound field program	Features	Sources
1	STEREO 2ch Stereo	Downmixes multi-channel sources to 2 channels or plays back 2-channel sources as they are.	
2	MUSIC Pop/Rock	CINEMA DSP processing. Creates an enthusiastic atmosphere where you can feel as if you are in an actual jazz or rock concert.	
3	ENTERTAINMENT TV Sports	CINEMA DSP processing. Reproduces the sound environment of a large concert hall using the surround sound field to enhance your experience of watching various TV programs such as news, variety shows, music programs or sports programs.	MULTI 2-CH
	ENTERTAINMENT Mono Movie	CINEMA DSP processing. Reproduces monaural video sources (such as old movies) at the optimum reverberation level to create sound depth using only the presence sound field.	
	ENTERTAINMENT Game	CINEMA DSP processing. Adds a deep and spatial feeling to video game sounds.	

Remote control button	Sound field program	Features	Sources
4	MOVIE THEATER Spectacle	CINEMA DSP processing. This program reproduces the extremely wide sound field of a 70-mm movie theater in detail, making both the video and the sound field incredibly real. This is ideal for any kind of video source encoded in Dolby Surround, Dolby Digital or DTS, especially large-scale movie productions.	MULTI 2-CH
	MOVIE THEATER Sci-Fi	CINEMA DSP processing. This program reproduces dialog and sound effects in the latest sound form for science fiction films, thus creating a broad and expansive cinematic space amid silence. You can enjoy science fiction films encoded in Dolby Surround, Dolby Digital or DTS in a virtual-space sound field employing the most advanced techniques.	
	MOVIE THEATER Adventure	CINEMA DSP processing. This program reproduces the sound design of the newest 70-mm and multi-channel soundtrack films similar to the sound field of the newest movie theaters, so the reverberations of the sound field itself are restrained as much as possible.	
	MOVIE THEATER General	CINEMA DSP processing. This program reproduces sounds from 70-mm and multi-channel soundtrack films characterized by soft and extensive sound field.	
5	SUR. STANDARD	Standard processing for the selected decoder.	
	SUR. ENHANCED	Enhanced processing for the selected decoder.	

■ For music sources

You can select from the following sound fields when playing music sources, like CD, FM/AM broadcasting, tapes, etc.



Rotate the PROGRAM selector on the front panel (or set the component selector switch to AMP and then press one of the sound field program selector buttons on the remote control) to select the desired sound field program (see page 63).

Remote control button	Sound field program	Features	Sources
1	STEREO 2ch Stereo	Plays back 2-channel sources.	2-CH
	STEREO 7ch Stereo	Plays back 2-channel sources from all speakers in 7.1 channels, providing a larger sound field ideal for background music at parties, etc.	
2	MUSIC Hall in Vienna	HiFi DSP processing. The program reproduces a classic shoe-box type concert hall with approximately 1700 seats. Pillars and ornate carvings create extremely complex reflections which produce a very full, rich sound.	MULTI 2-CH
	MUSIC The Btm Line	HiFi DSP processing. This program reproduces the stage front in "The Bottom Line", a famous New York jazz club where 300 people can be seated.	
	MUSIC The Roxy Thtr	HiFi DSP processing. This program reproduces the dynamic rock music environment of "The Roxy Theatre", one of the hottest rock clubs in L.A. The listener's imaginary seat is at the center-left of the hall.	
3	ENTERTAINMENT Disco	HiFi DSP processing. This program reproduces the acoustic environment of a lively disco in the heart of a big city to create a highly concentrated and energetic sound.	
5	SUR. STANDARD	Standard processing for the selected decoder.	
	SUR. ENHANCED	Enhanced processing for the selected decoder.	

Changing sound field parameter settings

You can enjoy good quality sound with the initial factory settings. Although you do not have to change the initial factory settings, you can change some of the parameters to better suit the input source or your listening room.

Notes

- Use the “PARAM. INT” feature in “OPTION MENU” to initialize the parameters of each sound field program within a sound field program group (see page 88).
- When you set a sound field parameter to a value other than the initial factory settings, an asterisk mark (*) appears by the sound field parameter name in the OSD.
- You cannot change the sound field parameter values when “MEMORY GUARD” in “OPTION MENU” is set to “ON” (see page 88). If you want to change the sound field parameter values, set “MEMORY GUARD” to “OFF”.



- For details about the function and control range of each sound field parameter, see page 67.
- Repeat steps 3 and 4 as necessary to change other sound field program parameter settings.
- The available sound field parameters for some of the sound field programs may be displayed on more than one page in the OSD. In this case, press ^ / v to scroll through pages.
- If you press and hold < / > to change the sound field parameter value, the initial factory settings are shown momentarily in the front panel display.

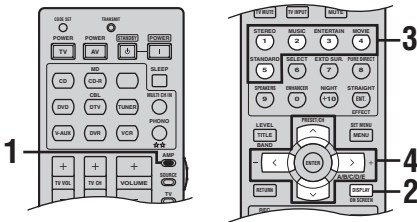

1 Set the component selector switch to AMP.



2 Turn on the video monitor and then press **DISPLAY** on the remote control.

The following display is shown in the OSD.

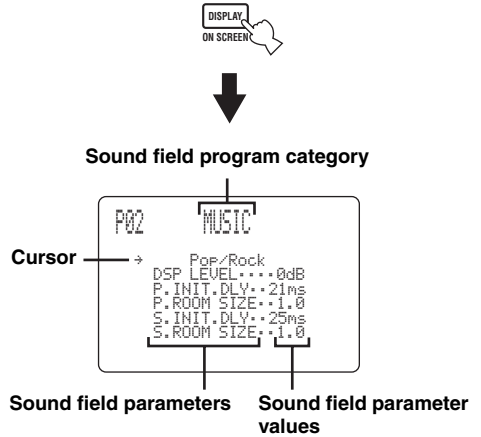

3 Press one of the sound field program selector buttons repeatedly to select the desired sound field program you want to adjust.

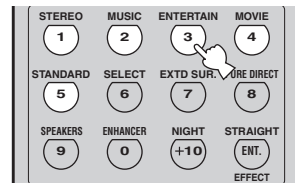

4 Press ^ / v to select the desired sound field parameter and then < / > to change the selected sound field parameter value.

- Press > to increase the value.
- Press < to decrease the value.

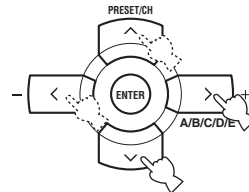

■ Sound field parameter descriptions

You can adjust the values of certain digital sound field parameters so that the sound fields are recreated accurately in your listening room. Not all of the following parameters are found in every program.



To change sound field parameter settings to suit your listening environment, see page 66 for details.

Sound field parameter	Features
DSP LEVEL	DSP level. Adjusts the level of all the DSP effect sounds within a narrow range. Depending on the acoustics of your listening room, you may want to increase or decrease the DSP effect level relative to the level of the direct sound. Control range: -6 dB to +3 dB
INIT.DLY P. INIT.DLY S. INIT.DLY SB INI.DLY	Initial delay. Presence, surround, and surround back initial delay. Changes the apparent distance from the source sound by adjusting the delay between the direct sound and the first reflection heard by the listener. The smaller the value, the closer the sound source seems to the listener. The larger the value, the farther it seems. For a small room, set to a small value. For a large room, set to a large value. Control range: 1 to 99 ms (INIT.DLY and P.INIT.DLY) 1 to 49 ms (S.INIT.DLY and SB INI.DLY)

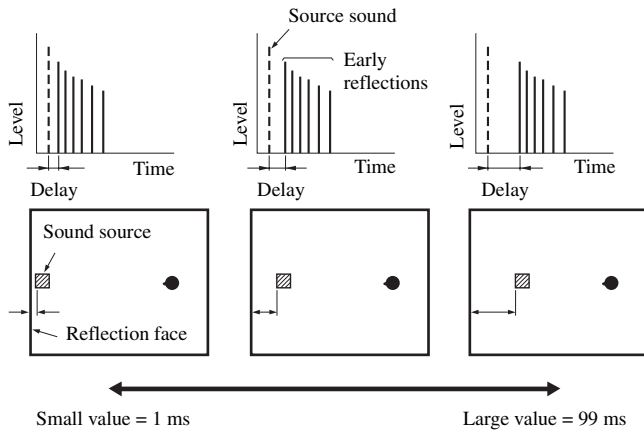

Sound field parameter	Features
-----------------------	----------

ROOM SIZE
 P.ROOM SIZE
 S.ROOM SIZE
 SB ROOM SIZE

Room size. Presence, surround, and surround back room size. Adjusts the apparent size of the surround sound field. The larger the value, the larger the surround sound field becomes. As the sound is repeatedly reflected around a room, the larger the hall is, the longer the time between the original reflected sound and the subsequent reflections. By controlling the time between the reflected sounds, you can change the apparent size of the virtual venue. Changing this parameter from one to two doubles the apparent length of the room.

Control range: 0.1 to 2.0

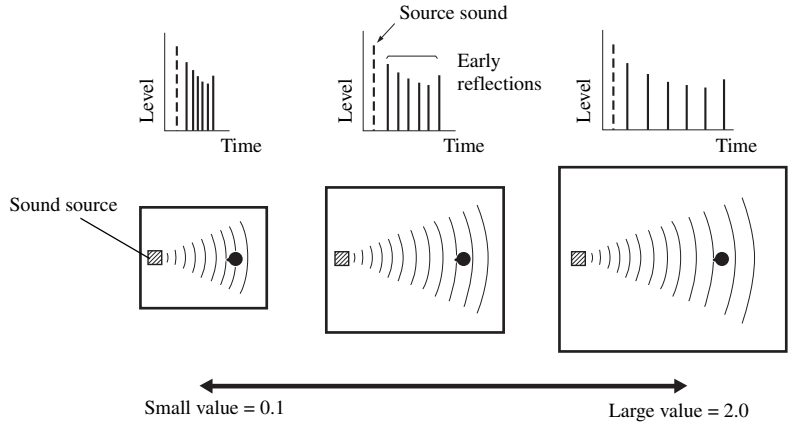

LIVENESS
 S.LIVENESS
 SB LIVENESS

Liveness. Surround and surround back liveness. Adjusts the reflectivity of the virtual walls in the hall by changing the rate at which the early reflections decay. The early reflections of a sound source decay much faster in a room with acoustically absorbent wall surfaces than in one which has highly reflective surfaces. A room with acoustically absorbent surfaces is referred to as “dead”, while a room with highly reflective surfaces is referred to as “live”. This parameter lets you adjust the early reflection decay rate and thus the “liveness” of the room.

Control range: 0 to 10

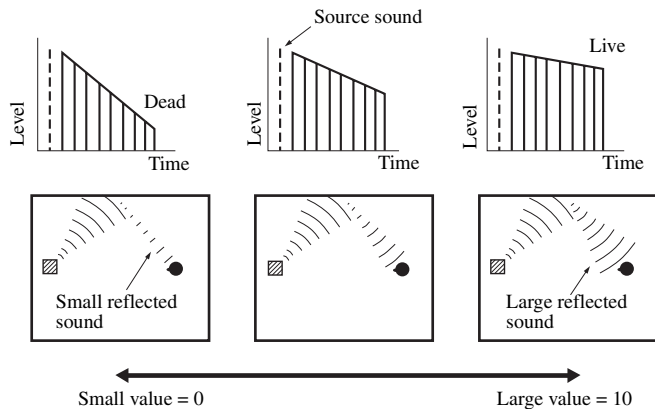

Sound field parameter	Features
-----------------------	----------

REV. TIME

Reverberation time. Adjusts the amount of time taken for the dense, subsequent reverberation sound to decay by 60 dB at 1 kHz. This changes the apparent size of the acoustic environment over an extremely wide range. Set a longer reverberation time for “dead” sources and listening room environments, and a shorter time for “live” sources and listening room environments.

Control range: 1.0 to 5.0 s

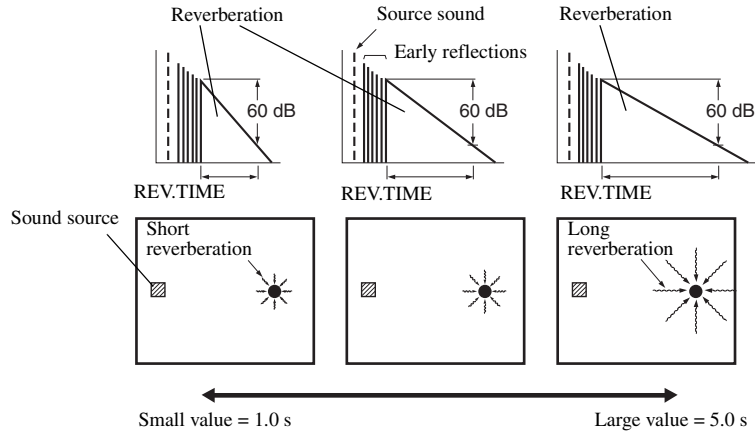

REV. DELAY

Reverberation delay. Adjusts the time difference between the beginning of the direct sound and the beginning of the reverberation sound. The larger the value, the later the reverberation sound begins. A later reverberation sound makes you feel as if you are in a larger acoustic environment.

Control range: 0 to 250 ms

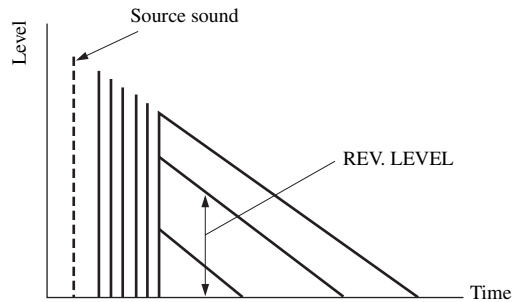

Sound field parameter	Features
REV. LEVEL	<p>Reverberation level. Adjusts the volume of the reverberation sound. The larger the value, the stronger the reverberation becomes.</p> <hr/> <p>Control range: 0 to 100%</p>
<p>The graph plots Level (dB) on the vertical axis against Time on the horizontal axis. It shows two distinct sound components: 'Source sound' and 'Reverberation'. The 'Source sound' is depicted as a series of vertical lines that decrease in height over time. The 'Reverberation' is shown as a single line that begins after a 'REV.DELAY' period and then decays linearly over a 'REV.TIME' period. A vertical double-headed arrow on the right side of the graph indicates that the total decay of the reverberation is 60 dB.</p>	
DIALG. LIFT	<p>Dialog lift. Adjust the height of the front and center channel sounds by assigning some of the front and center channel elements to the presence speakers. The larger the parameter, the higher the position of the front and center channel sound.</p> <hr/> <p>Choices: 0, 1, 2, 3, 4, 5</p>
2ch Stereo DIRECT	<p>2-channel stereo direct. Bypasses the decoders and DSP processors of this unit for pure hi-fi stereo sound when playing 2-channel analog sources.</p> <hr/> <p>Choices: AUTO, OFF</p>
<p>☀</p> <ul style="list-style-type: none"> • The “AUTO” setting bypasses the decoders and DSP processors only when “BASS” and “TREBLE” are set to 0 dB (see page 39). • When multi-channel signals (Dolby Digital and DTS) are input, they are downmixed to 2 channels and output from the front left and right speakers. • The low-frequency signals input from the front left and right speakers are redirected to the subwoofer in the following cases: <ul style="list-style-type: none"> – “LFE/BASS OUT” is set to “BOTH” (see page 81). – “FRONT SP” is set to “SMALL” (see page 79) and “LFE/BASS OUT” is set to “SWFR” (see page 81). 	
7ch Stereo CT LEVEL SL LEVEL SR LEVEL SB LEVEL PL LEVEL PR LEVEL	<p>7-channel stereo center, surround left, surround right, surround back, presence left and presence right levels. Adjusts the volume level of each channel in the 7-channel stereo mode.</p> <hr/> <p>Control range: 0 to 100%</p>

Sound field parameter	Features
PRO LOGIC IIx Music PRO LOGIC II Music PANORAMA	Pro Logic IIx Music and Pro Logic II Music panorama. Sends stereo signals to the surround speakers as well as the front speakers for a wraparound effect. Choices: OFF , ON
PRO LOGIC IIx Music PRO LOGIC II Music DIMENSION	Pro Logic IIx Music and Pro Logic II Music dimension. Adjusts the sound field either towards the front or towards the rear. Control range: -3 (towards the rear) to +3 (towards the front) Initial setting: STD (standard)
PRO LOGIC IIx Music PRO LOGIC II Music CENTER WIDTH	Pro Logic IIx Music and Pro Logic II Music center width. Moves the center channel output completely towards the center speaker or towards the front left and right speakers. A larger value moves the center channel output towards the front left and right speakers. Control range: 0 (center channel sound is output only from the center speaker) to 7 (center channel sound is output only from the front left and right speakers) Initial setting: 3
DTS Neo:6 Music C. IMAGE	DTS Neo:6 Music center image. Adjusts the front left and right channel output relative to the center channel to make the center channel more or less dominant as necessary. Control range: 0.0 to 1.0 Initial setting: 0.3

 The “PRO LOGIC IIx Music”, “PRO LOGIC II Music”, and “DTS Neo:6 Music” parameters can be set only when “SUR. STANDARD” is selected. Set the component selector switch to AMP and then press STANDARD on the remote control repeatedly to select “SUR. STANDARD” (see page 49).

Sound field program speaker layouts

Sound output from each speaker depends on the type of audio signals being input. Refer to the diagrams in the table below to understand the speaker layout for each sound field program.

Note

Be advised that there may be no or not enough sound output from speakers depending on the type of input source being played back. Furthermore, there may be some channels that can only be used partially when they are adjusted to specific aspects of movies, such as special sound effects, etc.



Except for “2ch Stereo”, “7ch Stereo”, and “STRAIGHT”, you can select a decoder to output sound from the surround back speakers (see page 48).

The abbreviations and symbols used in each diagram are as follows:

- L Front left speaker
- SL Surround left speaker
- SBR Surround back right speaker
- C Center speaker
- SR Surround right speaker
- PL Presence left speaker
- R Front right speaker
- SBL Surround back left speaker
- PR Presence right speaker
- Speaker from which sound is being output
- Speaker from which no sound is being output

*1 When the EX / PL IIX / ES indicators are turned off in the front panel display

*2 When the EX / PL IIX / ES indicators are lit up and “PRIORITY” is set to “PRch” (see page 81)

*3 When the EX / PL IIX / ES indicators are lit up and “PRIORITY” is set to “SBch” (see page 81)

Sound field program	2-channel audio (monaural)	2-channel audio (stereo)	5.1/6.1/7.1-channel audio *1	5.1/6.1/7.1-channel audio *2	5.1/6.1/7.1-channel audio *3
STEREO 2ch Stereo					
STEREO 7ch Stereo					
MUSIC Hall in Vienna The Btm Line The Roxo Thtr ENTERTAINMENT Disco					

Sound field program	2-channel audio (monaural)	2-channel audio (stereo)	5.1/6.1/7.1-channel audio *1	5.1/6.1/7.1-channel audio *2	5.1/6.1/7.1-channel audio *3
MUSIC Pop/Rock ENTERTAINMENT TV Sports Mono Movie Game					
MOVIE THEATER Spectacle Sci-Fi Adventure General					
SUR. STANDARD DOLBY DIGITAL PRO LOGIC DTS					
	Pro Logic	Pro Logic			
SUR. STANDARD PLII Movie PLII Music PLII Game PLIIx Movie PLIIx Music PLIIx Game					
	Movie/Game	Pro Logic II			
	Music	Pro Logic IIx			
SUR. STANDARD Neo:6 Cinema Neo:6 Music					
	Cinema	Cinema/Music			
	Music				

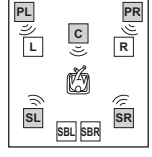
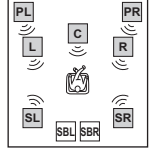
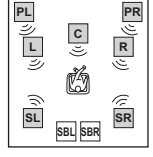
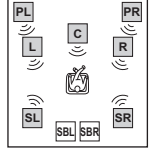
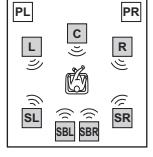
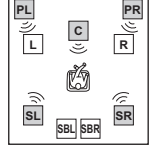
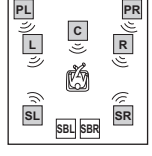
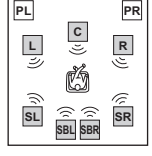
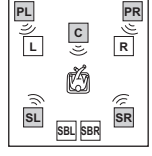
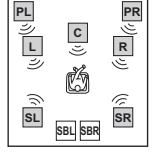
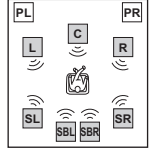
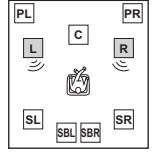
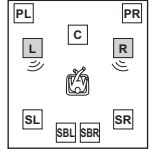
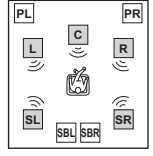
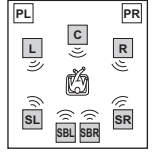
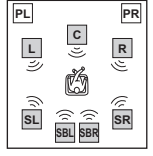
Sound field program	2-channel audio (monaural)	2-channel audio (stereo)	5.1/6.1/7.1-channel audio *1	5.1/6.1/7.1-channel audio *2	5.1/6.1/7.1-channel audio *3
SUR. ENHANCED DOLBY DIGITAL PRO LOGIC DTS					
	Pro Logic				
SUR. ENHANCED PLII Movie PLIIx Movie					
			When "PRIORITY" is set to "PRch"		
					
			When "PRIORITY" is set to "SBch"		
SUR. ENHANCED Neo:6 Cinema					
			When "PRIORITY" is set to "PRch"		
					
			When "PRIORITY" is set to "SBch"		
STRAIGHT					
	Monaural playback				

Sound field program	2-channel audio (monaural)	2-channel audio (stereo)	5.1/6.1/7.1-channel audio *1	5.1/6.1/7.1-channel audio *2	5.1/6.1/7.1-channel audio *3
---------------------	----------------------------	--------------------------	------------------------------	------------------------------	------------------------------

Pure Direct

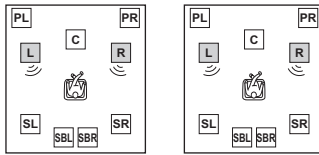

Monaural playback

SET MENU

You can use the following parameters in “SET MENU” to adjust a variety of system settings and customize the way this unit operates. Change the initial settings (indicated in bold under each parameter) to reflect the needs of your listening environment.

■ **Auto setup** AUTO SETUP

Use this feature to automatically adjust speaker and system parameters (see page 32).

■ **Manual setup** MANUAL SETUP

Use this feature to manually adjust speaker and system parameters.

Sound menu 1 SOUND MENU

Use this menu to manually adjust any speaker settings, alter the quality and tone of the sound output by the system or compensate for video signal processing delays when using LCD monitors or projectors.

Parameter	Features	Page
A)SPEAKER SET	Selects the size of each speaker, the speakers for low-frequency signal output, and the crossover frequency.	79
B)SPEAKER LEVEL	Adjusts the output level of each speaker.	82
C)SP DISTANCE	Adjusts the delay time of each speaker.	82
D)EQUALIZER	Adjusts the tonal quality of the center speaker.	83
E)LFE LEVEL	Adjusts the output level of the LFE channel for Dolby Digital or DTS signals.	84
F)DYNAMIC RANGE	Adjusts the dynamic range of Dolby Digital or DTS signals.	84
G)AUDIO SET	Adjusts the muting level, audio delay and tone bypass settings.	84

Input menu 2 INPUT MENU

Use this menu to manually reassign the input/output jacks, select the input mode or rename the input source.

Parameter	Features	Page
A)I/O ASSIGNMENT	Assigns the input/output jacks of this unit according to the component to be used.	85
B)INPUT MODE	Selects the initial input mode of the source.	86
C)INPUT RENAME	Changes the name of the input source.	86
D)VOLUME TRIM	Adjusts the output volume of each jack.	87

Option menu 3 OPTION MENU

Use this menu to manually adjust the optional system parameters.

Parameter	Features	Page
A)DISPLAY SET	Adjusts the brightness of the display and converts video signals.	87
B)MEMORY GUARD	Locks sound field program parameters and other "SET MENU" settings.	88
C)PARAM. INI	Initializes the parameters of a group of sound field programs.	88
D)MULTI ZONE SET	Specifies the location of the speakers connected to the SPEAKERS B terminals or selects how the ZONE 2 speakers will be amplified.	89

■ **Signal information** SIGNAL INFO

Use this feature to check audio signal information (see page 46).

Using SET MENU

Use the remote control to access and adjust each parameter.

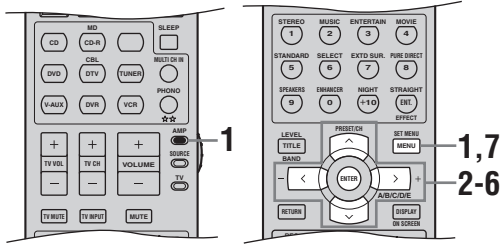

- You can change the “SET MENU” parameters while this unit is reproducing sound.
- If you press one of the sound field program selector buttons during the “SET MENU” operation, the “SET MENU” operation is canceled.
- Repeat the following procedure to select and adjust each parameter setting.
- Press RETURN to return to the previous menu level.

Note

You cannot change some “SET MENU” parameters when “NIGHT:CINEMA” or “NIGHT:MUSIC” is selected as the night listening mode (see page 40).

1 Set the component selector switch to AMP and then press SET MENU to enter “SET MENU”.

The top “SET MENU” display appears in the OSD.

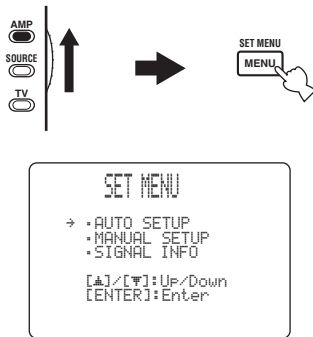

2 Press ^/∨ to select “MANUAL SETUP”.

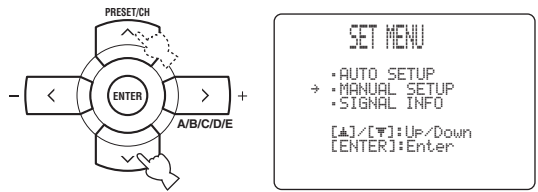

3 Press ENTER to enter “MANUAL SETUP”.

The “MANUAL SETUP” display appears in the OSD.

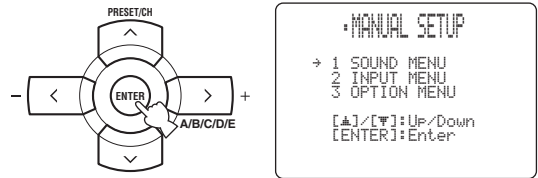

4 Press ^/∨ repeatedly and then press ENTER to select and enter the desired menu.

The following displays are examples where “SOUND MENU” is selected.

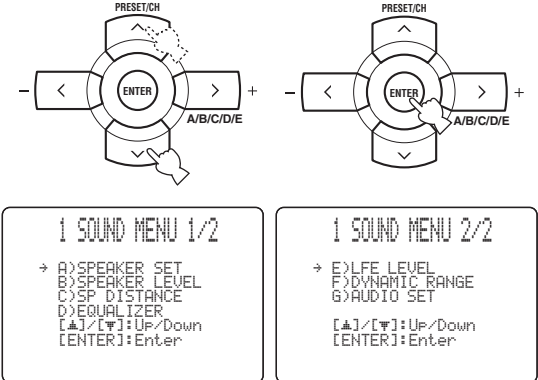

5 Press \wedge / \vee repeatedly and then press ENTER to select and enter the desired submenu.

The following display is an example where "SPEAKER LEVEL" is selected.

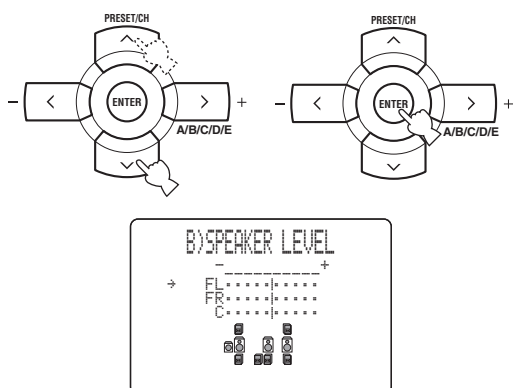

6 Press \wedge / \vee to select the desired parameter and then \langle / \rangle to change the parameter settings.

- Press \rangle to increase the value.
- Press \langle to decrease the value.

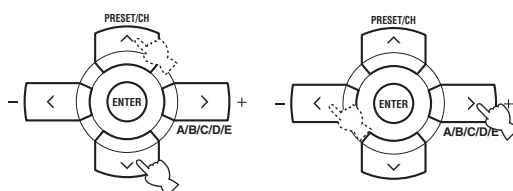

7 Press SET MENU to exit from "SET MENU".



Memory back-up

The memory back-up circuit prevents the stored data from being lost even if this unit is in the standby mode. However, the stored data will be lost in case the power cable is disconnected from the AC wall outlet or if the power supply is cut off for more than one week.

1 SOUND MENU

Use this menu to manually adjust any speaker settings or compensate for video signal processing delays when using LCD monitors or projectors.

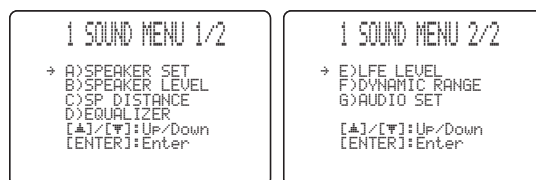

■ Speaker settings A) SPEAKER SET

Use this feature to manually adjust any speaker settings.



If you are not satisfied with the bass sounds from your speakers, you can change these settings according to your preference.

Front speakers FRONT SP

Choices: SMALL, LARGE

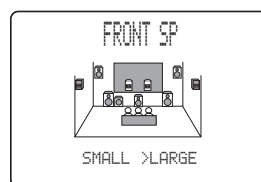

- Select "SMALL" (small) if you have small front speakers that do not reproduce low-frequency signals effectively. The low-frequency signals of the front left and right channels are directed to the speakers selected in "LFE/BASS OUT" (see page 81).
- Select "LARGE" (large) if you have large front speakers that reproduce low-frequency signals effectively. All the front left and right channel signals are directed to the front left and right speakers.

Note

If "LFE/BASS OUT" is set to "FRNT" (see page 81), the LFE signals found in Dolby Digital or DTS sources, the low-frequency signals of the front left and right channels, and the low-frequency signals of other speakers set to "SML" (or "SMALL") or to "NONE" are all directed to the front left and right speakers regardless of the "FRONT SP" setting.

Center speaker CENTER SP

Choices: NONE, **SML**, LRG

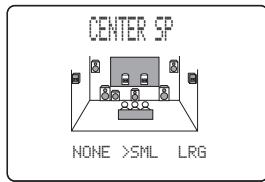

- Select “NONE” (none) if you did not connect a center speaker. The low-frequency signals of the center channel are directed to the speakers selected in “LFE/BASS OUT”, and the rest of the center channel signals are directed to the front left and right speakers.
- Select “SML” (small) if you have a small center speaker that does not reproduce low-frequency signals effectively. The low-frequency signals of the center channel are directed to the speakers selected in “LFE/BASS OUT”.
- Select “LRG” (large) if you have a large center speaker that reproduces low-frequency signals effectively. All the center channel signals are directed to the center speaker.

Surround left/right speakers SUR. L/R SP

Choices: NONE, **SML**, LRG

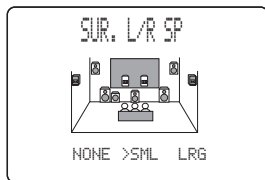

- Select “NONE” (none) if you did not connect surround speakers. This unit is set to the Virtual CINEMA DSP mode (see page 50) and “SUR. B L/R SP” is automatically set to “NONE”. The low-frequency signals of the surround left and right channels are directed to the speakers selected in “LFE/BASS OUT”.
- Select “SML” (small) if you have small surround left and right speakers that do not reproduce low-frequency signals effectively. The low-frequency signals of the surround left and right channels are directed to the speakers selected in “LFE/BASS OUT”.
- Select “LRG” (large) if you have large surround left and right speakers that reproduce low-frequency signals effectively. All the surround channel signals are directed to the surround left and right speakers.

Surround back speakers SUR. B L/R SP

Choices: NONE, SMLx1, **SMLx2**, LRGx1, LRGx2

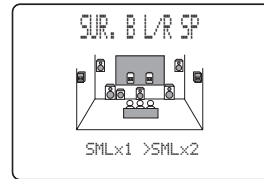

- Select “NONE” (none) if you did not connect surround back speakers. The low-frequency signals of the surround back channel are directed to the speakers selected in “LFE/BASS OUT”, and the rest of the surround back channel signals are directed to the surround left and right speakers.
- Select “SMLx1” (small x 1) if you have a small surround back speaker that does not reproduce low-frequency signals effectively. The low-frequency signals of the surround back left and right channels are directed to the speakers selected in “LFE/BASS OUT” and the rest of the signals are directed to the surround back left speaker.
- Select “SMLx2” (small x 2) if you have two small surround back speakers that do not reproduce low-frequency signals effectively. The low-frequency signals of the surround back left and right channels are directed to the speakers selected in “LFE/BASS OUT”.
- Select “LRGx1” (large x 1) if you have a large surround back speaker that reproduces low-frequency signals effectively. All the surround back left and right channel signals are directed to the surround back left speaker.
- Select “LRGx2” (large x 2) if you have two large surround back speakers that reproduce low-frequency signals effectively. All the surround back left and right channel signals are directed to the surround back left and right speakers.

Presence speakers PRESENCE SP

Use this feature if you want to use the presence speakers connected to this unit.

Choices: **NONE**, YES



- Select “NONE” (none) if you did not connect presence speakers.
- Select “YES” (yes) if you connected presence speakers and want to use them.

Bass out LFE/BASS OUT

Use this feature to select the speakers that output the LFE (low-frequency effect) and the low-frequency signals.

Choices: SWFR, FRNT, **BOTH**

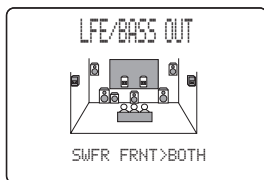

- Select “SWFR” (subwoofer) if you connected a subwoofer. The LFE signals as well as the low-frequency signals of other speakers set to “SML” (or “SMALL”) or to “NONE” are directed to the subwoofer.
- Select “FRNT” (front) if you did not connect a subwoofer. The LFE signals, the low-frequency signals of the front left and right channels, and the low-frequency signals of other speakers set to “SML” (or “SMALL”) or to “NONE” are all directed to the front left and right speakers regardless of the “FRONT SP” setting (see page 79).
- Select “BOTH” (both) if you connected a subwoofer. The low-frequency signals of any source are output from the subwoofer. The LFE signals as well as the low-frequency signals of other speakers set to “SML” (or “SMALL”) or to “NONE” are directed to the subwoofer. The low-frequency signals of the front left and right channels are directed to the front left and right speakers and the subwoofer regardless of the “FRONT SP” setting (see page 79).

Crossover CROSS OVER

Use this feature to select a crossover frequency of all the speakers set to “SML” (or “SMALL”) or to “NONE” in “SPEAKER SET” (see pages 79 and 80). All frequencies below the selected frequency will be sent to the subwoofer or to the speakers set to “LRG” (or “LARGE”) in “SPEAKER SET” (see pages 79 and 80).

Choices: 40Hz, 60Hz, **80Hz**, 90Hz, 100Hz, 110Hz, 120Hz, 160Hz, 200Hz

**Subwoofer phase** SUBWOOFER PHASE

Use this feature to switch the phase of your subwoofer if bass sounds are lacking or unclear.

Choices: **NORMAL**, REVERSE

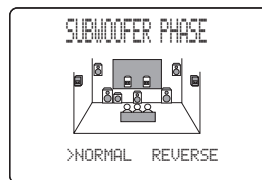

- Select “NORMAL” if you do not want to reverse the phase of your subwoofer.
- Select “REVERSE” to reverse the phase of your subwoofer.

Presence/Surround back channel priority PRIORITY

Use this feature to prioritize either the presence or the surround back speakers when playing sources that contain surround back channel signals using the CINEMA DSP sound field programs.

Choices: PRch, **SBch**

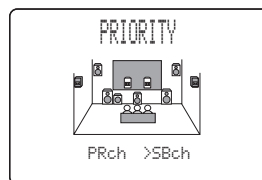

- Select “PRch” to use the presence speakers even when surround back channel signals are input. The signals for the surround back channel will be output from the surround speakers.
- Select “SBch” to use the surround back speakers when a surround back channel signals is detected in a CINEMA DSP program. The presence channel signals are output from the front speakers.

■ **Speaker level** B)SPEAKER LEVEL

Use this feature to manually balance the speaker levels between the front left or surround left speakers and each speaker selected in "SPEAKER SET" (see page 79).

Control range: -10.0 to +10.0 dB

Control step: 0.5 dB

Initial setting: 0 dB

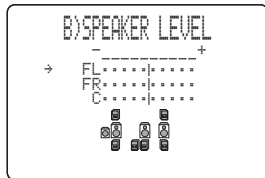

- Select "FL" to adjust the balance of the front left speaker.
- Select "FR" to adjust the balance of the front right speaker.
- Select "C" to adjust the balance of the center speaker.
- Select "SL" to adjust the balance of the surround left speaker.
- Select "SR" to adjust the balance of the surround right speaker.
- Select "SBL" to adjust the balance of the surround back left speaker.
- Select "SBR" to adjust the balance of the surround back right speaker.
- Select "SWFR" to adjust the balance of the subwoofer.
- Select "PL" to adjust the balance of the presence left speaker.
- Select "PR" to adjust the balance of the presence right speaker.

Notes

- "C", "SL", "SR", "SBL", "SBR", "SWFR", "PL" and "PR" cannot be adjusted if "CENTER SP" (see page 80), "SUR. L/R SP" (see page 80), "SUR. B L/R SP" (see page 80), "LFE/BASS OUT" (see page 81) and "PRESENCE SP" (see page 80) are set to "NONE" respectively.
- Instead of "SBL" and "SBR", "SB" is displayed if "SUR. B L/R SP" is set to either "SMLx1" or "LRGx1" (see page 80).

■ **Speaker distance** C)SP DISTANCE

Use this feature to manually adjust the distance of each speaker and the delay applied to the respective channel. Ideally, each speaker should be the same distance from the main listening position. However, this is not possible in most home situations. Thus, a certain amount of delay must be applied to the sound from each speaker so that all sounds will arrive at the listening position at the same time.

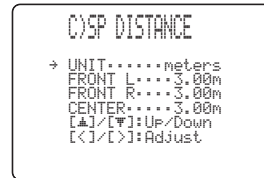

Unit UNIT

Choices: **meters** (m), feet (ft)

Initial setting:

[U.S.A. and Canada models]: feet (ft)

[Other models]: meters (m)

- Select "meters" to adjust speaker distances in meters.
- Select "feet" to adjust speaker distances in feet.

Speaker distances

Control range: 0.30 to 24.00 m (1.0 to 80.0 ft)

Control step: 0.10 m (0.5 ft)

- Select "FRONT L" to adjust the distance of the front left speaker.
Initial setting: 3.00 m (10.0 ft)
- Select "FRONT R" to adjust the distance of the front right speaker.
Initial setting: 3.00 m (10.0 ft)
- Select "CENTER" to adjust the distance of the center speaker.
Initial setting: 3.00 m (10.0 ft)
- Select "SUR. L" to adjust the distance of the surround left speaker.
Initial setting: 3.00 m (10.0 ft)
- Select "SUR. R" to adjust the distance of the surround right speaker.
Initial setting: 3.00 m (10.0 ft)
- Select "SB L" to adjust the distance of the surround back left speaker.
Initial setting: 2.10 m (7.0 ft)
- Select "SB R" to adjust the distance of the surround back right speaker.
Initial setting: 2.10 m (7.0 ft)
- Select "SWFR" to adjust the distance of the subwoofer.
Initial setting: 3.00 m (10.0 ft)
- Select "PRNS L" to adjust the distance of the presence left speaker.
Initial setting: 3.00 m (10.0 ft)
- Select "PRNS R" to adjust the distance of the presence right speaker.
Initial setting: 3.00 m (10.0 ft)

Notes

- “CENTER”, “SUR. L”, “SUR. R”, “SB L”, “SB R”, “SWFR”, “PRNS L” and “PRNS R” cannot be adjusted if “CENTER SP” (see page 80), “SUR. L/R SP” (see page 80), “SUR. B L/R SP” (see page 80), “LFE/BASS OUT” (see page 81) and “PRESENCE SP” (see page 80) are set to “NONE” respectively.
- Instead of “SB L” and “SB R”, “SUR. B” is displayed if “SUR. B L/R SP” is set to either “SMLx1” or “LRGx1” (see page 80).

Center graphic equalizer D)EQUALIZER

Use this feature to select the parametric equalizer or the graphic equalizer.

Equalizer select EQ TYPE SELECT

Use this feature to select the type of equalizer.

Choices: AUTO PEQ, **CENTER GEQ**, EQ OFF

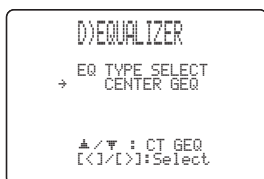

- Select “AUTO PEQ” to use the parametric equalizer adjusted in “AUTO SETUP” (see page 32).
- Select “CENTER GEQ” to adjust the built-in 5-frequency band graphic equalizer for the center speaker so that the tonal quality of the center speaker matches that of the front left and right speakers.
- Select “EQ OFF” to deactivate the equalizing feature.

Notes

- “AUTO PEQ” is automatically selected when you run “AUTO SETUP” (see page 32).
- If you press ^ / v while “CENTER GEQ” is selected, the OSD changes to the following screen.

Center graphic equalizer CENTER GEQ

When you select “CENTER GEQ” in “EQ TYPE SELECT”, use this feature to adjust the built-in 5-frequency band (100Hz, 300Hz, 1kHz, 3kHz and 10kHz) graphic equalizer for the center channel so that the tonal quality of the center speaker matches that of the front left and right speakers. You can make adjustments while listening to the currently selected source component or a test tone.

Control range: -6.0 to +6.0 dB

Control step: 0.5 dB

Initial setting: 0.0 dB

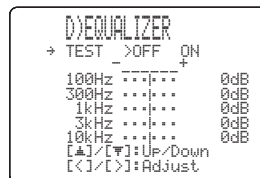

Press ^ / v to select a frequency band and < / > to adjust the selected frequency band.

Test tone TEST

Use this feature to make adjustments of “CENTER GEQ” while listening to a test tone.

Choices: **OFF**, ON

- Select “OFF” to stop test tones and output the currently selected source component.
- Select “ON” to output test tones from the front left and center speakers, and adjust the tonal quality of the center speaker.

■ Low-frequency effect level E>LFE LEVEL

Use this feature to adjust the output level of the LFE (low-frequency effect) channel according to the capacity of your subwoofer or headphones. The LFE channel carries low-frequency special effects which are only added to certain scenes. This setting is effective only when this unit decodes Dolby Digital or DTS signals.

Control range: -20 to **0** dB

Control step: 1 dB



Speaker SPEAKER

Adjusts the speaker LFE level.

Headphone HEADPHONE

Adjusts the headphone LFE level.

Note

Depending on the settings of “LFE/BASS OUT” (see page 81), some signals may not be output at the SUBWOOFER OUTPUT jack.

■ Dynamic range F>DYNAMIC RANGE

Use this feature to select the amount of dynamic range compression to be applied to your speakers or headphones. This setting is effective only when this unit is decoding Dolby Digital and DTS signals.

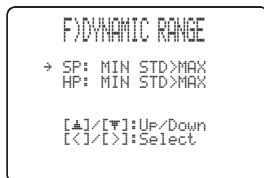

Speaker SP

Adjusts the speaker compression.

Headphone HP

Adjusts the headphone compression.

Choices: MIN, STD, **MAX**

- Select “MIN” (minimum) if you regularly listen at low volume levels.
- Select “STD” (standard) for general use.
- Select “MAX” (maximum) to preserve the greatest amount of dynamic range.

■ Audio settings G>AUDIO SET

Use this feature to adjust the overall audio settings of this unit.



Muting type MUTING TYPE

Use this feature to adjust how much the mute function reduces the output volume (see page 40).

Choices: **FULL**, -20dB

- Select “FULL” to completely mute all the audio output.
- Select “-20dB” to reduce the current volume by 20 dB.

Audio delay AUDIO DELAY

Use this feature to delay the sound output and synchronize it with the video image. This may be necessary when using certain LCD monitors or projectors.

Control range: **0** to 160 ms

Control step: 1 ms

Tone bypass TONE BYPASS

Use this feature to select whether audio output bypasses tone control circuitry when “TREBLE” and “BASS” are set to 0 dB (see page 39).

Choices: **AUTO**, OFF

- Select “AUTO” if you want signals to bypass tone control circuitry to provide the purest signal possible.
- Select “OFF” if you do not want signals to bypass tone control circuitry.

2 INPUT MENU

Use this menu to reassign the input/output jacks, select the input mode or rename the input source.

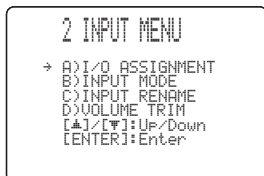

■ Input/output assignment

A) I/O ASSIGNMENT

Use this feature to assign the input/output jacks according to the component to be used if the initial settings of this unit do not correspond to your needs. Change the following parameters to reassign the respective jacks and effectively connect more components.

Once the input/output jacks are reassigned, you can select the corresponding component by using the INPUT selector on the front panel (or the input selector buttons on the remote control).

For COMPONENT VIDEO jacks A, B and C

```

CMPNT-V INPUT [A]
CMPNT-V INPUT [B]
CMPNT-V INPUT [C]
  
```

Choices: [A] **DVD**, DTV/CBL, V-AUX, VCR, DVR
 [B] DVD, **DTV/CBL**, V-AUX, VCR, DVR
 [C] DVD, DTV/CBL, V-AUX, VCR, **DVR**

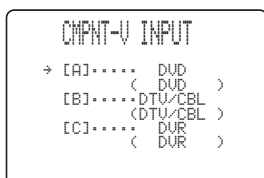

For OPTICAL OUTPUT jack 1 OPTICAL OUT (1)

Choices: PHONO, CD, **MD/CD-R**, DVD, DTV/CBL, V-AUX, VCR, DVR

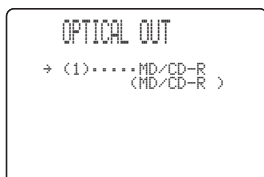

For OPTICAL INPUT jacks 2, 3 and 4

```

OPTICAL IN (2)
OPTICAL IN (3)
OPTICAL IN (4)
  
```

Choices: (2) PHONO, CD, **MD/CD-R**, DVD, DTV/CBL, VCR, DVR
 (3) PHONO, CD, MD/CD-R, **DVD**, DTV/CBL, VCR, DVR
 (4) PHONO, CD, MD/CD-R, DVD, **DTV/CBL**, VCR, DVR

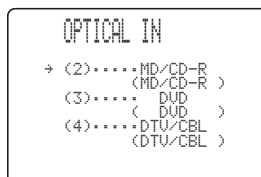

For COAXIAL INPUT jacks 5 and 6

```

COAXIAL IN (5)
COAXIAL IN (6)
  
```

Choices: (5) PHONO, **CD**, MD/CD-R, DVD, DTV/CBL, V-AUX, VCR, DVR
 (6) PHONO, CD, MD/CD-R, **DVD**, DTV/CBL, V-AUX, VCR, DVR

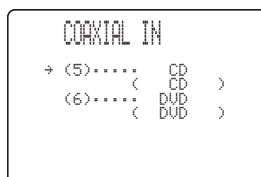

Notes

- You cannot select a specific item more than once for the same type of jack.
- When you connect a component to both the DIGITAL INPUT (COAXIAL) and DIGITAL INPUT (OPTICAL) jacks, priority is given to the signals input at the DIGITAL INPUT (COAXIAL) jack.

Input mode B)INPUT MODE

Use this feature to set this unit to reset “INPUT MODE” back to “AUTO” (see page 41) regardless of the previous setting or to recall the last input mode (“AUTO”, “DTS” or “ANALOG”) used for that source whenever you turn on this unit.

Choices: **AUTO**, **LAST**



- Select “AUTO” to reset “INPUT MODE” back to “AUTO” (see page 41) regardless of the previous setting whenever you turn on this unit. This unit automatically selects input signals in the following order:
 (1) Digital signals
 (2) Analog signals
- Select “LAST” to set this unit to automatically recall the last input mode (“AUTO”, “DTS” or “ANALOG”) used for that source whenever you turn on this unit.

Input rename C)INPUT RENAME

Use this feature to change the name of the input source that appears in the OSD and in the front panel display.



- 1 Press one of the input selector buttons on the remote control to select the input source you want to change the name of.

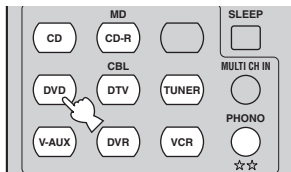

- 2 Set the component selector switch to AMP and then press </> on the remote control to place the “_” (underscore) under the space or the character you want to edit.

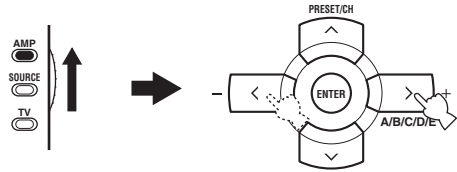

- 3 Press ^ / v to select the character you want to use and then press </> to move to the next space.

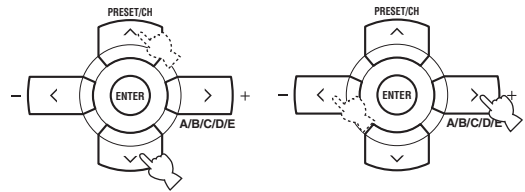

Notes

- You can use up to 8 characters for each input.
- Press v to change the character in the following order, or press ^ to go in the reverse order:
 A to Z, a space, 0 to 9, a space, a to z, a space, symbols (#, *, -, +, etc.)

- 4 Repeat steps 1 through 3 to rename each input source.

- 5 Press SET MENU on the remote control to exit from “INPUT RENAME”.



■ Volume Trim D)VOLUME TRIM

Use this feature to adjust the level of the signal input at each jack. This is useful if you want to balance the level of each input source to avoid sudden changes in volume when switching between input sources.

Choices: PHONO, CD, MD/CD-R, TUNER, DVD, DTV/CBL, V-AUX, VCR, DVR

Control range: -6.0 to +6.0 dB

Control step: 0.5 dB

Initial setting: 0.0 dB

```
D)VOLUME TRIM

DVD -> 0.0dB

[<]/[>]:Adjust
[RETURN]:Exit
```

3 OPTION MENU

Use this menu to adjust the optional system parameters.

```
3 OPTION MENU

-> A)DISPLAY SET
   B)MEMORY GUARD
   C)PARAM. INI
   D)MULTI ZONE SET
   [▲]/[▼]:Up/Down
   [ENTER]:Enter
```

■ Display settings A)DISPLAY SET

```
A)DISPLAY SET

-> DIMMER.....0
   VIDEO CONV....ON
   OSD SHIFT.....0
   GRAY BACK...AUTO

[▲]/[▼]:Up/Down
[<]/[>]:Select
```

Dimmer DIMMER

Use this feature to adjust the brightness of the front panel display.

Control range: -4 to 0

Control step: 1

- Press < to make the front panel display dimmer.
- Press > to make the front panel display brighter.

Video conversion VIDEO CONV.

Use this feature to set whether to convert the video signals input at the VIDEO and S VIDEO jacks.

Choices: **ON**, OFF

- Select "ON" to convert composite and S-video signals interchangeably and up-convert composite and S-video signals to component video signals.
- Select "OFF" not to convert any signals.

Notes

- The converted video signals are only output at the MONITOR OUT jacks. When recording a video source, you must make the same type of video connections between each component.
- When composite video or S-video signals from a VCR are converted to component video signals, the picture quality may suffer depending on your VCR.
- You must set "VIDEO CONV." to "ON" to display the OSD.
- Unconventional signals input at the composite video or S-video jacks cannot be converted or may be output abnormally. In such cases, set "VIDEO CONV." to "OFF".

OSD shift OSD SHIFT

Use this feature to adjust the vertical position of the OSD.

Control range: -5 (upward) to +5 (downward)

Control step: 1

Initial setting: 0

- Press < to raise the position of the OSD.
- Press > to lower the position of the OSD.

Gray back GRAY BACK

Use this feature to display a gray background in the OSD when there is no video signal being input.

Choices: **AUTO**, OFF

- Select "AUTO" to display a gray background in the OSD when there is no video signal being input.
- Select "OFF" not to display any background in the OSD.

Notes

- Depending on the video signals being input or the system setting of your video monitor (NTSC or PAL), the OSD may be displayed abnormally. In such cases, set "GRAY BACK" to "OFF".
- Even when "GRAY BACK" is set to "OFF", the OSD may not be displayed correctly depending on the conditions of the picture.

■ **Memory guard** B)MEMORY GUARD

Use this feature to prevent accidental changes to DSP program parameter values and other system settings.

Choices: **OFF**, ON



- Select "OFF" to turn off the "MEMORY GUARD" feature.
- Select "ON" to protect:
 - DSP program parameters
 - all "SET MENU" items
 - all speaker levels

Note

When "MEMORY GUARD" is set to "ON", you cannot select and adjust any other "SET MENU" items.

■ **Parameter initialization** C)PARAM. INI

Use this feature to initialize the parameters of each sound field program within a sound field program group. When you initialize a sound field program group, all of the parameter values within that group revert to their initial factory settings.

Press the corresponding sound field program selector buttons on the remote control to select the sound field program that you want to initialize.

An asterisk (*) appears to the left of the sound field program names that have been changed from their initial factory settings.

Choices: STEREO, MUSIC, ENTERTAINMENT, MOVIE THEATER, STANDARD



Notes

- You cannot automatically revert to the previous parameter settings once you initialize a sound field program group.
- You cannot separately initialize individual sound field programs.
- You cannot initialize any sound field program groups when "MEMORY GUARD" is set to "ON" (see page 88).

■ Zone set D)MULTI ZONE SET

Use this feature to specify the location of speakers connected to the SPEAKERS B terminals of this unit.

Speaker B setting SP B

Use this feature to select the location of the front speakers connected to the SPEAKERS B terminals.

Choices: **FRONT**, **ZONE B**



- Select “FRONT” to turn on or off SPEAKERS A and B when the speakers connected to the SPEAKERS B terminals are set in the main zone.
- Select “ZONE B” if the speakers connected to the SPEAKERS B terminals are set in another zone. If SPEAKERS A is turned off and SPEAKERS B is turned on, all the speakers including the subwoofer in the main zone are muted and this unit outputs sound at the SPEAKERS B terminals only.

Notes

- If you connect headphones to the PHONES jack of this unit, the sound is output from both headphones and the SPEAKERS B terminals when “SP B” is set to “ZONE B”.
- If a DSP program is selected when “SP B” is set to “ZONE B”, this unit automatically enters the Virtual CINEMA DSP mode (see page 50).

Zone 2 amplifier ZONE2 AMP

Use this feature to select either the external or the internal amplifier to amplify the Zone 2 speakers.

Choices: **INT**, **EXT**



- Select “INT” (internal amplifier) to use the internal amplifier of this unit if you connected your Zone 2 speakers directly to the PRESENCE/ZONE2 speaker terminals of this unit.
- Select “EXT” (external amplifier) if you do not use the Zone 2 speakers or if you connected your Zone 2 speakers to the external amplifier in Zone 2 connected to the ZONE 2 OUTPUT jacks of this unit.

ADVANCED SETUP

This unit has additional menus that are displayed in the front panel display. The advanced setup menu offers additional operations to adjust and customize the way this unit operates. Change the initial settings (indicated in bold under each parameter) to reflect the needs of your listening environment.

Notes

- The settings you make are reflected next time you press MASTER ON/OFF inward to the ON position to turn on this unit (see page 31).
- Only MASTER ON/OFF, STRAIGHT (EFFECT) and the PROGRAM selector are effective while you are using the advanced setup menu.
- All the other operations cannot be made while you are using the advanced setup menu.
- The advanced setup menu is only available in the front panel display.

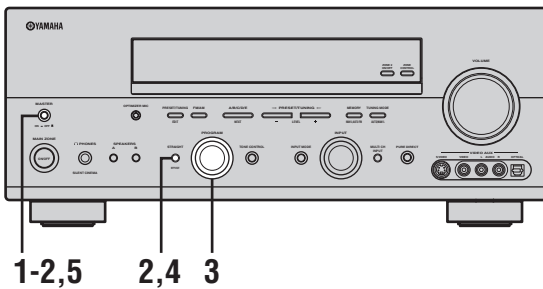

- 1 Press MASTER ON/OFF on the front panel to release it outward to the OFF position to turn off this unit.**



- 2 Press and hold STRAIGHT (EFFECT) on the front panel and then press MASTER ON/OFF inward to the ON position to turn on this unit.** This unit turns on, and the advanced setup menu appears in the front panel display.

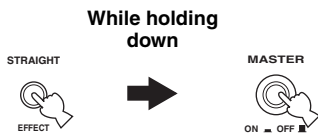

- 3 Rotate the PROGRAM selector on the front panel to select the parameter you want to adjust.**

The name of the selected parameter appears in the front panel display. See page 91 for a complete list of available parameters.

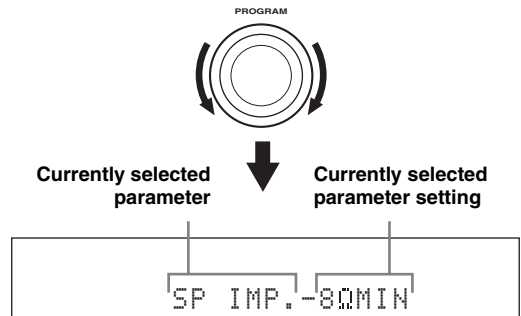

- 4 Press STRAIGHT (EFFECT) on the front panel repeatedly to change the selected parameter setting.**



- 5 Press MASTER ON/OFF on the front panel to release it outward to the OFF position to save the new setting and turn off this unit.**



The settings you made are reflected next time you turn on this unit.

Speaker impedance SP IMP.

Use this feature to set the speaker impedance of this unit so that it matches that of your speakers.

Choices: **8ΩMIN**, **6ΩMIN**

- Select “8ΩMIN” to set the speaker impedance to 8 Ω .
- Select “6ΩMIN” to set the speaker impedance to 6 Ω .

SP IMP.	Speaker	Impedance level
8ΩMIN	Front	If you use one set (A or B), the impedance of each speaker must be 8 Ω or higher.
		If you use two sets (A and B), the impedance of each speaker must be 16 Ω or higher.*
	Center	
	Surround	The impedance of each speaker must be 8 Ω or higher.
	Surround back	
6ΩMIN	Front	If you use one set (A or B), the impedance of each speaker must be 4 Ω or higher.
		If you use two sets (A and B), the impedance of each speaker must be 8 Ω or higher.
	Center	
	Surround	The impedance of each speaker must be 6 Ω or higher.
	Surround back	

* The Canada model cannot use two separate speaker systems (A and B) simultaneously when “SP IMP.” is set to “8ΩMIN”.

Factory presets PRESET

Use this feature to reset all the parameters of this unit to the initial factory settings (see page 103).

Choices: **CANCEL**, **RESET**

- Select “CANCEL” not to reset any parameters of this unit.
- Select “RESET” to reset the parameters of this unit.

Notes

- This setting completely resets all the parameters of this unit including the “SET MENU” parameters. However, the advanced setup menu parameters will not be initialized.
- The initial factory settings are activated next time you turn on this unit.

Remote control AMP ID REMOTE AMP

Use this feature to set the AMP ID of this unit for remote control recognition (see page 95).

Choices: **ID1**, **ID2**

- Select “ID1” when the remote control AMP ID library code is set to “00001”.
- Select “ID2” when the remote control AMP ID library code is set to “00002”.

Note

You need to set the corresponding remote control AMP library code for the remote control (see page 95).

Remote control TUNER ID REMOTE TUN

Use this feature to set the TUNER ID of this unit for remote control recognition (see page 95).

Choices: **ID1**, **ID2**

- Select “ID1” when the remote control TUNER ID library code is set to “81916”.
- Select “ID2” when the remote control TUNER ID library code is set to “81917”.

Note

You need to set the corresponding remote control TUNER library code for the remote control (see page 95).

Tuner frequency step TU
(Asia and General models only)

Use this feature to set the tuner frequency step according to the frequency spacing in your area.

Choices: **AM10/FM100**, **AM9/FM50**

- Select “AM10/FM100” for North, Central and South America.
- Select “AM9/FM50” for all other areas.

REMOTE CONTROL FEATURES

In addition to controlling this unit, the remote control can also operate other audiovisual components made by YAMAHA and other manufacturers. To control your TV or other components, you must set up the appropriate remote control code for each input source (see page 94).

Controlling this unit, a TV, or other components

■ Controlling this unit

Set the component selector switch to AMP to control this unit.

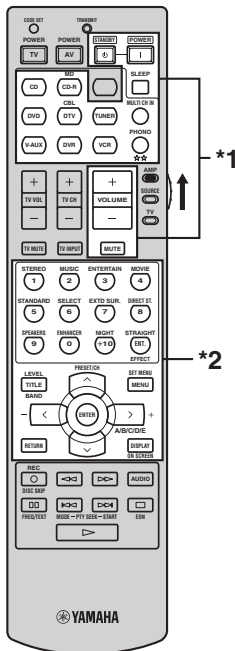

■ Controlling a TV

Set the component selector switch to TV to control your TV. To control your TV, you must set the appropriate remote control code for DTV/CBL or PHONO (see page 94). When you set the remote control codes for both DTV/CBL and PHONO, priority is given to the one set for DTV/CBL.

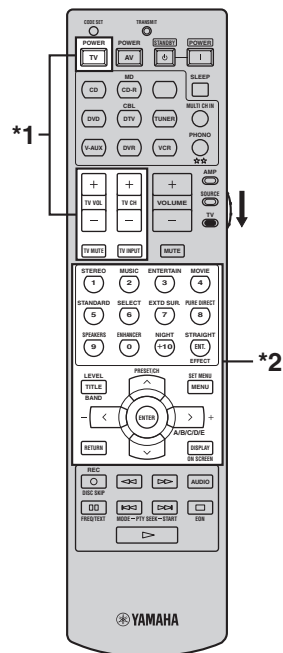

Notes

- *1 These buttons always control this unit regardless of the component selector switch position.
- *2 These buttons control this unit only when the component selector switch is set to AMP.

Notes

- *1 These buttons always control your TV regardless of the component selector switch position.

Remote control	Digital TV/Cable TV
TV POWER	Turns on or off the power.
TV VOL +/-	Increases or decreases the volume level.
TV CH +/-	Changes the channel number.
TV MUTE	Mutes the audio output.
TV INPUT	Changes the input source.

- *2 These buttons control your TV only when the component selector switch is set to TV. For details, see the "Digital TV/ Cable TV" column on page 93.

■ Controlling other components

Set the component selector switch to SOURCE to control other components selected with the input selector buttons or the blank button on the right of MD/CD-R. You must set the appropriate remote control code for each input source (see page 94). The following table shows the function of each control button used to control other components assigned to each input selector button or the blank button on the right of MD/CD-R. Be advised that some buttons may not correctly operate the selected component.

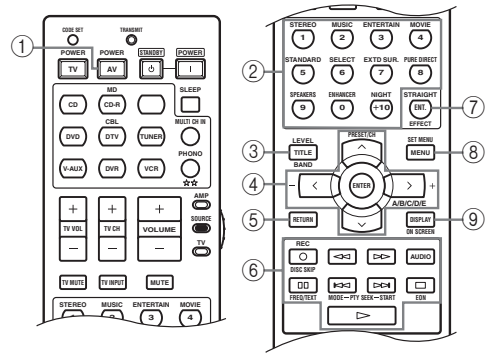

Remote control	DVD player/recorder	VCR	Digital TV/Cable TV	LD player	CD player	MD/CD recorder	Tuner	iPod®
① AV POWER	Power *1	Power *1	Power *2	Power *1	Power *1	Power *1		
② 1-9, 0, +10	Numeric buttons	Numeric buttons	Numeric buttons	Numeric buttons	Numeric buttons	Numeric buttons	Preset stations (1-8)	
③ TITLE	Title						Band	
④ PRESET/CH ^	Up	VCR channel up	Up				Preset up (1-8)	Up
PRESET/CH v	Down	VCR channel down	Down				Preset down (1-8)	Down
A/B/C/D/E <	Left		Left				Preset down (A-E)	
A/B/C/D/E >	Right		Right				Preset up (A-E)	
ENTER	Enter		Enter					Subsequent menu
⑤ RETURN	Return		Return					
⑥ REC/DISC SKIP	Disc skip (player) Rec (recorder) *3	Rec *3	Rec *2*3		Disc skip	Rec *3		
▷	Play	Play	Play *2	Play	Play	Play		Play
◁◁	Search backward	Search backward	Search backward *2	Search backward	Search backward	Search backward		Search backward *4
▷▷	Search forward	Search forward	Search forward *2	Search forward	Search forward	Search forward		Search forward *4
AUDIO	Audio	Audio	Audio *2	Sound				
⏸	Pause	Pause	Pause *2	Pause	Pause	Pause		Pause
◀◁	Skip backward	Skip backward	Skip backward *2	Skip backward	Skip backward	Skip backward		Skip backward
▷▷	Skip forward	Skip forward	Skip forward *2	Skip forward	Skip forward	Skip forward		Skip forward
⏹	Stop	Stop	Stop *2	Stop	Stop	Stop		Stop
⑦ ENT.	Title/Index	Enter	Enter	Chapter/Time	Index	Index		
⑧ MENU	Menu		Menu					Previous menu
⑨ DISPLAY	Display	Display	Display	Display	Display	Display		Display

Notes

*1 This button is operational only when the original remote control supplied with the component has a POWER button.

*2 These buttons control your VCR or DVD recorder only when you set the appropriate remote control code for DVR (see page 94).

*3 When you use this button to record a source, press it twice repeatedly to prevent a malfunction.

*4 Press and hold to search backward or forward.

Setting the remote control code

You can control your TV and other components by setting the appropriate remote control code for each input source. For a complete list of available remote control codes, refer to “LIST OF REMOTE CONTROL CODES” at the end of this manual.

The following table shows the default component in the “Library (component category)” column and the remote control code for each input source.

Remote Control Code Default Settings

Input source	Library (component category)	Manufacturer	Default code
CD	CD	YAMAHA	61907
MD/CD-R	MD	YAMAHA	70888
DVD	DVD	YAMAHA	40539
DTV/CBL	–	–	–
TUNER	TUNER	YAMAHA	81916
V-AUX	–	–	–
DVR	DVR	YAMAHA	51544
VCR	–	–	–
PHONO	–	–	–
Blank button	TAPE	YAMAHA	70524

Note

You may not be able to operate your YAMAHA component even if a YAMAHA remote control code is initially set as listed above. In this case, try setting other YAMAHA remote control codes.



The blank button is the one on the right of MD/CD-R.

- 1 Press one of the input selector buttons to select the component you want to set up.

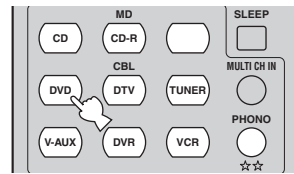

- 2 Press CODE SET using a ballpoint pen or a similar object.

The TRANSMIT indicator on the remote control flashes twice.



- 3 Press the numeric buttons (0 to 9) to enter the five-digit remote control code for the component to be used.

The TRANSMIT indicator on the remote control flashes twice, and the remote control code for the selected component is set.

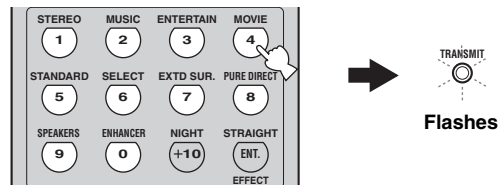

Refer to “LIST OF REMOTE CONTROL CODES” at the end of this manual.

Notes

- If the manufacturer of your component has more than one code, try each of them until you find the correct one.
- If you do not press any buttons within 30 seconds in step 3, the setup process is canceled. If this happens, repeat the setup procedure.
- If you enter the code number “9980”, the remote control code previously set for the selected component is cleared.

Setting library codes

You can operate multiple YAMAHA receivers or amplifiers in the same room with the supplied remote control simultaneously. Set the appropriate library code to select and operate the desired component with the supplied remote control.

Setting remote control AMP ID library codes

Select one of the following codes to set the remote control AMP ID library code for the component you want to use.

1 Press CODE SET using a ballpoint pen or a similar object.

The TRANSMIT indicator on the remote control flashes twice.



Setting remote control TUNER ID library codes

Select one of the following codes to set the remote control TUNER ID library code for the component you want to use.

1 Press TUNER to select "TUNER" as the input source.



2 Press CODE SET using a ballpoint pen or a similar object.

The TRANSMIT indicator on the remote control flashes twice.



2 Press the numeric buttons to enter the code number "00001" or "00002".

The TRANSMIT indicator on the remote control flashes twice, and the AMP ID library code is changed.

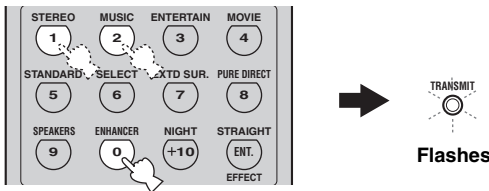

3 Press the numeric buttons to enter the code number "81916" or "81917".

The TRANSMIT indicator on the remote control flashes twice, and the TUNER ID library code is changed.

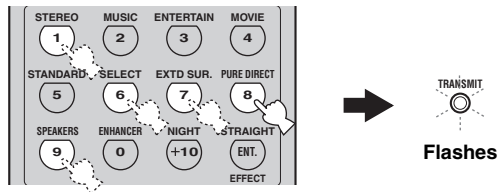

AMP ID library code *1	Function	Remote control AMP ID *2
00001 (initial setting)	To operate this unit using the default code.	ID1 (initial setting)
00002	To operate this unit using an alternative code.	ID2

TUNER ID library code *1	Function	Remote control TUNER ID *2
81916 (initial setting)	To operate this unit using the default code.	ID1 (initial setting)
81917	To operate this unit using an alternative code.	ID2

*1 The remote control setting

*2 The setting of this unit (see page 91)

*1 The remote control setting

*2 The setting of this unit (see page 91)

Notes

- You need to set the corresponding remote control AMP ID of this unit in the advanced setup (see page 91).
- When using multiple YAMAHA receivers/amplifiers, you may be able to operate the other components simultaneously with the default code setting. In this case, set one of the alternative codes to operate this unit separately.

Notes

- You need to set the corresponding remote control TUNER ID of this unit in the advanced setup (see page 91).
- When using multiple YAMAHA receivers/amplifiers, you may be able to operate the other components simultaneously with the default code setting. In this case, set one of the alternative codes to operate this unit separately.

Resetting all remote control codes

Use this feature to clear all the remote control codes previously set and reset all of them to the initial factory settings.

1 Press CODE SET using a ballpoint pen or a similar object.

The TRANSMIT indicator on the remote control flashes twice.



2 Press the numeric buttons to enter the code number "9981".

The TRANSMIT indicator on the remote control flashes twice, and all the remote control codes previously set are cleared and reset to the initial factory settings.

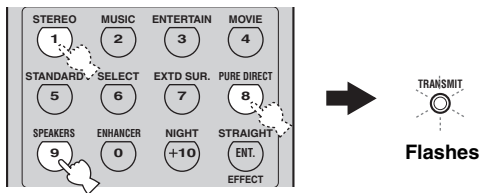

If you do not press any buttons within 30 seconds after step 2, the clearing process is canceled. In this case, repeat the clearing procedure.

USING MULTI-ZONE CONFIGURATION

This unit allows you to configure a multi-zone audio system. The Zone 2 feature allows you to set this unit to reproduce separate input sources in the main zone and the second zone (Zone 2). You can control this unit from the second zone using the supplied remote control.

Only analog signals are sent to the second zone. Any source you want to listen to in the second zone must be connected to the analog AUDIO IN jacks of this unit.

Connecting Zone 2

You need the following additional equipment to use the multi-zone functions of this unit:

- An infrared signal receiver in the second zone.
- An infrared signal emitter in the main zone. This emitter transmits the infrared signals from the remote control via the infrared signal receiver in the second zone to a CD player or a DVD player, etc. in the main zone.
- An amplifier and speakers in the second zone.

- ☀️ Since there are many possible ways to connect and use this unit in a multi-zone configuration, we recommend that you consult with your nearest authorized YAMAHA dealer or service center about the Zone 2 connections that best meet your requirements.
- Some YAMAHA models are able to connect directly to the REMOTE jacks of this unit. If you own these products, you may not need to use an infrared signal emitter. Up to 6 YAMAHA components can be connected as shown below.

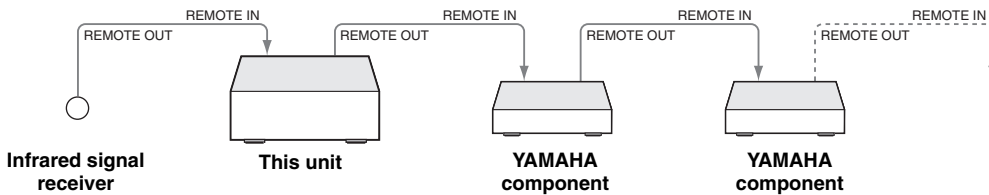

Using the external amplifier

To use the external amplifiers in Zone 2, select “EXT” in “ZONE2 AMP” (see page 89).

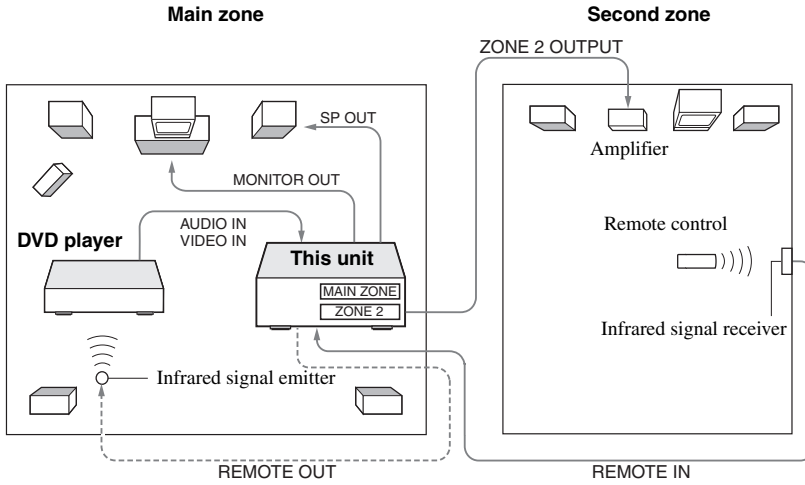

Notes

- When you do not use the main zone, press MAIN ZONE ON/OFF on the front panel to turn off the main zone. Adjust the volume control on the amplifier in the second zone.
- To avoid unexpected noise, DO NOT USE the Zone 2 feature with CDs encoded in DTS.

Using the internal amplifier of this unit

To use the internal amplifiers of this unit, select “INT” in “ZONE2 AMP” (see page 89).

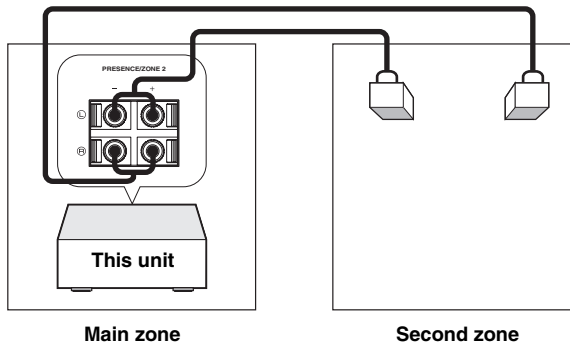

IMPORTANT SAFETY NOTICE

The PRESENCE/ZONE2 speaker terminals of this Receiver should not be connected to a Passive Loudspeaker Selector Box or more than one loudspeaker per channel. Connection to a Passive Loudspeaker Selector Box or multiple speakers per channel could create an abnormally low impedance load resulting in amplifier damage. See this owner’s manual for correct usage. Compliance with minimum speaker impedance information for all channels must be maintained at all times. This information is found on the back panel of your Receiver.

Controlling Zone 2

You can select and control Zone 2 by using the control buttons on the front panel or on the remote control. The available operations are listed as follows:

- Selecting the input source of Zone 2
- Tuning into FM or AM when “TUNER” is selected as the input source of Zone 2 (see page 52)
- Enjoying music stored on your iPod stationed in a YAMAHA iPod universal dock (such as YDS-10 sold separately) connected to the DOCK terminal of this unit when “V-AUX” is selected as the input source (see page 101)
- Adjusting the volume level of the Zone 2 speakers connected directly to the PRESENCE/ZONE2 speaker terminals of this unit when “ZONE2 AMP” in “OPTION MENU” is set to “INT” (see page 89)

Note

You must complete each step while the ZONE2 indicator is flashing in the front panel display. Otherwise, the Zone 2 mode is automatically canceled and this unit returns to the normal operation mode. In this case, repeat the Zone 2 selection procedure.

■ Controlling Zone 2 with the front panel

1 Press ZONE 2 ON/OFF to turn on Zone 2.



ZONE 2 ON/OFF is operational only when MASTER ON/OFF on the front panel is pressed inward to the ON position. Once MASTER ON/OFF on the front panel is pressed inward to the ON position, you can also press POWER or STANDBY on the remote control to turn on the main zone and Zone 2 or set them to the standby mode.

2 Press ZONE CONTROL to control Zone 2.

The ZONE2 indicator flashes in the front panel display for approximately 5 seconds.



3 Rotate the INPUT selector to select the desired input source while the ZONE2 indicator is flashing in the front panel display.

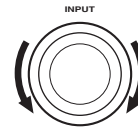

- Select “TUNER” as the input source to use the TUNER features in Zone 2. For details about the TUNER operations, see “FM/AM TUNING” on page 52.
- Select “V-AUX” as the input source to use iPod features in Zone 2. For details about the iPod operations, see “USING iPod®” on page 101.



To adjust the volume level of Zone 2, set “ZONE2 AMP” in “OPTION MENU” to “INT” (see page 89) and then rotate VOLUME.

4 Press ZONE 2 ON/OFF to set Zone 2 to the standby mode.



■ Setting the remote control to the Zone 2 mode

Note

The remote control is originally set to the main mode to control the main zone. To control Zone 2 with the remote control, you must first set the remote control to the Zone 2 mode.

1 Press CODE SET using a ballpoint pen or a similar object.

The TRANSMIT indicator on the remote control flashes twice.



2 Press the numeric buttons to enter the code number "9992".

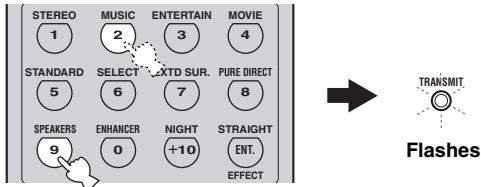

■ Controlling Zone 2 with the remote control

Notes

- The remote control is originally set to the main mode to control the main zone, and the TRANSMIT indicator on the remote control is turned off when the remote control is set to the main mode.
- When the remote control is set to the Zone 2 mode, POWER, STANDBY, VOLUME +/-, MUTE, and the input selector buttons are set to control Zone 2. However, the rest of the remote control buttons remain in the main mode.
- The remote control automatically exits from the Zone 2 mode in the following cases:
 - when you do not make any operations within 10 seconds after the remote control is set to the Zone 2 mode.
 - when you press a remote control button other than POWER, STANDBY, VOLUME +/-, MUTE, and the input selector buttons.

1 Press and hold POWER or STANDBY and then press PHONO to set the remote control to the Zone 2 mode.

- Press POWER when the main zone is turned on.
 - Press STANDBY when the main zone is turned off.
- The TRANSMIT indicator on the remote control lights up while the remote control is set to the Zone 2 mode.

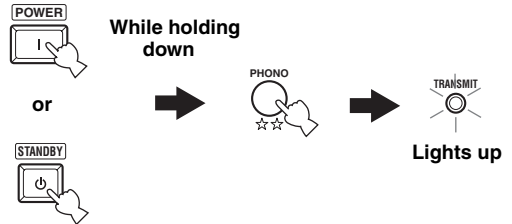

2 Press POWER to turn on Zone 2.



3 Press one of the input selector buttons to select the desired input source of Zone 2.

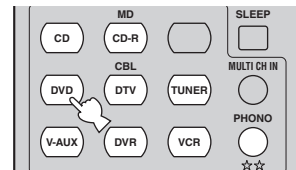

To adjust the volume level of Zone 2, set "ZONE2 AMP" in "OPTION MENU" to "INT" (see page 89) and then rotate VOLUME.

4 Press STANDBY to set Zone 2 to the standby mode.



USING iPod®

Once you have stationed your iPod in a YAMAHA iPod universal dock (such as YDS-10 sold separately) connected to the DOCK terminal of this unit (see page 24), you can enjoy playback of your iPod using the supplied remote control. You can also use the Compressed Music Enhancer mode of this unit to improve the sound quality of the compression artifacts (such as the MP3 format) stored on your iPod (see page 43).

Notes

- Only iPod (Click and Wheel), iPod nano, and iPod mini are supported.
- Compatibility with your iPod may vary depending on the software version of your iPod.
- The controls on your iPod are not operational when you operate your iPod using the OSD of this unit.
- There are some characters that cannot be displayed in the front panel or in the OSD of this unit.
- The name of the song being played appears in the front panel display up to 14 alphanumeric characters.



- For a complete list of the remote control functions used to control your iPod, see the “iPod” column in “Controlling other components” on page 93.
- For a complete list of status messages that appear in the front panel display and in the OSD, see the “iPod” section in “TROUBLESHOOTING” on page 108.

Setting the remote control code

You need to first assign the remote control code to V-AUX on the remote control to control your iPod when “V-AUX” is selected as the input source.

- 1 Press V-AUX on the remote control to select “V-AUX” as the input source.**



- 2 Press CODE SET on the remote control using a ball point pen or a similar object.**

The TRANSMIT indicator on the remote control flashes twice.



Flashes

- 3 Press the numeric buttons to enter the code number “81981”.**

The TRANSMIT indicator on the remote control flashes twice, and the remote control code for V-AUX is set.

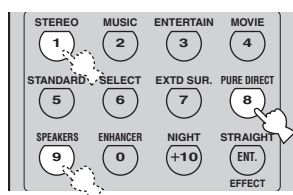

Flashes

Controlling iPod

Once the remote control code is assigned to V-AUX on the remote control, you can control your iPod when “V-AUX” is selected as the input source. The operations of your iPod can be done with or without the aid of the OSD of this unit.

■ Controlling iPod without using the OSD

Once “V-AUX” is selected as the input source, you can perform the basic operations of your iPod (see page 93) using the supplied remote control without the aid of the OSD of this unit.

Note

Operations can be also done with the controls on your iPod.



For a complete list of the remote control buttons used to control your iPod, see the “iPod” column in “Controlling other components” on page 93.

■ Controlling iPod using the OSD

Once “V-AUX” is selected as the input source, you can perform the advanced operations of your iPod using the supplied remote control with the aid of the OSD of this unit. You can also browse the songs stored on your iPod in the OSD. Further, you can change or adjust settings for your iPod to suit your personal preferences.

Notes

- Operations cannot be done with the controls on your iPod.
- The YAMAHA logo appears in the display window of your iPod.
- The “Setup” parameters can be changed or adjusted only in the OSD.
- Press ENTER on the remote control to toggle between the “Setup” parameter settings.
- You cannot browse the photos or video clips stored on your iPod in the OSD. Instead, you must use the controls on your iPod to select the desired photos or video clips. For details, see “Controlling iPod without using the OSD” on page 101.



- Press MENU on the remote control to move back to the previous menu level.
- For a complete list of the remote control buttons used to control your iPod, see the “iPod” column in “Controlling other components” on page 93.
- A character that cannot be recognized by this unit will be replaced with an underscore “_”.

1 Press DISPLAY on the remote control.

The following display appears in the OSD.



2 Press ^/∨ on the remote control to select the desired menu and then press ENTER to enter the selected menu.

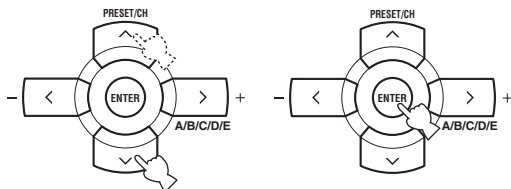

Choices: Playlists (playlists), Artists (artists), Albums (albums), Songs (songs), Genres (genres), Composers (composers), Setup (setup)

- Playlists > Songs
- Artists > Albums > Songs
- Albums > Songs
- Songs
- Genres > Artists > Albums > Songs
- Composers > Albums > Songs
- Setup > Shuffle, Repeat, Onscreen, FL Scroll

Shuffle Shuffle

Use this feature to set this unit to play songs or albums in a random order.

Choices: **Off**, Songs, Albums

- Select “Off” to deactivate this feature.
- Select “Songs” to set this unit to play songs in a random order.
- Select “Albums” to set this unit to play albums in a random order.

Note

When “Shuffle” is set to a setting other than “Off”, the highlighted letter “S” appears in the top right corner while songs or albums are being shuffled.

Repeat Repeat

Use this feature to set this unit to repeat one song or a sequence of songs.

Choices: **Off**, One, All

- Select “Off” to deactivate this feature.
- Select “One” to set this unit to repeat one song.
- Select “All” to set this unit to repeat a sequence of songs.

Note

When “Repeat” is set to a setting other than “Off”, the highlighted letter “R” appears in the top right corner while one song or a sequence of songs are being repeated.

On-screen display time Onscreen

Use this feature to set the amount of time for which the OSD is displayed after you perform a certain operation on your iPod.

Choices: **Always**, 5s, 10s

- Select “Always” to display the OSD unceasingly while you are operating your iPod.
- Select “5s” to turn off the OSD 5 seconds after you perform a certain operation on your iPod.
- Select “10s” to turn off the OSD 10 seconds after you perform a certain operation on your iPod.

Front panel display scroll FL Scroll

Use this feature to set whether to display the iPod operation status in the front panel display in a continuous manner or by 14 alphanumeric characters at once.

Choices: **Cont**, Once

- Select “Cont” to display the iPod operation status in the front panel display in a continuous manner.
- Select “Once” to display the iPod operation status in the front panel display by 14 alphanumeric characters at once.

RESETTING THE SYSTEM

Use this feature to reset all the parameters of this unit to the initial factory settings.

Notes

- This procedure completely resets all the parameters of this unit including the “SET MENU” parameters. However, the advanced setup menu parameters will not be initialized.
- The initial factory settings are activated next time you turn on this unit.

To cancel the initialization procedure at any time without making any changes, press MASTER ON/OFF on the front panel to release it outward to the OFF position.

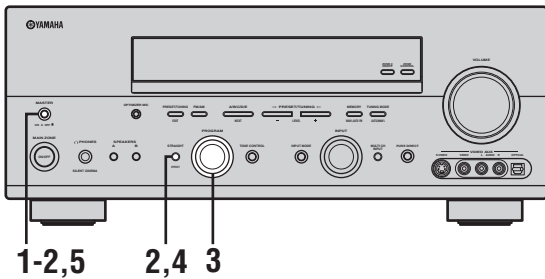

1 Press MASTER ON/OFF on the front panel to release it outward to the OFF position to turn off this unit.



2 Press and hold STRAIGHT (EFFECT) on the front panel and then press MASTER ON/OFF inward to the ON position to turn on this unit. This unit turns on, and the advanced setup menu appears in the front panel display.

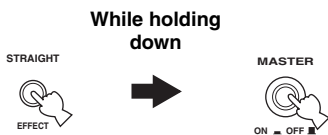

3 Rotate the PROGRAM selector on the front panel to select “PRESET”.



4 Press STRAIGHT (EFFECT) on the front panel repeatedly to select “RESET”.



Select “CANCEL” to cancel the initialization procedure without making any changes.

5 Press MASTER ON/OFF on the front panel to release it outward to the OFF position to confirm your selection and turn off this unit.



TROUBLESHOOTING

Refer to the table below when this unit does not function properly. If the problem you are experiencing is not listed below or if the instruction below does not help, turn off this unit, disconnect the power cable, and contact the nearest authorized YAMAHA dealer or service center.

■ General

Problem	Cause	Remedy	See page
This unit fails to turn on or enters the standby mode soon after the power is turned on.	The power cable is not connected or the plug is not completely inserted.	Connect the power cable firmly.	—
	The speaker impedance setting is incorrect.	Set the speaker impedance to match your speakers.	30
	The protection circuitry has been activated.	Make sure that all speaker wire connections on this unit and on all speakers are secure and that the wire for each connection does not touch anything other than its respective connection.	13
	This unit has been exposed to a strong external electric shock (such as lightning or strong static electricity).	Set this unit to the standby mode, disconnect the power cable, plug it back in after 30 seconds and then use it normally.	—
No sound	Incorrect input or output cable connections.	Connect the cables properly. If the problem persists, the cables may be defective.	19-27
	“INPUT MODE” is set to “DTS” or “ANALOG”.	Set “INPUT MODE” to “AUTO”.	41
	No appropriate input source has been selected.	Select an appropriate input source with the INPUT selector on the front panel (or the input selector buttons on the remote control) and MULTI CH INPUT on the front panel (or MULTI CH IN on the remote control).	38, 44
	Speaker connections are not secure.	Secure the connections.	13
	The front speakers to be used have not been selected properly.	Select the front speakers with SPEAKERS A and/or B on the front panel or SPEAKERS on the remote control.	38
	The volume is turned down.	Turn up the volume.	—
	The sound is muted.	Press MUTE or VOLUME +/- on the remote control to resume audio output and then adjust the volume.	40
	“INPUT MODE” is set to “ANALOG” while playing a source encoded in DTS.	Set “INPUT MODE” to “AUTO” or “DTS”.	41
	Signals this unit cannot reproduce are being input from a source component, such as a CD-ROM.	Play a source whose signals can be reproduced by this unit.	—
No picture	The output and input for the picture are connected to different types of video jacks.	Set “VIDEO CONV.” to “ON”.	87

Problem	Cause	Remedy	See page
The sound suddenly goes off.	The protection circuitry has been activated because of a short circuit, etc.	Check that the speaker impedance setting is correct.	30, 91
		Check that the speaker wires are not touching each other and then turn this unit back on.	—
	The sleep timer has turned off this unit.	Turn on this unit, and play the source again.	—
	The sound is muted.	Press MUTE or VOLUME +/- on the remote control to resume audio output.	40
Sound is heard from the speaker on one side only.	Incorrect cable connections.	Connect the cables properly. If the problem persists, the cables may be defective.	13
	Incorrect settings in “SPEAKER LEVEL”.	Adjust the “SPEAKER LEVEL” settings.	82
Only the center speaker outputs substantial sound.	When playing a monaural source with a CINEMA DSP program, the source signal is directed to the center channel, and the front and surround speakers output effect sounds.		
No sound is heard from the center speaker.	“CENTER SP” in “SET MENU” is set to “NONE”.	Set “CENTER SP” to “SML” or “LRG”.	80
	One of the HiFi DSP programs (except for “7ch Stereo”) has been selected.	Try another sound field program.	63
No sound is heard from the surround speakers.	“SUR. L/R SP” in “SET MENU” is set to “NONE”.	Set “SUR. L/R SP” to “SML” or “LRG”.	80
	This unit is in the “STRAIGHT” mode and a monaural source is being played back.	Press STRAIGHT (EFFECT) on the front panel so that “STRAIGHT” disappears from the front panel display.	45
No sound is heard from the surround back speakers.	“SUR. L/R SP” in “SET MENU” is set to “NONE” and “SUR. B L/R SP” is automatically set to “NONE”.	Set “SUR. L/R SP” and “SUR. B L/R SP” to a setting other than “NONE”.	80
	“SUR. B L/R SP” in “SET MENU” is set to “NONE”.	Set “SUR. B L/R SP” to a setting other than “NONE”.	80
No sound is heard from the subwoofer.	“LFE/BASS OUT” in “SET MENU” is set to “FRNT” when a Dolby Digital or DTS signal is being played.	Set “LFE/BASS OUT” to “SWFR” or “BOTH”.	81
	“LFE/BASS OUT” in “SET MENU” is set to “SWFR” or “FRNT” when a 2-channel source is being played.	Set “LFE/BASS OUT” to “BOTH”.	81
	The source does not contain low-frequency signals.		

Problem	Cause	Remedy	See page
Dolby Digital or DTS sources cannot be played. (Dolby Digital or DTS indicator in the front panel display does not light up.)	The connected component is not set to output Dolby Digital or DTS digital signals.	Make an appropriate setting following the operating instructions for your component.	—
	“INPUT MODE” is set to “ANALOG”.	Set “INPUT MODE” to “AUTO” or “DTS”.	41
A humming sound is heard.	Incorrect cable connections.	Connect the audio cables firmly. If the problem persists, the cables may be defective.	—
The volume level is low while a record is being played.	The record is being played on a turntable with an MC cartridge.	Connect your turntable to this unit through an MC-head amplifier.	23
The volume level cannot be increased, or the sound is distorted.	The component connected to the AUDIO OUT (REC) jacks of this unit is turned off.	Turn on the power of the component.	—
The sound effect cannot be recorded.	It is not possible to record the sound effect with a recording component.		
A source cannot be recorded by a digital recording component connected to the DIGITAL OUTPUT jack.	The source component is not connected to the DIGITAL INPUT jacks of this unit.	Connect the source component to the DIGITAL INPUT jacks.	20, 23
	Some components cannot record the Dolby Digital or DTS sources.		
A source cannot be recorded by an analog component connected to the AUDIO OUT (REC) jacks.	The source component is not connected to the analog AUDIO IN jacks of this unit.	Connect the source component to the analog AUDIO IN jacks.	23
The sound field parameters and some other settings of this unit cannot be changed.	“MEMORY GUARD” in “SET MENU” is set to “ON”.	Set “MEMORY GUARD” to “OFF”.	88
This unit does not operate properly.	The internal microcomputer has been frozen by an external electric shock (such as lightning or excessive static electricity) or by a power supply with low voltage.	Disconnect the power cable from the AC wall outlet and then plug it in again after about 30 seconds.	—
“CHECK SP WIRES” appears in the front panel display.	Speaker cables are short-circuited.	Make sure all speaker cables are connected correctly.	13
There is noise interference from digital or radio frequency equipment.	This unit is too close to the digital or high-frequency equipment.	Move this unit further away from such equipment.	—
The picture is disturbed.	The video source uses scrambled or encoded signals to prevent dubbing.		
This unit suddenly enters the standby mode.	The internal temperature becomes too high and the overheat protection circuitry has been activated.	Wait about 1 hour for this unit to cool down and then turn it back on.	—

■ Tuner

	Problem	Cause	Remedy	See page
FM	FM stereo reception is noisy.	The characteristics of FM stereo broadcasts may cause this problem when the transmitter is too far away or the antenna input is poor.	Check the antenna connections.	28
			Try using a high-quality directional FM antenna.	—
			Use the manual tuning method.	53
	There is distortion, and clear reception cannot be obtained even with a good FM antenna.	There is multi-path interference.	Adjust the antenna position to eliminate multi-path interference.	—
	The desired station cannot be tuned into with the automatic tuning method.	The signal is too weak.	Use a high-quality directional FM antenna.	—
			Use the manual tuning method.	53
	Previously preset stations can no longer be tuned into.	This unit has been disconnected for a long period.	Set preset stations.	54, 55
AM	The desired station cannot be tuned into with the automatic tuning method.	The signal is weak or the antenna connections are loose.	Tighten the AM loop antenna connections and orient it for the best reception.	—
			Use the manual tuning method.	53
	There are continuous crackling and hissing noises.	Noises result from lightning, fluorescent lamps, motors, thermostats and other electrical equipment.	Use an outdoor antenna and a ground wire. This will help somewhat, but it is difficult to eliminate all noise.	—
	There are buzzing and whining noises.	A TV set is being used nearby.	Move this unit away from the TV set.	—

■ Remote control

Problem	Cause	Remedy	See page	
The remote control does not work nor function properly.	Wrong distance or angle.	The remote control functions within a maximum range of 6 m and no more than 30 degrees off-axis from the front panel.	8	
	Direct sunlight or lighting (from an inverter type of fluorescent lamp, etc.) is striking the remote control sensor of this unit.	Reposition this unit.	—	
	The batteries are weak.	Replace all batteries.	3	
	The remote control code is not correctly set.	Set the remote control code correctly using “LIST OF REMOTE CONTROL CODES” at the end of this manual.		94
		Try setting another code for the same manufacturer using “LIST OF REMOTE CONTROL CODES” at the end of this manual.		94
	The library code of the remote control and the remote control ID of this unit do not match.	Match the remote control ID of this unit with the corresponding remote control library code.		91, 95
Even if the remote control code is correctly set, there are some models that do not respond to the remote control.				

■ iPod

Note

In case of a transmission error without a status message appearing in the front panel and in the OSD, check the connection to your iPod (see page 24).

Status message	Cause	Remedy	See page
Loading...	This unit is in the middle of recognizing the connection with your iPod.		
	This unit is in the middle of acquiring song lists from your iPod.		
Connect error	There is a problem with the signal path from your iPod to this unit.	Turn off this unit and reconnect the YAMAHA iPod universal dock to the DOCK terminal of this unit.	24
		Try resetting your iPod.	—
Unknown type	The iPod being used is not supported by this unit.	Only iPod (Click and Wheel), iPod nano, and iPod mini are supported.	—
iPod connected	Your iPod is properly stationed in a YAMAHA iPod universal dock (such as YDS-10 sold separately) connected to the DOCK terminal of this unit, and the connection between your iPod and this unit is complete.		
Disconnected	Your iPod was removed from a YAMAHA iPod universal dock (such as YDS-10 sold separately) connected to the DOCK terminal of this unit.	Station your iPod back in a YAMAHA iPod universal dock (such as YDS-10 sold separately) connected to the DOCK terminal of this unit.	24
Unable to play	This unit cannot play back the songs currently stored on your iPod.	Check that the songs currently stored on your iPod are playable.	—
		Store some other playable music files on your iPod.	—

■ AUTO SETUP

Before AUTO SETUP

Error message	Cause	Remedy	See page
Connect MIC!	Optimizer microphone is not connected.	Connect the supplied optimizer microphone to the OPTIMIZER MIC jack on the front panel.	32
Unplug HP!	Headphones are connected.	Unplug the headphones.	—

During AUTO SETUP

Error message	Cause	Remedy	See page
E-1:NO FRONT SP	Front L/R channel signals are not detected.	Select the front speakers with SPEAKERS A or B.	38
		Check the front L/R speaker connections.	13
E-2:NO SURR.SP	A surround channel signal is not detected.	Check the surround speaker connections.	13
E-3:NO PRNS SP	A presence channel signal is not detected.	Check the presence speaker connections.	13
E-4:SBR->SBL	Only right surround back channel signal is detected.	Connect the surround back speaker to the LEFT SURROUND BACK SPEAKERS terminal if you only have one surround back speaker.	13
E-5:NOISY	Background noise is too loud.	Try running "AUTO SETUP" in a quiet environment.	—
		Turn off noisy electric equipment like air conditioners or move them away from the optimizer microphone.	—
E-6:CHECK SUR.	Surround back speakers are connected, though surround L/R speakers are not.	Connect surround speakers when you use surround back speakers.	13
E-7:NO MIC	The optimizer microphone was unplugged during the "AUTO SETUP" procedure.	Connect the supplied optimizer microphone to OPTIMIZER MIC jack on the front panel.	32
E-8:NO SIGNAL	The optimizer microphone does not detect test tones.	Check the microphone setting.	32
		Check the speaker connections and placement.	13
E-9:USER CANCEL	The "AUTO SETUP" procedure was cancelled due to user activity.	Run "AUTO SETUP" again.	32
E-10:INTERNAL ERROR	An internal error occurred.	Run "AUTO SETUP" again.	32

After AUTO SETUP

Warning message	Cause	Remedy	See page
W-1: OUT OF PHASE	Speaker polarity is not correct. This message may appear depending on the speakers even when the speakers are connected correctly.	Check the speaker connections for proper polarity (+ or -).	13
W-2: OVER 24m (80ft)	The distance between the speaker and the listening position is over 24 m.	Bring the speaker closer to the listening position.	—
W-3: LEVEL ERROR	The difference of volume level among speakers is excessive. (No level correction is made.)	Readjust the speaker installation so that all speakers are set in locations with similar conditions.	—
		Check the speaker connections.	13
		Use speakers of similar quality.	—
		Adjust the output volume of the subwoofer.	33

Notes

- If the “ERROR” or “WARNING” screens appears, check the cause of the problem, then run “AUTO SETUP” again.
- If warning “W-1” appears, corrections are made, but they may not be optimal.
- If warning “W-2” or “W-3” appears, no corrections are made.
- If error “E-10” occurs repeatedly, please contact a qualified YAMAHA service center.

GLOSSARY

Audio information

■ Dolby Digital

Dolby Digital is a digital surround sound system that gives you completely independent multi-channel audio. With 3 front channels (front L/R and center), and 2 surround stereo channels, Dolby Digital provides 5 full-range audio channels. With an additional channel especially for bass effects, called LFE (Low Frequency Effect), the system has a total of 5.1-channels (LFE is counted as 0.1 channel). By using 2-channel stereo for the surround speakers, more accurate moving sound effects and surround sound environment are possible than with Dolby Surround. The wide dynamic range from maximum to minimum volume reproduced by the 5 full-range channels and the precise sound orientation generated using digital sound processing provide listeners with unprecedented excitement and realism. With this unit, any sound environment from monaural up to a 5.1-channel configuration can be freely selected for your enjoyment.

■ Dolby Digital EX

Dolby Digital EX creates 6 full-bandwidth output channels from 5.1-channel sources. This is done using a matrix decoder that derives 3 surround channels from the 2 in the original recording. For the best results, Dolby Digital EX should be used with movie sound tracks recorded with Dolby Digital Surround EX. With this additional channel, you can experience more dynamic and realistic moving sound especially with scenes with “fly-over” and “fly-around” effects.

■ Dolby Pro Logic II

Dolby Pro Logic II is an improved technique used to decode vast numbers of existing Dolby Surround sources. This new technology enables a discrete 5-channel playback with 2 front left and right channels, 1 center channel, and 2 surround left and right channels instead of only 1 surround channel for conventional Pro Logic technology. There are three modes available: “Music mode” for music sources, “Movie mode” for movie sources and “Game mode” for game sources.

■ Dolby Pro Logic IIx

Dolby Pro Logic IIx is a new technology enabling discrete multi-channel playback from 2-channel or multi-channel sources. There are three modes available: “Music mode” for music sources, “Movie mode” for movie sources (for 2-channel sources only) and “Game mode” for game sources.

■ Dolby Surround

Dolby Surround uses a 4-channel analog recording system to reproduce realistic and dynamic sound effects: 2 front left and right channels (stereo), a center channel for dialog (monaural), and a surround channel for special sound effects (monaural). The surround channel reproduces sound within a narrow frequency range. Dolby Surround is widely used with nearly all video tapes and laser discs, and in many TV and cable broadcasts as well. The Dolby Pro Logic decoder built into this unit employs a digital signal processing system that automatically stabilizes the volume on each channel to enhance moving sound effects and directionality.

■ DTS 96/24

DTS 96/24 offers an unprecedented level of audio quality for multi-channel sound on DVD video, and is fully backward-compatible with all DTS decoders. “96” refers to a 96 kHz sampling rate compared to the typical 48 kHz sampling rate. “24” refers to 24-bit word length. DTS 96/24 offers sound quality transparent to the original 96/24 master, and 96/24 5.1-channel sound with full-quality full-motion video for music programs and motion picture soundtracks on DVD video.

■ DTS (Digital Theater Systems) Digital Surround

DTS digital surround was developed to replace the analog soundtracks of movies with a 6.1-channel digital sound track, and is now rapidly gaining popularity in movie theaters around the world. Digital Theater Systems Inc. has developed a home theater system so that you can enjoy the depth of sound and natural spatial representation of DTS digital surround in your home. This system produces practically distortion-free 6.1-channel sound (technically, front left and right, center, surround left and right, and LFE 0.1 (subwoofer) channels for a total of 5.1 channels). This unit incorporates a DTS-ES decoder that enables 6.1-channel reproduction by adding the surround back channel to the existing 5.1-channel format.

■ ITU-R

ITU-R is the radio communication sector of the ITU (International Telecommunication Union). ITU-R recommends a standard speaker placement which is used in many critical listening rooms, especially for mastering purposes.

■ LFE 0.1 channel

This channel reproduces low-frequency signals. The frequency range of this channel is from 20 Hz to 120 Hz. This channel is counted as 0.1 because it only enforces a low-frequency range compared to the full-range reproduced by the other 5/6 channels in Dolby Digital or DTS 5.1/6.1-channel systems.

■ Neo:6

Neo:6 decodes the conventional 2-channel sources for 6-channel playback by the specific decoder. It enables playback with the full-range channels with higher separation just like digital discrete signal playback. There are two modes available: "Music mode" for music sources and "Cinema mode" for movie sources.

■ PCM (Linear PCM)

Linear PCM is a signal format under which an analog audio signal is digitized, recorded and transmitted without using any compression. This is used as a method of recording CDs and DVD audio. The PCM system uses a technique for sampling the size of the analog signal per very small unit of time. Standing for "Pulse Code Modulation", the analog signal is encoded as pulses and then modulated for recording.

■ Sampling frequency and number of quantized bits

When digitizing an analog audio signal, the number of times the signal is sampled per second is called the sampling frequency, while the degree of fineness when converting the sound level into a numeric value is called the number of quantized bits. The range of rates that can be played back is determined based on the sampling rate, while the dynamic range representing the sound level difference is determined by the number of quantized bits. In principle, the higher the sampling frequency, the wider the range of frequencies that can be played back, and the higher the number of quantized bits, the more finely the sound level can be reproduced.

Video information

■ Component video signal

With the component video signal system, the video signal is separated into the Y signal for the luminance and the P_B and P_R signals for the chrominance. Color can be reproduced more faithfully with this system because each of these signals is independent. The component signal is also called the "color difference signal" because the luminance signal is subtracted from the color signal. A monitor with component input jacks is required in order to output component signals.

■ Composite video signal

With the composite video signal system, the video signal is composed of three basic elements of a video picture: color, brightness and synchronization data. A composite video jack on a video component transmits these three elements combined.

■ S-video signal

With the S-video signal system, the video signal normally transmitted using a pin cable is separated and transmitted as the Y signal for the luminance and the C signal for the chrominance through the S-video cable. Using the S VIDEO jack eliminates video signal transmission loss and allows recording and playback of even more beautiful images.

Sound field program information

■ **CINEMA DSP**

Since the Dolby Surround and DTS systems were originally designed for use in movie theaters, their effect is best felt in a theater having many speakers designed for acoustic effects. Since home conditions, such as room size, wall material, number of speakers, and so on, can differ so widely, it is inevitable that there are differences in the sound heard. Based on a wealth of actually measured data, YAMAHA CINEMA DSP uses YAMAHA original sound field technology to combine Dolby Pro Logic, Dolby Digital and DTS systems to provide the audiovisual experience of movie theater in the listening room of your own home.

■ **SILENT CINEMA**

YAMAHA has developed a natural, realistic sound effect DSP algorithm for headphones. Parameters for headphones have been set for each sound field so that accurate representations of all the sound field programs can be enjoyed on headphones.

■ **Virtual CINEMA DSP**

YAMAHA has developed a Virtual CINEMA DSP algorithm that allows you to enjoy DSP sound field surround effects even without any surround speakers by using virtual surround speakers. It is even possible to enjoy Virtual CINEMA DSP using a minimal two-speaker system that does not include a center speaker.

SPECIFICATIONS

AUDIO SECTION

- Minimum RMS Output Power for Front, Center, Surround, Surround back
20 Hz to 20 kHz, 0.06% THD, 8 Ω 100 W
- Maximum Power (EIAJ)
[Asia, China, Korea and General models]
1 kHz, 10% THD, 8 Ω 140 W
- Dynamic Power (IHF)
8/6/4/2 Ω 135/170/200/245 W
- Maximum Output Power [Europe and Asia models]
1 kHz, 0.7% THD, 4 Ω 150 W
- IEC Output Power [Europe and Asia models]
1 kHz, 0.06% THD, 8 Ω 110 W
- Damping Factor (IHF)
20 Hz to 20 kHz, 8 Ω 120 or more
- Frequency Response
CD terminal to Front L/R 10 Hz to 100 kHz, -3 dB
- Total Harmonic Distortion
PHONO to REC OUT (20 Hz to 20 kHz, 1 V) 0.02% or less
CD, etc. to Front L/R
(20 Hz to 20 kHz, 50 W, 8 Ω) 0.06% or less
- Signal to Noise Ratio (IHF-A Network)
Phono (5 mV) to REC OUT
[Europe, Australia, Asia and Korea models] 81 dB or more
[Other models] 86 dB or more
CD (250 mV) to Front L/R, Effect Off 100 dB or more
- Residual Noise (IHF-A Network)
Front L/R 150 μ V or less
- Channel Separation (1 kHz/10 kHz)
PHONO (shorted) to Front L/R 60 dB/55 dB or more
CD (5.1 k Ω terminated) to Front L/R 60 dB/45 dB or more
- Tone Control (Front L/R)
BASS Boost/Cut \pm 6 dB/50 Hz
BASS Turnover Frequency 350 Hz
TREBLE Boost/Cut \pm 6 dB/20 kHz
TREBLE Turnover Frequency 3.5 kHz
- Phones Output 150 mV/100 Ω
- Input Sensitivity/Input Impedance
PHONO 3.5 mV/47 k Ω
CD, etc. 200 mV/47 k Ω
MULTI CH INPUT 200 mV/47 k Ω
- Output Level/Output Impedance
REC OUT 200 mV/1.2 k Ω
PRE OUT 2 V/1.2 k Ω
SUBWOOFER 4 V/1.7 k Ω
ZONE 2 OUTPUT 200 mV/1.2 k Ω

VIDEO SECTION

- Video Signal Type PAL/NTSC
- Signal to Noise Ratio 50 dB or more
- Frequency Response (MONITOR OUT)
Component 5 Hz to 60 MHz, -3 dB

FM SECTION (except for U.K. model)

- Tuning Range
[U.S.A. and Canada models] 87.5 to 107.9 MHz
[Asia and General models] 87.5/87.50 to 108.0/108.00 MHz
[Other models] 87.50 to 108.00 MHz
- Usable Sensitivity (IHF) 1.0 μ V (11.2 dBf)
- Signal to Noise Ratio (IHF)
Mono/Stereo 76 dB/70 dB
- Harmonic Distortion (1 kHz)
Mono/Stereo 0.2%/0.3%
- Stereo Separation (1 kHz) 42 dB
- Frequency Response 20 Hz to 15 kHz, +0.5, -2 dB

AM SECTION (except for U.K. model)

- Tuning Range
[U.S.A. and Canada models] 530 to 1710 kHz
[Asia and General models] 530/531 to 1710/1611 kHz
[Other models] 531 to 1611 kHz
- Usable Sensitivity 300 μ V/m

GENERAL

- Power Supply
[U.S.A. and Canada models] AC 120 V, 60 Hz
[Australia model] AC 240 V, 50 Hz
[China model] AC 220 V, 50 Hz
[Korea model] AC 220 V, 60 Hz
[Europe model] AC 230 V, 50 Hz
[General model] AC 110/120/220/230-240 V, 50/60 Hz
[Asia model] AC 220/230-240 V, 50/60 Hz
- Power Consumption
[U.S.A. and Canada models] 400 W/500 VA
[Other models] 440 W
- Standby Power Consumption 0.1 W or less
- AC Outlets
[Australia model] 1 (Total 100 W maximum)
[U.S.A., Canada and China models]... 2 (Total 100 W maximum)
[Europe, Asia and General models]..... 2 (Total 50 W maximum)
- Dimensions (W x H x D) 435 x 171 x 421 mm
(17.1 x 6.7 x 16.6 in)
- Weight 12.3 kg (27.1 lbs)

**LIST OF REMOTE CONTROL CODES
LISTE DES CODES DE COMMANDE
LISTE DER FERNBEDIENUNGSCODES
LISTA ÖVER FJÄRRSTYRNINGSKODER
LIJST MET AFSTANDBEDIENINGSCODES
СПИСОК КОДОВ ДИСТАНЦИОННОГО УПРАВЛЕНИЯ**

CABLE TV RECEIVER

ABC 10003
ADB 11230, 11269
AICHI DENSHI 11512
AMSTRAD 11222
AUNA 11230, 11269
AUSTAR 10276
BIRMINGHAM
CABLE COMMUNICATIONS
10276
BRITISH TELECOM
10003
CABLE & WIRELESS
11068
DX ANTENNA
11500, 11502
FASTWEB 11630
FRANCE TELECOM
10817, 11734
FREEBOX 11482
FUJITSU 11497
GENERAL INSTRUMENT
10003, 10276
GOLDEN CHANNEL
11110
HOMECHOICE 11590
JERROLD 10003, 10276
MACAB 10817
MADRITEL 11230
MASPRO 11510
MOTOROLA 10276, 11106,
11483
MR ZAP 11112
MR. ZAP 11112
NEC 11496
NOKIA 11569
NOOS 10817, 11624
NTL 10003, 11060,
11068
ONO 11068
OPTUS 10276
PACE 11060, 11068,
11577
PANASONIC 10375, 11488
PHILIPS 10817
PIONEER 11021, 11500
PVP STEREO
VISUAL MATRIX
10003
SAGEM 10817, 11112,
11624
SAMSUNG 11060, 11666
SATBOX 10375
SCIENTIFIC ATLANTA
11510
SONY 11460
STARCOM 10003
SUMITOMO 11500, 11503,
11504
SUPERCABLE
10276
TELE DANMARK
11016

TELEWEST 11068
THOMSON 11110, 11734
TORX 10003
TOSHIBA 11509
TRI-VISION 11257
UNITED CABLE
10003
UPC 11582
US ELECTRONICS
10276

**CABLE/PVR
COMBINATION**

FRANCE TELECOM 11734
FREEBOX 11482
MOTOROLA 11106
NOKIA 11569
NOOS 11624
SUPERCABLE 10276
THOMSON 11734
UPC 11582

**DBS/PVR
COMBINATION**

@SAT 11300
ATSAT 11300
BRITISH SKY BROADCASTING
11175
CANALSATELLITE
11339
COMAG 11412
DIGIFUSION 11645
DIRECTV 10099, 10639
DREAM MULTIMEDIA
11237
ECHOSTAR 10610
FORCE 11194
FOXTEL 11356
GBSAT 11214
HUMAX 11176, 11427,
11670, 11675
KATHREIN 11221, 11561
MAXIMUM 11334
NOKIA 11310, 11311
OPENTEL 11412
PACE 11423, 11623
PANASONIC 11320
PHILIPS 10099
REBOX 11214
SAGEM 11253, 11307,
11692
SHARP 11489
SIEMENS 11657
SKY 11175, 11848,
11850
SKYPLUS 11412
SONY 10639
STRONG 11300
THOMSON 11534, 11900
TOPFIELD 11206, 11545
TPS 11253, 11307
ZEHNDER 11075, 11412

SATELLITE RECEIVER

@SAT 11300
@SKY 11334
ABSAT 10713
ADB 10642, 11259,
11367, 11473,
11491
AIWA 11514, 11515
AKAI 10200
ALBA 10713, 11284
ALLSAT 10200, 11017,
11043
ALLSONIC 10369
ALLTECH 10713
ALLVISION 11232, 11334,
11412
AMITRONICA 10713
AMPERE 10132
AMSTRAD 10132, 10713,
10847, 10885,
11113, 11175
ANGLO 10713
ANKARO 10369, 10713,
11279
ANTSAT 11017, 11083
ARCON 11043, 11075,
11279
ARNION 11300
ASAT 10200
ASCI 10114, 11334,
11461
ASLF 10713
ASSCOM 10853
ASTON 11129
ASTRA 10713
ASTRO 10133, 10173,
10369, 10658,
11099, 11100,
11113
ATSAT 11300
ATSKY 11334
AUDIOLINE 11429
AURORA 10879
AUSTAR 10642, 10879,
11259
AXIS 10369, 11111
B@YTRONIC 11412
BENTLEY WALKER
11017
BEST 10369
BIG SAT 11457
BLACK DIAMOND
11284
BLAUPUNKT 10173
BLUE SKY 10713
BOCA 10132, 10713,
11232, 11366,
11474
BOSTON 11251
BRAINWAVE 10658
BRITISH SKY BROADCASTING
10847, 11175
BROCO 10713

BSKYB 10847, 11175
BT 11296
BUBU SAT 10713
BUSH 11284, 11471,
11672
CANAL DIGITAL
10853, 11622
CANAL+ 10853
CANALSATELLITE
10853, 11339,
11853
CENTREX 11457
CGV 11413
CHESS 10114, 10713,
11334
CITYCOM 10299, 10818,
11075, 11176,
11232
COLOMBIA 10132
COLUMBIA 10132
COMAG 10132, 11232,
11366, 11412,
11413, 11579
CONDOR 10369
CONRAD 10132, 10369
COSHIP 11457
CYRUS 10200
D-BOX 10873
DAEWOO 10713, 11111,
11296, 11743
DELTASAT 11075
DGTEC 11242
DIGENIUS 10299, 11161
DIGIALITY 11685
DIGIFUSION 11645
DIGIQUEST 11457, 11473
DIGISAT 11232
DIGISKY 11457
DIGITALL WORLD
11227
DIJAM 11296
DIRECTV 10099, 10639
DISTRATEL 10885, 11283,
11704
DMT 11075
DNT 10200
DREAM MULTIMEDIA
11237
DUNE 10369
DX ANTENNA 11530
ECHOSTAR 10167, 10610,
10713, 10853,
11200, 11323,
11409, 11467,
11473, 11477
EINHELL 10132, 10713
ELAP 10587, 10713,
11129, 11567
ELSAT 10713
ELTA 10200, 10369
EMME ESSE 10369
EMTECH 11214
ENGEL 10713, 11017,
11251

EURIEULT	10885	JAEGER	11334	MICRO	10713	PMB	10713
EUROLINE	11251	JVC	11507, 11531, 11532	MICRO ELEKTRONIC	10299, 10369	PREISNER	10132, 10262, 11113, 11366
EUROPHON	10132, 10299	K-SAT	10713	MICROMAXX	11075	PREMIER	10292
EUROSKY	10114, 10132, 10262, 10299, 10369	KAMM	10713	MICROSTAR	10713	PREMIERE	10292, 10873, 11429
EUROSTAR	10818, 10898	KAON	11300	MICROTEC	10132, 10200, 10713, 11232, 11412	PRIMACOM	11111
EUTELSAT	10713	KATELCO	11111	MORGAN'S	10642, 10879	QUADRAL	10369
FENNER	10369, 10713	KATHREIN	10114, 10173, 10200, 10249, 10442, 10480, 10504, 10553, 10622, 10658, 10713, 10818, 10898, 11221, 11416, 11561, 11567	MULTICHOICE	10200	QUELLE	10299
FERGUSON	10711, 11291			MYRYAD	10713	RADIOLA	10200
FINLUX	10573			MYSAT	11270, 11519	RADIX	11113
FLAIR MATE	10713			NEC	11334	RCA	11291
FMD	11457			NEOTION	11322	REBOX	11214
FORCE	11194			NETGEM	10099	RED STAR	10369
FORTEC STAR	11017, 11083			NETSAT	11322	REGAL	11251
FOXTEL	10879, 11356			NEUF TELECOM	11322	RFT	10200, 10541
FRACARRO	10125	KENNEX	10125	NEUF TV	11322	ROADSTAR	10713, 10853
FTEMAXIMAL	10369, 10713, 11556	KENWOOD	10853	NEUHAUS	10713	ROVER	10369, 10713
FUBA	10173, 10262, 10299, 10369, 10573, 11161, 11214	KEY WEST	10132	NEULING	10132, 11232	S-ZWO	11207
FUGIONKYO	10125	KITON	10114	NEUSAT	10587, 10713, 11279	SAB	11251
GALAXIS	10369, 10853, 11111, 11557	KOSCOM	11043	NEVELING	11161	SABA	10885
GARDINER	10818	KOSMOS	10442	NEXTWAVE	11017	SAGEM	10820, 11114, 11253, 11307, 11690, 11691, 11692, 11694
GARNET	11075	KREILING	10114, 10249, 10658, 11461	NIKKO	10200, 10713	SAMSUNG	10853, 11017, 11206, 11243, 11293, 11458, 11570
GBSAT	11214	KREISELMEYER	10173	NOKIA	10573, 10751, 10853, 10873, 11023, 11223, 11310, 11311, 11723	SANYO	11219
GECCO	11157, 11273, 11412	L&S ELECTRONIC	10132, 10369, 11043, 11334	NORDMENDE	11611	SAT CONTROL	11300
GENERAL SATELLITE	11176	LABGEAR	11296	OKANO	10442	SAT TEAM	10713
GF	11043	LASAT	10132, 10173, 10299, 10369	OPENTELE	11232, 11412	SATEC	10713
GF STAR	11043	LEMON	11461	OPTELEX	10114, 10713, 11043, 11283	SATELCO	10369, 11232
GLOBO	11251, 11626	LENCO	10369, 10713	OPTUS	10879	SATPLUS	11100
GOD DIGITAL	10200	LENOXX	11611	ORBIS	11232, 11334, 11412	SATSTATION	11083
GOLD BOX	10292, 10853	LG	11075, 11226	ORBITECH	10114, 10541, 11099, 11100	SCHAUB LORENZ	11214
GOLDEN INTERSTAR	11283	LIFESAT	10132, 10299, 10369, 10713, 11043	P/SAT	11232	SCHNEIDER	11206, 11251
GOLDVISION	11017	LIFETEC	10587	PACE	10200, 10329, 10720, 10847, 10853, 10867, 11175, 11323, 11423, 11623, 11850	SCHWAIGER	10132, 10504, 10587, 10885, 11075, 11083, 11111, 11334, 11412, 11457, 11474
GOODMANS	11246, 11284	LODOS	11284	PACIFIC	11284	SCS	10299
GRUNDIG	10173, 10847, 10853, 10879, 11291	LOGIX	11017, 11075	PACKARD BELL	11111	SEDEA ELECTRONIQUE	10125, 10132, 11206, 11283
HAENSEL & GRETEL	10132	LORENZEN	10132, 10299, 10867, 11161, 11579	PALCOM	10299, 10587, 11161, 11409	SEG	10114, 10369, 11075, 11251, 11626
HANDAN	11622	LUPUS	10369	PANASAT	10879	SEPTIMO	10885
HANSEATIC	11099, 11100	LUXOR	10573	PANASONIC	10847, 11104, 11304, 11320, 11404, 11508, 11526, 11527, 11528	SERINO	10610
HAUPPAUGE	11672	LUXORIT	11681	PANDA	10173	SERVISAT	10713, 11251
HB	11214	M VISION	11557	PANSAT	11011	SHARP	10541, 11489, 11513, 11517
HDT	11011	MANATA	10132, 10713	PATRIOT	10132	SIEMENS	10173, 11657
HE@D	11279	MANHATTAN	11017, 11083	PHILIPS	10099, 10133, 10173, 10200, 10292, 10818, 10853, 10898, 11114, 11118, 11672	SILVA	10299
HIRSCHMANN	10125, 10173, 10299, 10369, 10573, 11111, 11232, 11412	MARANTZ	10200	PHONOTREND	11017, 11200	SKANTIN	10713
HITACHI	11250, 11284, 11518, 11523, 11525	MASPRO	10173, 10713, 11520, 11530	PILOTIME	11339	SKARDIN	10587
HUMAX	11176, 11225, 11427, 11648, 11670, 11675, 11743	MATSUI	10173, 11284	PINO	11334	SKR	10713
HUTH	10132, 11017, 11075	MAXIMUM	11075, 11334, 11685	PIONEER	10292, 10329, 10352, 10853, 11308	SKT	11449
HYUNDAI	11011, 11075	MDS	11225	PLASMATIC	10442	SKY	10099, 10847, 11175, 11848, 11849, 11850
ICAN	11367	MEDIACOM	11206			SKY ITALIA	11848, 11849
ID DIGITAL	11176	MEDIASAT	10292, 10853			SKY XL	11251, 11412
ILLUSION SAT	11557	MEDION	10132, 10299, 10369, 10713, 11043, 11075, 11232, 11334, 11412, 11626			SKY+	11175
IMPERIAL	11429	MEGASON	10713			SKYMASTER	10587, 10713, 11075, 11200, 11409, 11611
INGELEN	10114	MEGA	10200			SKYMAX	10200
INTERNATIONAL	10132	MELELECTRONIC	10818			SKYPLUS	11232, 11334, 11412
INTERSTAR	11017, 11214	METRONIC	10132, 10713, 10818, 10885, 11279, 11283, 11334, 11691, 11704				
		METZ	10173				

SKYSAT	10114, 10713	TOPFIELD	11206, 11207, 11208, 11545, 11722	MIND	11272	ANSONIC	20009, 20292, 20370, 20668
SKYVISION	11334			NIVEUS MEDIA			
SL	10132, 10299				11272	APEX DIGITAL	20890, 21217
SM ELECTRONIC		TOSHIBA	11501, 11516, 11530	NORTHGATE	11272	ARDEM	20037, 20714
	10587, 10713, 11200, 11409			PACKARD BELL		ARISTONA	20037, 20556
SMART	10132, 10299, 10713, 11113, 11157, 11232, 11273, 11413	TPS	10820, 11253, 11307		11272	ART	21037
		TRIAD	10372	PINNACLE SYSTEMS		ASORA	20009
SONY	10282, 10292, 10639, 10847, 10853, 11524, 11558	TRIAx	10114, 10132, 10200, 10713, 10853, 11099, 11113, 11157, 11227, 11251, 11291, 11296	PIONEER	11447	ASUKA	20218, 20264
SR	10132			RICAVISION	11010	AUDIOSONIC	20009, 20037, 20109, 20218, 20264, 20370, 20374, 20486, 20714, 20715
STARLITE	10200	TT-MICRO	11429	SYSTEMAX	11272	AUDIOTON	20264, 20486
STREAM	11848	URNSAT	10713	TOSHIBA	11272	AUDIOWORLD	20698
STRONG	10125, 10132, 10369, 10713, 10820, 10853, 10879, 11146, 11157, 11258, 11300, 11409, 11430, 11626	TWINNER	10713	TOUCH	11272	AWA	20009, 20108, 20606
		UEC	10879	VIEWSONIC	11272	AXXENT	20009
SUNNY	11300	UNIDEN	11521	VOODOO	11272	BAIRD	20208
SUNNY SOUND		UNISAT	10132, 10200	ZT GROUP	11272	BANG & OLUFSEN	
	10369	UNITED	11251				20565
SUNSAT	10713	UNIVERSUM	10114, 10173, 10299, 11099, 11251	TV		BASIC LINE	20009, 20037, 20218, 20374, 20455, 20556, 20668, 21037, 21163
SUNSTAR	10132, 10369, 10642	VAN HUNEN	11161	A.R. SYSTEMS	20374, 20455		
SYSTEC	11334	VARIOSAT	10173	ACER	21339	BAUER	20805
TARBS	11225	VEGA	10369	ACURA	20009	BAUR	20037, 20361, 20512
TBOSTON	11457	VENTANA	10200	ADL	21217	BEAUMARK	20178
TEAC	11225, 11227, 11251, 11322	VESTEL	10114, 11251, 10125, 11279, 11283	ADMIRAL	20093, 20163, 20264	BEKO	20037, 20370, 20418, 20486, 20606, 20714, 20715, 20808, 21037
TECHNISAT	10114, 10200, 10262, 10541, 11099, 11100, 11322	VISIONIC	10114, 10713, 11129, 11457	ADVENT	20817	BELSON	20698
		VISIOSAT	10114, 10713, 11129, 11457	AGB	20516	BEON	20037, 20418
TECHNOMATE		VTECH	10818	AIKO	20009, 20264	BERTHEN	20668
	11283, 11610	WISI	10173, 10299, 10372, 10406, 10638	AIM	20805	BESTAR	20037, 20370, 20374
TECHNOSONIC	11672	WISPLUS	11258	AIWA	21180	BESTAR-DAEWOO	
		WORLDSAT	10114, 11214, 11251, 11323	AKAI	20009, 20035, 20037, 20163, 20178, 20208, 20218, 20264, 20361, 20371, 20433, 20473, 20480, 20516, 20548, 20556, 20602, 20606, 20631, 20696, 20714, 20715, 20729, 20745, 20753, 21207		20374
TECHNOTREND	11429	XRYPTON	10369	AKIBA	20037, 20218, 20455	BLACK DIAMOND	20614, 20821, 21037, 21909
TECHNOWELT	10132	XSAT	10713, 10847, 11214, 11323				
TECHSAN	11017	XTREME	11300	AKITO	20037	BLAUPUNKT	20170, 20195, 20200, 20327, 20455
TECHWOOD	10114, 11284	YAKUMO	11413	AKURA	20009, 20037, 20218, 20264, 20412, 20668, 20714, 21037, 21982	BLUE SKY	20037, 20218, 20455, 20487, 20556, 20668, 20714, 20715, 20808, 21037, 21191
TEKCOMM	11017	ZEHNDER	10114, 10369, 10504, 10818, 11075, 11232, 11251, 11334, 11412, 11413			BOOTS	20009
TELE SYSTEM ELECTRONIC	11611			ALBA	20009, 20037, 20163, 20218, 20355, 20371, 20418, 20443, 20487, 20668, 20714, 21037	BOXLIGHT	20736
TELECIEL	11043	HDTV DECORDER				BPL	20037, 20896
TELEKA	10262	PIONEER	11010	ALL-TEL	20865	BRANDT	20109, 20335, 20560, 20625, 20714
TELESTAR	10114, 11099, 11100, 11251, 11334	SHARP	11010	ALLSTAR	20037	BRINKMANN	20037, 20418, 20486, 20668
				AMPLIVISION	20370		
TELESYSTEM	11251, 11409	OTHER VIDEO ACCESSORIES		AMSTRAD	20009, 20037, 20218, 20264, 20371, 20412, 20433, 20516, 21037	BTC	20218
TELETECH	10114	ABS	11272			BUSH	20009, 20037, 20208, 20218, 20264, 20355, 20361, 20371, 20374, 20487, 20556, 20614, 20617, 20660, 20668, 20698, 20714, 20778, 21037, 21243
TELEVES	10132, 11214, 11300	ALIENWARE	11272	ANAM	20009, 20250	BYDESIGN	21309, 21311
TELEWIRE	11232	CYBERPOWER	11272	ANAM NATIONAL2	0250		
TEVEBOX	11681	GATEWAY	11272				
TEVION	10713, 11409, 11622	HAUPPAUGE	11408	ANDERSSON	21149, 21163		
		HEWLETT PACKARD	11272	ANGLO	20009, 20264		
THOMSON	10292, 10711, 10713, 10820, 10847, 10853, 11046, 11175, 11291, 11498, 11534, 11900	HOWARD COMPUTERS	11272	ANITECH	20009, 20037		
TINY	11672	HP	11272				
TIOKO	10132	HUSH	11272				
TOKAI	10200	IBUYPOWER	11272				
TONNA	10587, 10713, 11611	LINKSYS	11272				
		MEDIA CENTER PC	11272				
		MICROSOFT	11272				

CANTON	20218	DICK SMITH ELECTRONICS	FIRSTLINE	20009, 20037, 20208, 20361, 20374, 20411, 20556, 20668, 20714, 20808, 21037, 21191, 21307, 21363, 21388	GRANADA	20037, 20108, 20163, 20208, 20226, 20473, 20516, 20548, 20560	
CARAD	20610, 20668, 21037	DIGATRON	20037				
CARENA	20037, 20455	DIGILINE	20105, 20668				
CARVER	20054, 20170	DIGITAL LIFE	20780, 20872, 20891				
CASCADE	20009, 20037	DIGITOR	20037, 20698		GRANDIN	20009, 20037, 20163, 20374, 20455, 20610, 20668, 20714, 20715, 20865, 20880, 21037, 21191, 21374, 21388	
CASIO	20037	DIGIX	20880	FISHER	20208, 20370, 20555		
CATHAY	20037	DIXI	20009, 20037				
CCE	20037	DL	20891	FLINT	20037, 20218, 20264, 20455, 20610		
CELEBRITY	20000	DMTECH	21338				
CELESTIAL	20820, 20821	DOMEOS	20668	FORCE	21149	GRUNDIG	20037, 20195, 20443, 20487, 20556, 20587, 20740, 21223
CENTREX	20780	DOMLAND	20394	FORMENTI	20037		
CENTRUM	21037	DREAM VISION	21704	FORTRESS	20093		
CENTURION	20037	DSE	20698	FRABA	20037, 20370		
CGE	20074, 20370, 20418	DUAL	20037, 20352, 20394	FRAC	20009, 20037, 20370, 20610	H&B	20808
CHANGHONG	20821	DVX	20891	FRONTECH	20009, 20163, 20264	HAIER	20698, 20891
CIMLINE	20009, 20218	DYNATRON	20037			HALLMARK	20178
CITIZEN	20060	E-ELITE	20218	FUJIMARO	20865	HANIMEX	20218
CITY	20009	ECCO	20773	FUJITSU	20009, 20683, 20853	HANSEATIC	20009, 20037, 20361, 20377, 20394, 20556, 20634, 20714, 20808
CLARIVOX	20037	EDISON-MINERVA	20487	FUJITSU GENERAL	20009, 20683	HANTAREX	20009, 20037, 20516, 20829, 20865, 21338
CLATRONIC	20009, 20037, 20218, 20264, 20370, 20371, 20606, 20714	EIKI	20735			HANTOR	20037
CLAYTON	21037	ELBE	20292, 20411, 20435, 20516, 20610	FUJITSU SIEMENS	21298	HARMAN/KARDON	20054
CONDOR	20009, 20037, 20264, 20370, 20411, 20418	ELBE-SHARP	20516	FUNAI	20264, 20668	HARSPER	20865
CONIA	20754	ELECTROBAND	20000	GALAXI	20037	HARWA	20773, 21196, 21269
CONRAC	20808	ELECTROGRAPH	21755	GALAXIS	20037, 20370	HARWOOD	20009, 20037, 20412, 20487
CONTEC	20009, 20037	ELEKTA	20264	GATEWAY	21755, 21756	HAVERMY	20093
CONTINENTAL EDISON	20109, 20487	ELIN	20009, 20037, 20361, 20548	GBC	20009, 20218, 20374	HCM	20009, 20037, 20218, 20264, 20412, 20418
COSMEL	20037	ELITE	20218	GE	20093, 20178, 20560, 20625, 20735	HELIOS	20865
CROSLEY	20054, 20074	ELTA	20009, 20264	GEC	20037, 20163, 20361, 20516	HEMA	20009
CROWN	20009, 20037, 20053, 20208, 20370, 20412, 20418, 20486, 20487, 20606, 20712, 20714, 20715, 21037	EMERSON	20037, 20178, 20361, 20370, 20371, 20486, 20714, 21909	GELOSO	20009, 20374	HIKONA	20218
CS ELECTRONICS	20218	ENVISION	21365	GENERAL TECHNIC	20009	HINARI	20009, 20037, 20218, 20264, 20355
CURTIS MATHES	20054, 20060, 20093, 20145	ERRER	20037	GENESIS	20009	HISAWA	20218, 20455, 20610, 20714
CYBERTRON	20218	ESC	20037	GENEXXA	20009, 20163, 20218	HISENSE	20508, 20556, 20780, 21363
CYTRONIX	21298	ETRON	20001, 20009	GERICOM	20808, 20865, 20880, 21206, 21217, 21298	HITACHI	20037, 20105, 20108, 20109, 20145, 20163, 20178, 20225, 20473, 20480, 20481, 20492, 20516, 20548, 20578, 20634, 20744, 20797, 21037, 21149, 21194, 21576
D-VISION	20556	EUROFEEL	20264	GOLDFUNK	20668	HITACHI FUJIAN	20108
DAEWOO	20009, 20037, 20218, 20374, 20556, 20634, 20865, 20880, 21307, 21909	EUROMAN	20037, 20264	GOLDSTAR	20001, 20037, 20109, 20163, 20178, 20361, 20377, 20606, 20714, 20715	HITSU	20009, 20218, 20455, 20610
DAINICHI	20218	EUROPHON	20516	GOODING	20487	HOEHER	20714, 20865
DANSAI	20009, 20035, 20037, 20208	EVOLUTION	21756	GOODMANS	20009, 20035, 20037, 20218, 20264, 20335, 20360, 20371, 20374, 20480, 20487, 20516, 20556, 20560, 20634, 20668, 20714, 20808, 20880, 21037, 21163, 21909	HOME ELECTRONICS	20606
DANSETTE	20412	EXQUISIT	20037			HORNYPHON	20037
DANTAX	20714, 20715	FENNER	20009, 20374			HUANYU	20374
DAVIS	20736	FERGUSON	20037, 20053, 20109, 20195, 20335, 20443, 20548, 20560, 20625, 21037			HUGOSON	20890, 21217
DAYTEK	21207	FIDELITY	20037, 20163, 20264, 20361, 20371, 20412, 20512			HUMAX	21295
DAYTON	20009, 21207	FINLANDIA	20163, 20208, 20346, 20548			HYPER	20009
DAYTRON	20374	FINLUX	20037, 20105, 20346, 20411, 20473, 20480, 20492, 20516, 20631, 20714, 20715, 20808	GORENJE	20370		
DE GRAAF	20208, 20548			GPM	20218		
DECCA	20037, 20516			GRADIENTE	20053, 20170		
DENKO	20264			GRAETZ	20163, 20361, 20371, 20487, 20714		
DENON	20145, 20511						
DENVER	20037, 20587, 21189						
DESMET	20009, 20037						
DIAMANT	20037						
DIAMOND	20825						

HYPSON	20037, 20264, 20455, 20668, 20714, 20715, 21037	KENNEDY	20435	MARANTZ	20037, 20054, 20412, 20556, 20704	NATIONAL	20226
		KENNEX	21037			NEC	20009, 20053, 20156, 20170, 20374, 20455, 20587, 20704, 21704
HYUNDAI	20860, 20865, 20876, 21152, 21244, 21294	KIOTA	20001	MARK	20037, 20714, 20715	NECKERMANN	20037, 20200, 20327, 20370, 20411, 20418, 20556
		KITON	20037, 20668			NEI	20037, 20371
IBERIA	20037	KNEISSEL	20037, 20292, 20374, 20411, 20435, 20556, 20610	MASUDA	20009, 20218	NEOVIA	20865, 20876, 21206, 21318, 21338, 21371, 21373, 21376, 21390
ICE	20218, 20264, 20371	KONKA	20037, 20218, 20371, 20418, 20587, 20641, 20714, 20754	MATSUI	20009, 20035, 20037, 20195, 20208, 20335, 20355, 20371, 20433, 20443, 20455, 20487, 20516, 20556, 20714, 21037	NETSAT	20037
ICES	20218			MATSUSHITA	20250, 20650	NETTV	21755
IYAMA	20877, 21217	KONTAKT	20487	MAXENT	21755	NEUFUNK	20037, 20218, 20556, 20610, 20714
IMPERIAL	20037, 20074, 20370, 20418	KORPEL	20037	MEDIATOR	20037	NIKKAI	20009, 20035, 20037, 20218, 20264
INDIANA	20037	KOYODA	20009	MEDION	20037, 20512, 20556, 20668, 20698, 20714, 20808, 20880, 21037, 21248	NIKKO	20178
INFINITY	20054	KREISEN	20876			NOKIA	20163, 20208, 20346, 20361, 20374, 20473, 20480, 20548, 20606, 20610, 20631
INFOCUS	20736, 20752, 21164, 21206	KYOSHU	20412, 20418	MEGAS	20610		
INGELEN	20163, 20487, 20610, 20714	KYOTO	20163	MEGATRON	20145, 20178		
		L&S ELECTRONIC	20714, 20808	MEI	21037		
INGERSOLL	20009	LASAT	20486	MELELECTRONIC	20009, 20037, 20105, 20163, 20195, 20346, 20374, 20411, 20480, 20492, 20512, 20634, 20714		
INNO HIT	20009, 20516, 21163	LEADER	20009	MEMOREX	20009, 20060, 20178, 20250, 21037		
INNOWERT	20865, 21298	LECSON	20037	MERCURY	20009		
INTERBUY	20037, 20264	LEMAIR	20411	METRONIC	20625		
INTERFUNK	20037, 20163, 20200, 20327, 20361, 20512	LENCO	20037, 20374	METZ	20037, 20367, 20388, 20447, 20587, 20668, 20746, 21163		
		LEYCO	20037, 20264				
INTERNAL	20037, 21909	LG	20037, 20178, 20442, 20556, 20698, 20714, 20715, 20829, 21146, 21148, 21191	MGA	20178		
INTERVISION	20009, 20037, 20218, 20264, 20377, 20394, 20455, 20486, 20487	LIESENK & TTER	20037	MICROMAXX	20037, 20668, 20808, 21037		
		LIESENKOTTER	20037, 20327	MICROSTAR	20808		
IRRADIO	20218, 20371			MIKOMI	21149		
ISUKAI	20037, 20218, 20455	LIFETEC	20037, 20218, 20374, 20668, 20714, 21037	MINATO	20037		
ITS	20264, 20371			MINERVA	20108, 20487, 20516		
ITT	20163, 20208, 20346, 20361, 20473, 20480, 20548, 20610	LOCAL INDIA TV	20264, 20371, 20602	MINOKA	20412		
				MITSUBISHI	20037, 20093, 20108, 20178, 20250, 20512, 20556, 21037		
ITT NOKIA	20163, 20208, 20346, 20361, 20473, 20480, 20548, 20606, 20610	LODOS	21037	MIVAR	20292, 20516, 20609		
		LOEWE	20037, 20136, 20292, 20512, 20516, 20633, 20790	MONACO	20009		
ITV	20037, 20264, 20374	LOGIK	20001, 20773, 20880, 21217	MORGAN'S	20037		
				MOTOROLA	20093		
IX	20877	LOGIX	20668	MTC	20060, 20370, 20512		
JBL	20054	LUKER	21982	MTLOGIC	20714		
JCB	20000	LUMA	21037	MULTITEC	20037, 20486, 20668, 21037		
JDV	21982	LUX MAY	20009, 20037	MULTITECH	20009, 20037, 20264, 20486		
JENSEN	20817	LUXOR	20163, 20208, 20361, 20473, 20480, 20548, 20631, 21037, 21163	MURPHY	20163		
JMB	20443, 20556, 20634			MUSIKLAND	20218		
				MYRYAD	20556		
JOCEL	20712			NAD	20156, 20178, 20361		
JUBILEE	20556			NAIKO	20037, 20606, 21982		
JVC	20053, 20093, 20218, 20371, 20418, 20606, 20650, 20653, 20683, 20731	LXI	20054, 20156, 20178	NAT	20226		
		M ELECTRONIC	20009, 20037, 20105, 20109, 20163, 20346, 20374, 20480				
KAISUI	20009, 20037, 20218, 20455						
		MADISON	20037				
KAPSCH	20163, 20361	MAGNADYNE	20516				
KARCHER	20264, 20606, 20610, 20714, 20778	MAGNAFON	20516				
		MAGNAVOX	20054, 20780				
KATHREIN	20556	MAGNUM	20037, 20714, 20715				
KAWA	20371						
KB ARISTOCRAT	20163	MANESTH	20035, 20037, 20264				
KENDO	20037, 20411, 20610	MANHATTAN	20037, 20668, 20778, 21037				

PALSONIC	20001, 20037, 20264, 20418, 20698, 20773	RADIOLA	20037, 20556	SCHNEIDER	20037, 20163, 20218, 20352, 20361, 20371, 20394, 20556, 20668, 20714, 21037	SOUND & VISION	20374
PANAMA	20037, 20264	RADIOMARELLI	20037, 20516			SOUNDESIGN	20178
PANASHIBA	20001	RADIOSHACK	20037, 20178			SOUNDWAVE	20037, 20418, 20715
PANASONIC	20037, 20163, 20226, 20250, 20361, 20367, 20516, 20548, 20650, 20853, 21210, 21310	RADIOTONE	20009, 20037, 20264, 20412, 20668, 21037	SCOTCH	20178	SPECTRA	20009
PANAVISION	20037, 20411	RCA	20093, 20625, 20679	SCOTLAND	20163	SSANGYONG	20009
PATHE CINEMA		REALISTIC	20178	SCOTT	20178	STANDARD	20009, 20037, 20218, 20374, 21037
	20163	REDIFFUSION	20346, 20361, 20548	SEARS	20054, 20156, 20178	STARLITE	20009, 20037, 20264
PAUSA	20009	REFLEX	20037, 20668, 21037	SEAWAY	20634	STENWAY	20218
PENNEY	20060, 20156, 20178	RELISYS	20865, 20876, 20877, 20878, 21206, 21207, 21268, 21298	SEELVER	21037	STERN	20163, 20411
PERDIO	20037, 20163	REOC	20714	SEG	20009, 20037, 20218, 20264, 20487, 20634, 20668, 21037, 21163	STEVisION	21982
PHILCO	20037, 20054, 20074, 20145, 20370, 20418	REVOX	20037	SEI	20516	STRATO	20009, 20037, 20264
PHILIPS	20009, 20037, 20054, 20200, 20361, 20374, 20556, 20772, 21756	REX	20163, 20264, 20411	SEI-SINUDYNE		STRONG	21149, 21163
PHOENIX	20037, 20486	RFT	20037, 20264	SELECO	20037, 20516, 20163, 20264, 20346, 20371, 20411, 20435	SUNKAI	20355, 20455, 20487, 20610, 20865
PHONOLA	20037	RINEX	20773	SEMP	20156	SUNSTAR	20009, 20037, 20264, 20371
PIONEER	20037, 20109, 20163, 20361, 20486, 20512, 20679, 20760	ROADSTAR	20009, 20037, 20218, 20264, 20418, 20668, 20714, 21037, 21189	SENCORA	20009	SUNWOOD	20037
PIONIER	20486	ROVER	20877	SENTRA	20035	SUPERLA	20516
PLANTRON	20009	ROWA	20698, 20712	SERINO	20093, 20455, 20610	SUPERSCAN	20093
PLAYSONIC	20037, 20714, 20715	ROYAL LUX	20335, 20412	SHARP	20053, 20093, 20200, 20491, 20516, 21163, 21193	SUPERSONIC	21189
POLAROID	20865	SABA	20109, 20163, 20250, 20335, 20361, 20498, 20516, 20548, 20560, 20625, 20714	SHENG CHIA	20093	SUPERTECH	20009, 20037, 20218
PORTLAND	20374	SAGEM	20455, 20610, 20830, 21313	SHINTOSHI	20037	SUPRA	20009
POWERPOINT	20037, 20487, 20698	SAISHO	20009, 20264, 20516	SHIVAKI	20037, 20443	SUPREME	20000
PRANDONI-PRINCE	20361, 20516	SAIVOD	20037, 20668, 20712, 21037, 21163, 21982	SIAREM	20516	SUSUMU	20218, 20335
PRIMA	20264, 20412	SAKAI	20163	SIEMENS	20037, 20195, 20200, 20327	SVA	20587, 20865, 20872
PRINSTON	21037	SALORA	20163, 20208, 20361, 20480, 20516, 20548, 20631	SIERA	20556	SYLVANIA	20054
PRINZ	20361	SALSA	20335	SIESTA	20370	SYSLINE	20037
PROFEX	20009, 20163, 20361	SAMBERS	20516	SILVA	20037, 20361	T+A	20447
PROFI	20009	SAMPO	21755	SILVA SCHNEIDER	20037	TANDBERG	20367
PROFITRONIC	20037	SAMSUNG	20009, 20037, 20060, 20163, 20178, 20208, 20264, 20370, 20482, 20556, 20587, 20618, 20644	SILVER	20361, 20715	TANDY	20093, 20163, 20218
PROLINE	20037, 20411, 20625, 20634, 21037	SANSUI	20037, 20727, 20729, 20861	SILVERCREST	21037	TARGA	21307
PROSONIC	20037, 20668, 20714	SANTON	20009	SINGER	20009, 20335, 20433, 20435	TASHIKO	20163
PROTECH	20009, 20037, 20264, 20418, 20486, 20668, 21037	SANYO	20088, 20108, 20170, 20208, 20370, 20555, 20704, 20735	SINOTEC	20773	TATUNG	20037, 20516, 21756
PROTON	20178	SBR	20037, 20556	SINUDYNE	20516	TCM	20714, 20808
PROVISION	20037, 20556, 20714	SCEPTRE	21217	SKY	20037, 20880	TEAC	20009, 20037, 20170, 20178, 20264, 20412, 20418, 20455, 20512, 20668, 20712, 21037, 21149, 21755, 21909
PROXIMA	20735	SCHAUB LORENZ	20361, 20374, 20486, 20548, 20606, 20714, 21191	SLIDING	20865, 20880, 21318, 21374, 21388	TEC	20009, 20037
PYE	20037, 20374, 20556			SLX	20668	TECH LINE	20037, 20668
QUADRAL	20218			SMARAGD	20487	TECHNICS	20250, 20556, 20650
QUASAR	20009, 20250, 20650, 20865			SOEMTRON	20865, 21298	TECHNISAT	20556
QUELLE	20037, 20074, 20200, 20327, 20361, 20512, 20668, 21037			SOLAVOX	20037, 20163, 20361, 20548	TECHNISSON	20714
R-LINE	20037			SONAWA	20218	TECHNOSONIC	20556
RADIALVA	20218			SONIKO	20037	TECHWOOD	21163
				SONITRON	20208, 20370	TECNIMAGEN	20556
				SONOKO	20009, 20037	TEDELEX	20009, 20891
				SONOLOR	20163, 20208, 20361, 20548	TEKNIKA	20054, 20060
				SONTEC	20009, 20037, 20370	TELECOR	20394
				SONY	20000, 20037, 20053, 20093, 20145, 20156, 20170, 20250, 20353, 21100, 21505, 21751	TELEFUNKEN	20037, 20074, 20109, 20335, 20346, 20486, 20498, 20560, 20625, 20714, 20896
						TELEFUSION	20037
						TELEGAZI	20037
						TELEMAGIC	20735

TELESONIC	20037	UNIVERSUM	20009, 20037,	ZANUSSI	20264	ASA	30037, 30081
TELESTAR	20037, 20556		20074, 20105,	ZENITH	20178, 21909	ASHA	30240
TELESYSTEM	20876		20170, 20200,			ASUKA	30037, 30038
TELETECH	20009, 20037,		20264, 20327,	PVR		AUDIOSONIC	30278
	20668, 21037		20346, 20361,	ABS	31972	AUDIOVOX	30037, 30278
TELEVIEW	20037		20370, 20411,	ALIENWARE	31972	AVP	30000, 30352
TEMPEST	20009		20418, 20473,	CYBERPOWER		AWA	30043
TENNESSEE	20037		20480, 20492,		31972	BAIRD	30000, 30041,
TENSAI	20009, 20037,		20512, 20618,	DELL	31972		30104, 30106
	20105, 20218,		20631, 20668,	GATEWAY	31972	BASIC LINE	30072, 30104,
	20371, 20374,		21037, 21163	HEWLETT PACKARD			30278
	20377, 20715,	UNIVOX	20037, 20163		31972	BEAUMARK	30240
	21037	V2MAX	20865	HOWARD COMPUTERS		BEKO	30104
TENSON	20009	V7 VIDEOSEVEN			31972	BELL & HOWELL	
TEVION	20556, 20668,		21376, 21755	HP	31972		30104
	20714, 20808,	V7VIDEOSEVEN		HUSH	31972	BESTAR	30278
	21037, 21248,		20880	IBUYPOWER	31972	BLACK DIAMOND	
	21298	VESTEL	20037, 20556,	JVC	31279		30642
TEXTET	20009, 20218,		20668, 21037,	LINKSYS	31972	BLACK PANTHER	
	20374		21163	MEDIA CENTER PC			30278
THOMSON	20037, 20109,	VICTOR	20053, 20653		31972	BLAUPUNKT	30034, 30081,
	20335, 20560,	VIDEOCON	20508	MICROSOFT	31972		30162, 30226
	20625	VIDEOLÓGIC	20218	MIND	31972	BLUE SKY	30037, 30072,
THORN	20035, 20037,	VIDEOLÓGIQUE		NIVEUS MEDIA	31972		30278, 30348,
	20074, 20109,		20218	NORTHGATE	31972		30352, 30480,
	20335, 20361,	VIDIKRON	20054, 20735	PANASONIC	31244, 31807,	BONDSTEC	30072
	20512	VIDTECH	20178		31808, 31809	BRANDT	30041, 30206,
TINY	21269	VIEWPIA	20876	PHILIPS	31340		30320, 30321
TINY DIGITAL	20660	VIEWSONIC	20797, 21755	SONY	31636, 31972	BRANDT ELECTRONIQUE	
TMK	20178	VIORE	21207	STACK 9	31972		30041
TOKAI	20009, 20037,	VISION	20037	SYSTEMAX	31972	BRINKMANN	30348
	20163, 20374,	VIZIO	21756	TAGAR SYSTEMS		BROKSONIC	30348
	20668, 21037	VOXSON	20163, 20178,		31972	BUSH	30000, 30072,
TOKAIDO	21037		20418	TOSHIBA	30828, 31008,		30081, 30278,
TOKYO	20035	WALTHAM	20037, 20109,		31972		30315, 30348,
TOMASHI	20218		20163, 20418,	TOUCH	31972		30352, 30642
TONGTEL	20780		20443, 20668,	VIEWSONIC	31972	CALIX	30037
TOSHIBA	20035, 20060,	WARDS	20000, 20054,	VOODOO	31972	CARREFOUR	30045
	20109, 20156,		20060, 20156,	ZT GROUP	31972	CARVER	30081
	20195, 20241,		20178			CASIO	30000
	20508, 20618,	WATSON	20009, 20037,	VCR		CATHAY	30278
	20650, 20714,		20218, 20394,	ABS	31972	CCE	30072, 30278
	20736, 21163,		20668, 21037	ACCENT	30072	CGE	30000
	21164, 21704	WAYCON	20156	ADMIRAL	30048	CIMLINE	30072
TRANS CONTINENS		WEGA	20037	ADVENTURA	30000	CITIZEN	30037, 30278
	20037, 20668,	WELLTECH	20714	ADYSON	30072	CLATRONIC	30000, 30072
	21037	WESTINGHOUSE		AIKO	30278	COLT	30072
TRANS-CONTINENTS			20890	AIWA	30000, 30032,	COMBITECH	30352
	20865, 21374	WHARFEDALE			30037, 30307,	CONDOR	30278
TRANSONIC	20009, 20037,		20037, 20556	AKAI	30041, 30106,	CRAIG	30037, 30072,
	20587, 20698,	WHITE WESTINGHOUSE			30240, 30315,		30240
	20712		20037, 21909		30348, 30352	CROWN	30037, 30072,
TRIDENT	20516	WINDSOR	21037				30278, 30480
TRISTAR	20218	WINDY SAM	20556			CURTIS MATHES	
TRIUMPH	20346, 20516,	WORLD-OF-VISION		AKIBA	30072		30041, 30162
	20556		20865, 20877,	AKURA	30072	CYBERNEX	30240
TVTEXT 95	20556		20880, 20890,	ALBA	30000, 30072,	CYBERPOWER	31972
UHER	20037, 20374,	X-VIEW	21298		30081, 30278,	CYRUS	30081
	20418, 20480,	XENIUS	20634	ALIENWARE	31972	DAEWOO	30045, 30278,
	20486	XLOGIC	20860	ALLSTAR	30081		30352, 30637,
ULTRAVOX	20037	XORO	21196, 21217,	AMERICA ACTION			30642
UNIC LINE	20037, 20455		21243		30278	DANSAI	30072, 30278
UNITED	20037, 20714,	YAMADA	21340	AMSTRAD	30000, 30072,	DANTAX	30352
	20715, 21037	YAMAHA	20650, 20769,		30278	DE GRAAF	30042, 30048,
UNIVERSAL	20037		20797, 21405,	ANAM	30037, 30162,		30081, 30104,
			21406, 21407,		30226, 30240	DECCA	30000, 30067,
		YAMISHI	21576	ANAM NATIONAL			30081, 30352
		YAPSHE	20455		30162, 30226	DEITRON	30278
		YOKAN	20250	ANITECH	30072	DELL	31972
		YOKO	20009, 20037,	ANSONIC	30000	DENKO	30072
			20218, 20264	ARISTONA	30081	DENON	30042
						DIAMANT	30037

DICK SMITH ELECTRONICS		GRUNDIG	30034, 30072, 30081, 30226, 30320, 30347, 30348, 30352	LG	30037, 30480	NIKKO	30037
	30642			LIFETEC	30348	NIKON	30034
DIGITOR	30642			LINKSYS	31972	NIVEUS MEDIA	
DSE	30642			LLOYD'S	30000		31972
DUAL	30000, 30041, 30081, 30278, 30348	HANIMEX	30352	LOEWE	30037, 30081, 30162, 31562	NOBLEX	30240
		HANSEATIC	30037, 30038, 30081	LOGIK	30072, 30106, 30240	NOKIA	30041, 30042, 30048, 30081, 30104, 30106, 30240, 30278, 30315
DUMONT	30000, 30081, 30104	HARLEY DAVIDSON	30000	LUX MAY	30072		
DYNATECH	30000	HARMAN/KARDON		LUXOR	30043, 30048, 30104, 30106, 30315	NORDMENDE	30041, 30067, 30320, 30321
ELBE	30038, 30278		30038, 30081				
ELCATECH	30072	HARWOOD	30072	LXI	30037	NORTHGATE	31972
ELECTROHOME		HCM	30072	M ELECTRONIC		OCEANIC	30000, 30041, 30048, 30081, 30104, 30106
	30037	HEWLETT PACKARD			30000, 30038		
ELECTROPHONIC			31972	MAGNASONIC	30278	OKANO	30072, 30278, 30315, 30348
	30037	HINARI	30041, 30072, 30240, 30278, 30352	MAGNAVOX	30000, 30081, 30642		
ELIN	30240			MAGNIN	30240	OLYMPUS	30226
ELSAY	30072	HISAWA	30352	MAGNUM	30642	ONIMAX	30642
ELTA	30072, 30278	HISCHITO	30045	MANESTH	30045, 30072, 30081	OPTIMUS	30037, 30048, 30104, 30162
EMEREX	30032	HITACHI	30000, 30037, 30041, 30042, 30081, 30166, 30240	MARANTZ	30038, 30081	ORBIT	30072
EMERSON	30000, 30037, 30043, 30045, 30072, 30278, 30637	HOEHER	30278, 30642	MARK	30000, 30278	ORION	30348, 30352
ESC	30240, 30278	HORNYPHON	30081	MARTA	30037	OSAKI	30000, 30037, 30072
FERGUSON	30000, 30041, 30278, 30320, 30321	HOWARD COMPUTERS		MASTEC	30642	OSUME	30072
			31972	MASTER'S	30278	OTTO VERSAND	
FIDELITY	30000, 30072, 30240, 30352	HP	31972	MATSUI	30240, 30348, 30352		30081
FINLANDIA	30000, 30037, 30042, 30043, 30048, 30081, 30104, 30106, 30166, 30226	HUGHES NETWORK SYSTEMS		MATSUSHITA	30162, 30226	PACE	30352
			30042	MEDIA CENTER PC		PACIFIC	30000, 30348, 30642
FINLUX	30000, 30042, 30081, 30104	HUSH	31972	MEDION	30348, 30352, 30642	PACKARD BELL	
FIRSTLINE	30037, 30043, 30045, 30072, 30278, 30348, 30480	HYPSON	30000, 30037, 30072, 30278, 30480	MELECTRONIC		PALLADIUM	30037, 30041, 30072, 30348
		IBUYPOWER	31972		30000, 30037, 30038	PALSONIC	30000, 30072, 30642
FISHER	30104	IMPERIAL	30000	MEMOREX	30000, 30037, 30048, 30104, 30162, 30240, 30307, 30348	PANASONIC	30162, 30226, 30836, 31244, 31562, 31807, 31808, 31809
FLINT	30348	INGERSOLL	30240	MEMPHIS	30072	PATHE CINEMA	
FRONTECH	30072	INNO HIT	30072	METRONIC	30081		30043
FUJI	30033	INTERBUY	30072	METZ	30037, 30081, 30162, 30226, 30347, 30836, 31562	PATHE MARCONI	
FUJITSU	30000, 30045	INTERFUNK	30081, 30104	MGA	30043, 30240		30041
FUNAI	30000	INTERNAL	30278, 30637	MGN TECHNOLOGY		PENNEY	30037, 30038, 30042, 30240
GALAXIS	30278	INTERNATIONAL			30240	PENTAX	30042
GARRARD	30000	INTERNATIONAL	30037, 30278, 30642	MICORMAY	30348	PERDIO	30000
GATEWAY	31972	INTERVISION	30000, 30278	MICROSOFT	31972	PHILCO	30038, 30072
GE	30048, 30240, 30320	IRRADIO	30072, 30081	MIND	31972	PHILIPS	30081
GEC	30081	ITT	30041, 30104, 30106, 30240	MINOLTA	30042	PHOENIX	30278
GENERAL	30045	ITV	30037, 30278	MINOLTA	30042	PHONOLA	30081
GENERAL TECHNIC		JBL	30278	MITSUBISHI	30043, 30048, 30067, 30081, 30480, 30642	PILOT	30037
	30348	JENSEN	30041	MOTOROLA	30048	PIONEER	30042, 30067, 30081, 30162
GENEXXA	30104	JMB	30348, 30352	MTC	30000, 30240	POLK AUDIO	30081
GOLDHAND	30072	JOYCE	30000	MULTITEC	30037	PORTLAND	30278, 30637
GOLDSTAR	30037, 30038, 30480	JVC	30041, 30067, 30206, 31008, 31279	MULTITECH	30000, 30072	PRINZ	30000
GOODMANS	30000, 30037, 30072, 30081, 30278, 30348, 30352, 30637, 30642	KAISUI	30072	MURPHY	30000	PROFITRONIC	
		KAMBROOK	30037	MYRYAD	30081		30081, 30240
GPX	30037	KARCHER	30081, 30278, 30642	NAD	30104	PROLINE	30000, 30278, 30320, 30642
GRADIENSTE	30000	KEC	30037, 30278	NAIKO	30348, 30642	PROSONIC	30278
GRAETZ	30041, 30104, 30240	KENDO	30072, 30106, 30278, 30315, 30348, 30642	NATIONAL	30226	PROTEC	30072
GRANADA	30000, 30037, 30042, 30048, 30081, 30104, 30226, 30240	KENWOOD	30038, 30041, 30067	NEBULA ELECTRONICS		PROTECH	30081
		KLH	30072		30033	PROVISION	30278
GRANDIN	30000, 30037, 30072, 30278	KNEISSEL	30037, 30278, 30348, 30352	NEC	30037, 30038, 30041, 30067, 30104, 30278	PYE	30081
		KODAK	30037	NECKERMANN		QUASAR	30162, 30278
		KORPEL	30072		30081	QUELLE	30081
		KYOTO	30072	NESCO	30072	RADIALVA	30037, 30048
		LENCO	30278	NIKKAI	30072, 30278	RADIOLA	30081
		LEYCO	30072			RADIONETTE	30037
						RADIOSHACK	30000, 30037

RADIX	30037	STACK 9	31972	VECTOR RESEARCH	BASE	41451
RANDEX	30037	STERN	30278	30038	BASIC LINE	40713
RANK ARENA	30041	STS	30042	VICTOR	BAZE	40898, 41165
RCA	30042, 30048, 30106, 30240, 30320	SUNKAI	30278, 30348	VIDEO CONCEPTS	BBK	40862
REALISTIC	30000, 30037, 30048, 30104	SUNSTAR	30000	30045	BEL CANTO DESIGN	41571
REOC	30348	SUNTRONIC	30000	VIDEO TECHNIC	BELLAGIO	41004
REX	30041	SUNWOOD	30072	30000	BLACK DIAMOND	40713, 40766, 40833
RFT	30072	SUPRA	30037	VIDEOMAGIC	40571	
RICAVISION	31972	SYLVANIA	30000, 30043, 30081	VIDEOSONIC	40651, 40672, 40695, 40713, 40804, 40843	
RICOH	30034	SYMPHONIC	30000	VIEWSONIC	41004	
ROADSTAR	30037, 30072, 30081, 30240, 30278	SYSTEMAX	31972	VILLAIN	BLUE PARADE	40571
ROYAL	30072	T+A	30162	VOODOO	BLUE SKY	40651, 40672, 40695, 40713, 40804, 40843
SABA	30041, 30206, 30278, 30320, 30321	TAGAR SYSTEMS	31972	WARDS	BOGHE	41004
SAISHO	30348	31972		30038, 30042, 30045, 30048, 30072, 30081, 30240	BOMAN	40898
SALORA	30043, 30104, 30106	TANDBERG	30278	WATSON	BRAINWAVE	40770, 41115
SAMSUNG	30045, 30240	TANDY	30000, 30104	30081, 30352, 30642	BRANDT	40503, 40651
SANKY	30048	TASHIKO	30000, 30037, 30048, 30081, 30240	WHITE WESTINGHOUSE	BROKSONIC	40695
SANSUI	30000, 30041, 30067, 30072, 30106	TATUNG	30000, 30041, 30043, 30048, 30081, 30348, 30352	30072, 30278, 30637	BUSH	40516, 40672, 40695, 40713, 40730, 40831, 40833, 40879, 41128, 41165
SANYO	30048, 30067, 30104, 30240	TCHIBO	30348	WORLD	CAMBRIDGE AUDIO	41109
SAVILLE	30240, 30278, 30352	TCM	30348	XR-1000	41005	
SBR	30081	TEAC	30000, 30037, 30041, 30278, 30307, 30637, 30642	YAMAHA	CCE	40730
SCHAUB LORENZ	30000, 30041, 30104, 30106, 30315, 30348	TEC	30072	YAMISHI	CELESTIAL	41020
SCHNEIDER	30000, 30037, 30042, 30072, 30081, 30240, 30278, 30348, 30352, 30642	TECH LINE	30072	YOKAN	CENTREX	40672, 41004
SCOTT	30043, 30045	TECHNICS	30081, 30162, 30226	YOKO	CENTRUM	40713, 40779, 41005
SEARS	30000, 30037, 30042, 30104	TEDELEX	30642	ZENITH	CGV	40751, 41115
SEAWAY	30278	TEKNIKA	30000, 30037	30000, 30033, 30034, 30637	CINEA	40831, 40841
SEG	30072, 30081, 30240, 30278, 30637, 30642	TELEAVIA	30041	ZT GROUP	CINETEC	40713
SEI	30081	TELEFUNKEN	30041, 30206, 30278, 30320, 30321, 30642	ZX	CINEVISION	40833, 40869, 41483
SELECO	30037, 30041	TELERENT	30226		CLASSIC	40730
SEMP	30045	TELETECH	30000, 30072, 30278	ACOUSTIC SOLUTIONS	CLATRONIC	40672, 40788, 40818, 41165
SENTRA	30072	TENOSAL	30072	40713, 40730, 41450	CLAYTON	40713
SHARP	30037, 30048	TENSAI	30000, 30072, 30278	AEG	COBY	40730, 40852, 41107, 41165
SHINTOM	30072, 30104	TEVION	30348, 30642	AIRIS	CODEX	41233
SHIVAKI	30037	TEXET	30278	40672, 41005, 41107	COMPACKS	41107, 41265
SHOGUN	30240	THOMAS	30000	AIWA	CONIA	40852
SIEMENS	30037, 30081, 30104, 30320, 30347	THOMSON	30041, 30067, 30278, 30320, 30321	AKAI	CONTINENTAL EDISON	40831
SIERA	30081	THORN	30037, 30041, 30104	40788, 40790, 40898, 41115, 41233	CRAIG	40831
SILVA	30037	TMK	30240	AKI	CROWN	40770, 41115
SILVER	30278	TOKAI	30037, 30072	41005	CRYPTO	41228
SINGER	30045, 30072	TOPLINE	30348	AKURA	CYBERCOM	40831
SINUDYNE	30081, 30352	TOSHIBA	30041, 30042, 30043, 30045, 30081, 30352, 30828, 31008, 31972	ALBA	CYBERHOME	40714, 40816, 41023
SMARAGD	30348	TOTEVISION	30037, 30240	40539, 40672, 40695, 40713, 40730, 41140	CYTRON	40651
SONNECLAIR	30072	TOUCH	31972	ALCO	D-VISION	41115
SONTEC	30037	TOWADA	30072	ALIZE	DAENYX	40872
SONWA	30642	TRADEX	30081	ALL-TEL	DAEWOO	40705, 40714, 40770, 40833, 40869, 40872
SONY	30000, 30032, 30033, 30034, 30106, 31032, 31636, 31972	UHER	30240	ALLEGRO	DAEWOO INTERNATIONAL	40872
SOUNDWAVE	30037, 30348	ULTRAVOX	30278	AMITECH	DALTON	41036, 41107
SSANGYONG	30072	UNITECH	30240	AMPHION MEDIA WORKS	DANSAI	40770, 41115
		UNITED	30348	40872	DANTAX	40539, 40713, 40723, 40790
		UNIVERSUM	30000, 30037, 30081, 30104, 30106, 30240, 30348	AMSTRAD	DAYTEK	40872, 41005
		VECTOR	30045	40713	DAYTON	40872
				AMW	DCE	40831
				ANSONIC	DECCA	40770, 41115
				40759, 40831	DENON	40490, 40634, 41282, 41634
				APEX DIGITAL	DENVER	40788, 40898, 41107, 41165, 41450
				40672, 41004, 41020, 41833	DESAY	40843, 41090
				ARIANET		
				40818		
				AUDIOSONIC		
				41265		
				AUDIOVOX		
				40790		
				AUVIO		
				40843, 41090		
				AVIOUS		
				41165		
				AXION		
				40730		

DVD PLAYER

3D LAB	40539
A-TREND	40714
ACOUSTIC SOLUTIONS	40713, 40730, 41450
AEG	40770, 40788, 40790
AIRIS	40672, 41005, 41107
AIWA	40533, 40641
AKAI	40766, 40770, 40788, 40790, 40898, 41115, 41233
AKI	41005
AKURA	40898, 41140, 41170, 41233, 41367
ALBA	40539, 40672, 40695, 40713, 40730, 41140
ALCO	40790
ALIZE	41151
ALL-TEL	41451
ALLEGRO	40869
AMITECH	40770, 40850
AMOI	40852
AMPHION MEDIA WORKS	40872
AMSTRAD	40713
AMW	40872
ANSONIC	40759, 40831
APEX DIGITAL	40672, 41004, 41020, 41833
ARIANET	40818
AUDIOSONIC	41265
AUDIOVOX	40790
AUVIO	40843, 41090
AVIOUS	41165
AXION	40730

DIAMOND	40651, 40768	HARMAN/KARDON		MATSUI	40651, 40672, 40695, 40713, 41004	PIONEER	40525, 40571, 41571
DICK SMITH ELECTRONICS	40833, 41483	HCM	40788			PLAYGO	41265
DIGATRON	41009	HDT	40705	MAXIM	40713, 40872	PLU2	40850, 41090
DIGIHOME	40713	HENSS	40713	MBO	40730	POLAROID	41020
DIGITOR	41005	HIMAX	40843	MDS	40713	POLK AUDIO	40539
DIGITREX	40672	HITACHI	40573, 40664, 40713	MECOTEK	40770	PORTLAND	40770
DIK	40831			MEDION	40630, 40651, 40831, 40879, 41107, 41345	POWERPOINT	40872
DINAMIC	40788	HITEKER	40672			PRIMA	40766
DISNEY	40675	HOEHER	40651, 40713, 40831	MEI	40790	PRIMA ELECTRONIC	40766
DIVIDO	40705			MEMOREX	40695, 40831	PRINZ	40831
DK DIGITAL	40831	HOME ELECTRONICS	40730	METZ	40525, 40571, 40713	PRISM	40705, 41006
DMTECH	41271					PRO2	41107, 41345
DRAGON	40831	HOME TECH INDUSTRIES	41107, 41451	MICO	40723, 40751, 41223	PROLINE	40651, 40672, 40833, 41004
DREAMX	41151	HOYO	40665			PROSCAN	40522
DSE	40833, 41483	HYUNDAI	40766, 40850, 41228	MICROBOSS	40718	PROSON	40713
DUAL	40651, 40665, 40713, 40730, 40779, 40790, 40831	INGELEN	40788	MICROMEDIA	40503, 40539	QWESTAR	40651
DURABRAND	40713, 40831	INTEGRA	40627	MICROSOFT	40522	RADIONETTE	40741, 40869
EASY HOME	40857	ISP	40695	MICROSTAR	40831	RAITE	40665
ECC	40730	JATON	40665	MINAX	40713	RCA	40522, 40571, 40790
ECLIPSE	40723, 40751	JBL	40702	MINERVA	40705	REC	40490, 40766
ELFUNK	40850	JDB	40730	MINOKA	40770	RED STAR	40759, 40763, 40770, 40788, 40898, 41107, 41345
ELIN	40770	JDV	41367	MINOWA	41165		
ELLION	40850	JMB	40695	MIRROR	40879		
ELTA	40672, 40770, 40788, 40850, 41115, 41151	JVC	40503, 40539, 40558, 40623, 40867	MITSUBISHI	40713, 41521		
				MIZUDA	40770, 40818	REDSTAR	40763, 40898
ELTAX	40766	KANSAI	41107	MONYKA	40665	REOC	40768
EMERSON	40591, 40675, 40705	KANSAS TECHNOLOGIES	41233	MPX	40843	REVOY	40841
				MTLOGIC	41265	RIO	40869
ENTERPRISE	40591	KAWASAKI	40790	MUSTEK	40730	ROADSTAR	40713, 40730, 40818, 40833, 40879, 40898, 41006
ENZER	41228	KENDO	40713, 40831	MX ONDA	40651, 40751, 41223		
EUROLINE	40788, 41115, 41233	KENNEX	40713, 40770, 40898	NAD	40741		
FENNER	40651	KENWOOD	40490, 40534	NAIKO	40770, 41004, 41367	RONIN	40872
FERGUSON	40651, 40898	KIIRO	40770	NEC	40785, 40869	ROTEL	40558, 40623
FINLUX	40591, 40672, 40741, 40751, 40770, 41165	KINGAVON	40818	NEOVIA	41271	ROWA	40516, 40872, 41004
		KISS	40665, 40841, 41523	NEUFUNK	40665	SABA	40651
FIRSTLINE	40713, 40843, 40869	KLH	40790, 41020	NEVIR	40770, 40831, 41197	SAIVOD	40759, 40831, 41367
FISHER	40670	KOSS	40651	NORCENT	40872, 41107, 41265	SALORA	40741
FUNAI	40675, 40695	KXD	40857	NORDMENDE	40831	SAMSUNG	40490, 40573, 40744, 41075
FUSION	40862	LAWSON	40768	NU-TEC	41228	SANSUI	40695, 40751, 40768
GE	40522	LENCO	40651, 40713, 40770, 41165	OLIDATA	40672	SANTOSH	41115
GLOBAL SOLUTIONS	40768	LEXIA	40768	ONKYO	40503, 40627, 40792	SANYO	40670, 40695, 40713, 40873
GO VIDEO	40741, 40744, 40833, 40869, 41075, 41483	LG	40591, 40741, 40790, 40801, 40869	OPTIM	40843	SCAN	40705, 40850
GOLDSTAR	40591, 40741	LIFETEC	40651, 40831	OPTIMUS	40525	SCANMAGIC	40730
GOODMANS	40651, 40713, 40723, 40730, 40790, 40833, 40879, 41004, 41140	LIMIT	40768	ORAVA	40818	SCHAUB LORENZ	40770, 40788, 41115, 41151
		LITEON	41058	ORBIT	40872	SCHNEIDER	40539, 40651, 40705, 40713, 40779, 40788, 40790, 40804, 40831
GRAETZ	40665	LODOS	40713	ORION	40695, 41006, 41128, 41233	SCIENTIFIC LABS	40768
GRAN PRIX	40831, 40898	LOEWE	40511, 40539, 40741	ORITRON	40651	SCOTT	40651, 40672, 40718, 41005, 41036, 41233
GRANDIN	40713, 41233	LOGIX	40705	ORMOND	40713	SEG	40665, 40713, 40763, 40768, 40872
GRUNDIG	40539, 40651, 40670, 40695, 40705, 40713, 40775, 40790, 41004, 41036, 41128	LUKER	41367	P&B	40818, 41451	SHANGHAI	40672
		LUMATRON	40695, 40705, 40741, 40833, 41115	PACIFIC	40695, 40713, 40759, 40768, 40790, 40804, 40831	SHARP	40630, 40675, 40713, 41256
GRUNKEL	40770	LUNATRON	40741	PACKARD BELL	40831	SHERWOOD	40741, 40770
H & B	40818, 40841, 40850, 41233	LUXMAN	40573	PALLADIUM	40695, 40779	SHINSONIC	40533
H&B	40713, 40818, 40841, 40850, 41233	LUXOR	40713, 41004	PALSONIC	40672, 40852	SILVA	40788, 40898
		MAGNAVOX	40503, 40539, 40675, 40713, 41140	PANASONIC	40490, 41282		
HANSEATIC	40741, 40790	MAGNEX	40723, 41165	PARAMOUNT PICTURES	40779		
		MAJESTIC	41107	PEEKTON	40898		
		MANHATTAN	40705, 40713	PHILCO	40788		
		MARANTZ	40539	PHILIPS	40503, 40539, 40675		
		MARK	40713	PHILO	41345		
		MARQUANT	40770	PHONOTREND	41165		

SILVA SCHNEIDER 40831, 40898
 SINGER 40751
 SKANTIC 40539, 40713
 SKYMASTER 40730, 40768
 SKYWORTH 40766, 40898
 SLIDING 41115
 SM ELECTRONIC 40730, 40768
 SMART 40705, 40713, 40718
 SONIC BLUE 40869
 SONY 40533, 40573, 40772, 40864, 41033, 41633
 SOUND COLOR 41233
 SOUNDMASTER 40768
 STANDARD 40651, 40768, 40788, 40831, 40898
 STARLOGIC 41005
 STARMEDIA 40818, 41005
 STEVISON 41367
 STRONG 40713
 SUNKAI 40770, 40850
 SUNSTECH 40831
 SUNWOOD 40788, 40898
 SUPERVISION 40768
 SVA 40672
 SYLVANIA 40675
 SYMPHONIC 40675
 SYNNA 40768
 TANDBERG 40713
 TATUNG 40770
 TEAC 40516, 40571, 40695, 40741, 40759, 40768, 40790, 40809, 40833, 41006, 41197, 41483
 TEC 40898
 TECHNICS 40490
 TECHNIKA 40770, 40831, 41115, 41165
 TECHNISSON 41115
 TECHNOSONIC 40730, 41115
 TECHWOOD 40713
 TEDELEX 41228
 TELETECH 40713, 40768
 TENSAN 40651, 40770
 TEVION 40651, 40833, 40898, 41036, 41170, 41382
 THETA DIGITAL 40571
 THOMSON 40522
 TOKAI 40665, 40788, 40790, 40898
 TOM-TEC 41450
 TOSHIBA 40503, 40695
 TRANS-CONTINENTS 40831, 40872, 41165, 41327
 TREDEX 40804, 40843
 TRUVISION 40857
 UMAX 41151
 UNITED 40672, 40695, 40788, 41115, 41165, 41228
 UNIVERSUM 40591, 40713, 40741, 40779, 40790, 40869

UPTK 40763
 UPXUS 41345
 URBAN CONCEPTS 40503
 VENTURER 40790
 VESTEL 40713
 VIETA 40705, 41265
 VIEWMASTER 40862
 VOXSON 40730, 40831
 VTREK 41228
 WAITEC 41151
 WELKIN 40831
 WELLINGTON 40713
 WELTSTAR 40713
 WHARFEDALE 40751, 40790
 WILSON 40831, 41233
 WINDSOR 40713
 WINDY SAM 40573
 WOXTER 41005, 41151
 XBOX 40522
 XENIUS 40790
 XLOGIC 40768
 XMS 40770
 XORO 41183
 YAKUMO 41004
 YAMADA 40872, 41004, 41151
 YAMAHA 40490, 40539, 41282, 41543
 YAMAKAWA 40665, 40872
 YUKAI 40730
 ZENITH 40503, 40591, 40741, 40869
 ZENNOX 41265
 ZOECE 41265

LD PLAYER

AIWA 40203
 CARVER 40064, 40194
 DENON 40059
 FUNAI 40203
 HARMAN/KARDON 40194
 HITACHI 40395
 KENWOOD 40258
 MAGNAVOX 40194, 40217
 MARANTZ 40064, 40194
 MITSUBISHI 40059
 NAD 40059
 NAGSMI 40059
 OPTIMUS 40059
 PANASONIC 40204
 PHILIPS 40064, 40194
 PIONEER 40059
 POLK AUDIO 40194
 QUASAR 40204
 REALISTIC 40203
 SALORA 40064
 SHARP 40001
 SONY 40193, 40201
 TECHNICS 40204
 TELEFUNKEN 40059
 THETA DIGITAL 40194
 VICTOR 40245
 WARDS 40059
 YAMAHA 40217

DVD RECORDER

APEX DIGITAL 51056
 BOGHE 51221
 DENON 50490

DICK SMITH ELECTRONICS 51730
 DIGITREX 51056
 DSE 51730
 ELTAX 51321
 FUNAI 50675
 GATEWAY 51158
 GO VIDEO 50741, 51158, 51730
 H & B 51235, 51421
 HITACHI 51664
 JVC 51164, 51275
 KREISEN 51421
 LG 50741
 LITEON 51158, 51416, 51440, 51456
 LOEWE 50741
 MAGNAVOX 50646
 MEDION 51347
 MICO 51221
 MITSUBISHI 51403
 MUSTEK 51730
 NEC 51404
 PANASONIC 50490, 51010, 51011
 PHILIPS 50646, 51158, 51818
 PIONEER 50631, 51475, 51476
 RCA 50522
 RELISYS 51347
 SAMSUNG 50490
 SENSORY SCIENCE 51158
 SHARP 50630, 50675, 51419, 51550, 51556
 SINUDYNE 51221
 SONY 51033, 51069, 51070, 51433
 SYLVANIA 50675
 TANGENT 51321
 TEVION 51227
 THOMSON 50551
 TOSHIBA 51510
 VICTOR 51275
 XORO 51221
 YAMADA 51056, 51158, 51416
 YAMAHA 51544
 ZENITH 50741

CD PLAYER

ADC 60018
 ADCOM 60234
 ADVANTAGE 60032
 AIWA 60157
 AKAI 60156, 60362, 60643
 ALTO 60625
 ANAM 60362
 ARCAM 60157
 ARISTON 60625
 AUDIO DYNAMICS 60018
 AUDIO RESEARCH 60157
 AUDIOLAB 60157
 AUDIOMECA 60157
 AUDIOTON 60157
 BUSH 60643
 CAIRN 60157
 CALIFORNIA AUDIO LABS 60029, 60303
 CAMBRIDGE 60157, 60625

CAMBRIDGE AUDIO 60625
 CARVER 60157, 60179, 60299
 CCE 60643
 COPLAND 60393
 CYRUS 60157
 DENON 60003, 60034, 60626
 DKK 60000
 DMX ELECTRONICS 60157
 DUAL 60003
 ECLIPSE 60625
 EROICA 60481
 FIDELITY 60625
 FISHER 60179
 GARRARD 60393, 60643
 GEMINI 60625
 GENEXXA 60032, 60426
 GOLDMUND 60157
 GOLDSTAR 60643
 GOODMAN'S 60362, 60625
 GRUNDIG 60157
 GTX 60362
 HARMAN/KARDON 60157, 60173, 60426
 HCM 60625
 HIRO 60625
 HITACHI 60032
 INTEGRA 60101
 KENWOOD 60028, 60157, 60190, 60626
 KRELL 60157
 KYOCERA 60018
 LINN 60157
 LG 71208
 LOEWE 60157
 LUXMAN 60093
 MAGNAVOX 60157
 MARANTZ 60029, 60157, 60626
 MATSUI 60157, 60643
 MCS 60029
 MEMOREX 60032
 MERIDIAN 60157
 MICROMEGA 60157
 MIRO 60000
 MISSION 60157
 MITSUBISHI 60156
 MTC 60625
 MUSICAL FIDELITY 60393
 MYRYAD 60157
 NAD 60000, 60299, 60721
 NAGAOKA 60018
 NAIM 60157
 NAKAMICHI 60147
 NEC 60234
 NIKKO 60362, 60625
 NSM 60157
 ONKYO 60101, 61327
 OPTIMUS 60000, 60032, 60179, 60426
 ORION 60393
 PANASONIC 60029, 60303
 PHILIPS 60157, 60626
 PINK TRIANGLE 60625
 PIONEER 60032, 60101
 POLK AUDIO 60157
 PRONON 60157
 QED 60157

QUAD 60157
 QUASAR 60029
 RADIOLA 60157
 RADIOTONE 60625
 RCA 60032, 60179
 REALISTIC 60179
 RESTEK 60157
 REVOX 60157
 ROTEL 60157, 60897
 SAE 60157
 SAMSUNG 60524
 SANSUI 60157, 60625
 SANYO 60179
 SEG 60625
 SHARP 60034
 SHERWOOD 60426
 SIEMENS 60157, 60362
 SIMAUDIO 60157
 SONIC FRONTIERS 60157
 SONY 60000
 STS 60018
 SUPERTECH 60625
 SYNERGY 60625
 TAG MCLAREN 60157
 TANDY 60032
 TEAC 60362, 60393,
 60625, 60643
 TECHNICS 60029, 60207,
 60303
 TECHWOOD 60362
 THORENS 60157
 THULE AUDIO 60157
 TOSHIBA 60299, 60481
 TRAXDATA 60626
 UNIVERSUM 60157, 60362,
 60524
 WARDS 60000, 60032,
 60157, 60179
 YAMAHA 60036, 61907
 YBA 60625

CD RECORDER

DENON 70626, 70766
 HHB 70192

JVC 71294
 KENWOOD 70626
 LG 71208
 MARANTZ 70626
 NAD 71208
 PHILIPS 70626
 PIONEER 70192, 71087
 RCA 70420
 SONY 70000
 TDK 71208
 TEAC 70420
 VICTOR 70072, 71294
 YAMAHA 70888, 71292

MD RECORDER

DENON 70873
 KENWOOD 70681
 OPTIMUS 71063
 PIONEER 71063
 SHARP 70861, 71684
 SONY 70490
 TECHNICS 71078
 YAMAHA 70490, 70888,
 71909

TAPE DECK

AIWA 70029, 70197
 AKAI 70189, 70283
 ARCAM 70076
 CARVER 70029
 DENON 70076
 EROICA 70189
 GARRARD 70308, 70309
 GRUNDIG 70029
 HARMAN/KARDON 70029
 INKEL 70070
 JVC 70244, 70273
 KENWOOD 70070, 70205
 MAGNAVOX 70029
 MARANTZ 70029
 MITSUBISHI 70189, 70283
 MYRYAD 70029
 ONKYO 70135, 70282
 OPTIMUS 70027, 70220

ORION 70308, 70309
 PANASONIC 70229
 PHILIPS 70029, 70229
 PIONEER 70027, 70220
 POLK AUDIO 70029
 RADIOLA 70029
 RCA 70027, 70220
 REVOX 70029
 SANSUI 70029
 SHARP 70205, 70231
 SONY 70170, 70243
 TEAC 70283, 70289,
 70308, 70309
 TECHNICS 70229
 THORENS 70029
 VICTOR 70244, 70273
 WARDS 70027, 70029
 YAMAHA 70097, 70205,
 70524

TUNER

ACOUSTIC SOLUTIONS 81467
 AIWA 80158, 80189
 AKAI 80115, 80609
 ANAM 80281, 80609
 ARCAM 80189
 CAIRN 80189
 CAMBRIDGE 80189
 CAMBRIDGE AUDIO 81455, 81647
 CARVER 80189
 DENON 80004, 80273
 DUAL 80004
 GARRARD 80281
 GOLDMUND 80189
 GOLDSTAR 80281
 GOODMAN'S 80609
 GRADIENTE 80281
 GRUNDIG 80189, 80281
 HARMAN/KARDON 80110, 80189
 INKEL 80027, 80066
 JBL 80110
 JVC 80074
 KENWOOD 80027, 80645

LG 80281
 LINN 80189
 LOEWE 80189
 MAGNAVOX 80189
 MARANTZ 80189
 MEMOREX 80014
 MICROMEGA 80189
 MUSICAL FIDELITY 80445
 MYRYAD 80189
 NAD 80320, 80609
 NIKKO 80609
 ONKYO 80103, 80119
 PANASONIC 80309, 80518
 PHILIPS 80189
 PIONEER 80014
 POLK AUDIO 80189
 RADIOLA 80189
 RESTEK 80189
 REVOX 80140, 80189
 SANSUI 80189, 80609
 SHERWOOD 80066
 SIEMENS 80609
 SONIC 80281
 SONY 80158
 SOUNDWAVE 80609
 TEAC 80110, 80609
 TECHNICS 80309, 80518,
 81135
 TECHWOOD 80281, 80609
 THORENS 80189
 UNIVERSUM 80189, 80281,
 80609
 VICTOR 80074
 WARDS 80014, 80158,
 80189
 YAMAHA 80293, 81908
 (TUNER ID1) 81916
 (TUNER ID2) 81917
 ZENITH 80281

OTHER AUDIO ACCESSORIES

YAMAHA (iPod) 81981



© 2006 YAMAHA CORPORATION All rights reserved.

YAMAHA ELECTRONICS CORPORATION, USA 6660 ORANGETHORPE AVE., BUENA PARK, CALIF. 90620, U.S.A.
 YAMAHA CANADA MUSIC LTD. 135 MILNER AVE., SCARBOROUGH, ONTARIO M1S 3R1, CANADA
 YAMAHA ELECTRONIK EUROPA G.m.b.H. SIEMENSSTR. 22-34, 25462 RELLINGEN BEI HAMBURG, GERMANY
 YAMAHA ELECTRONIQUE FRANCE S.A. RUE AMBROISE CROIZAT BP70 CROISSY-BEAUBOURG 77312 MARNE-LA-VALLEE CEDEX02. FRANCE
 YAMAHA ELECTRONICS (UK) LTD. YAMAHA HOUSE, 200 RICKMANSWORTH ROAD WATFORD, HERTS WD18 7GQ, ENGLAND
 YAMAHA SCANDINAVIA A.B. J A WETTERGRENS GATA 1, BOX 30053, 400 43 VÄSTRA FRÖLUNDA, SWEDEN
 YAMAHA MUSIC AUSTRALIA PTY, LTD. 17-33 MARKET ST., SOUTH MELBOURNE, 3205 VIC., AUSTRALIA

YAMAHA CORPORATION
 Printed in Malaysia ◀ WG73810