

YAMAHA

KX-493/KX-393

Natural Sound Stereo Cassette Deck
Platine à cassette stéréo de la série "Natural Sound"

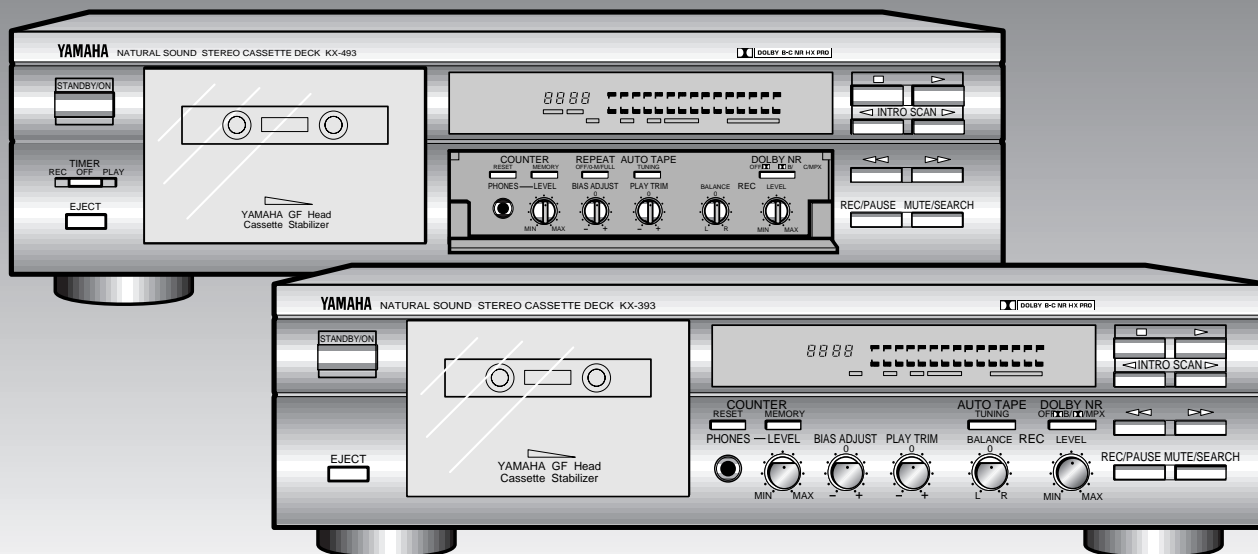

OWNER'S MANUAL
MODE D'EMPLOI

Thank you for purchasing this YAMAHA stereo cassette deck.

SAFETY INSTRUCTIONS

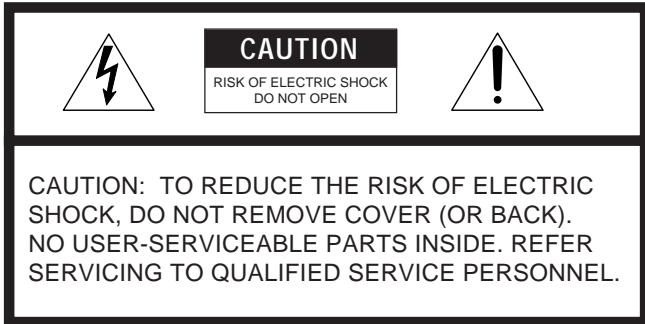

● Explanation of Graphical Symbols



The lightning flash with arrowhead symbol, within an equilateral triangle, is intended to alert you to the presence of uninsulated "dangerous voltage" within the product's enclosure that may be of sufficient magnitude to constitute a risk of electric shock to persons.



The exclamation point within an equilateral triangle is intended to alert you to the presence of important operating and maintenance (servicing) instructions in the literature accompanying the appliance.

WARNING

TO REDUCE THE RISK OF FIRE OR ELECTRIC SHOCK, DO NOT EXPOSE THIS APPLIANCE TO RAIN OR MOISTURE.

- 1** Read Instructions — All the safety and operating instructions should be read before the unit is operated.
- 2** Retain Instructions — The safety and operating instructions should be retained for future reference.
- 3** Heed Warnings — All warnings on the unit and in the operating instructions should be adhered to.
- 4** Follow Instructions — All operating and other instructions should be followed.
- 5** Water and Moisture — The unit should not be used near water — for example, near a bathtub, washbowl, kitchen sink, laundry tub, in a wet basement, or near swimming pool, etc.
- 6** Carts and Stands — The unit should be used only with a cart or stand that is recommended by the manufacturer.

6A An appliance and cart combination should be moved with care. Quick stops, excessive force, and uneven surfaces may cause the unit and cart combination to overturn.



7 Wall or Ceiling Mounting — The unit should be mounted to a wall or ceiling only as recommended by the manufacturer.

8 Ventilation — The unit should be situated so that its location or position does not interfere with its proper ventilation. For example, the unit should not be situated on a bed, sofa, rug or similar surfaces that may block the ventilation openings; or placed in a built-in installation, such as a bookcase or cabinet that may impede the flow of air through the ventilation openings.

9 Heat — The unit should be situated away from heat sources such as radiators, stoves, or other units that produce heat.

10 Power Sources — The unit should be connected to a power supply only of the type described in the operating instructions or as marked on the unit.

11 Power-Cord Protection — Power-supply cords should be routed so that they are not likely to be walked on or pinched by items placed upon or against them, paying attention to receptacles, and the point where they exit from the unit.

12 Cleaning — The unit should be cleaned only as recommended by the manufacturer.

13 No Use Periods — The power cord of the unit should be unplugged from the outlet when left unused for a long period of time.

14 Object and Liquid Entry — Care should be taken so that objects do not fall into and liquids not spilled into the inside of the unit.

15 Damage Requiring Service — The unit should be serviced by qualified service personnel when:

- A.** The power-supply cord or the plug has been damaged; or
- B.** Objects have fallen, or liquid has been spilled into the unit; or
- C.** The unit has been exposed to rain; or
- D.** The unit does not appear to operate normally or exhibits a marked change in performance; or
- E.** The unit has been dropped, or the cabinet damaged.

16 Servicing — The user should not attempt to service the unit beyond those means described in the operating instructions. All other servicing should be referred to qualified service personnel.

17 Grounding or Polarization — The precautions should be taken so that the grounding or polarization of an unit is not defeated.

This unit is not disconnected from the AC power source as long as it is connected to the wall outlet, even if the unit itself is turned off. This state is called the standby mode. In this state, the unit is designed to consume a very small quantity of power.

FCC INFORMATION (U.S.A.)

1. IMPORTANT NOTICE: DO NOT MODIFY THIS UNIT!

This product, when installed as indicated in the instructions contained in this manual, meets FCC requirements. Modifications not expressly approved by Yamaha may void your authority, granted by the FCC, to use the product.

2. IMPORTANT: When connecting this product to accessories and/or another product use only high quality shielded cables. Cables supplied with this product MUST be used. Follow all installation instructions. Failure to follow instructions could void your FCC authorization to use this product in the USA.

3. NOTE: This product has been tested and found to comply with the requirements listed in FCC Regulations, Part 15 for Class "B" digital devices. Compliance with these requirements provides a reasonable level of assurance that your use of this product in a residential environment will not result in harmful interference with other electronic devices. This equipment generates/uses radio frequencies and, if not installed and used according to the instructions found in the users manual, may cause interference harmful to the operation of other electronic devices. Compliance with FCC regulations does not guarantee that interference will not occur in all installations. If this product is found to be the source of interference, which can be determined by turning the product "OFF" and "ON", please try to eliminate the problem using one of the following measures:

Relocate this product or the device that is being affected by the interference.

Utilize power outlets that are on different branch (circuit breaker or fuse) circuits or install AC line filter/s.

In the case of radio or TV interference, relocate/reorient the antenna. If the antenna lead-in is 300 ohm ribbon lead, change the lead-in to coaxial type cable.

If these corrective measures do not produce satisfactory results, please contact your local retailer that is authorized to distribute this type of product. If you cannot locate the appropriate retailer, please contact Yamaha Electronics Corp., U.S.A.
6660 Orangethorpe Ave, Buena Park, CA 90620

The above statements apply ONLY to those products distributed by Yamaha Corporation of America or its subsidiaries.

CAUTION: READ THIS BEFORE OPERATING YOUR UNIT.

1. This unit is a sophisticated stereo cassette deck. To ensure proper operation for the best possible performance, please read this manual carefully.
2. Choose the installation location of your unit carefully. Avoid placing it in direct sunlight or close to source of heat. Also avoid locations subject to vibration and excessive dust, heat, cold or moisture. Keep it away from sources of hum such as transformers or motors.
3. Do not open the cabinet as this may result in damage to the deck or electrical shock. If a foreign object should get into the deck, contact your local dealer.
4. When removing the power plug from the wall outlet, always pull directly on the plug; never pull the cord itself.
5. Do not apply excessive force when operating switches and knobs.
6. When moving the deck, be sure to first pull out the power plug and remove all cords connecting the deck to other equipment.
7. Do not attempt to clean this unit with chemical solvents as this may damage the finish. Use a clean, dry cloth.
8. Never allow metallic items (e.g. screwdrivers, tools, etc.) to come near the record/playback head assembly. Doing so may not only scratch or damage the head's mirror-smooth finish, it may also change the magnetic characteristics of the heads, causing a deterioration in reproduction quality.
9. Although the record/playback head used in this unit is a high quality head with outstanding reproduction characteristics, it can become dirty through the use of old tapes or from dust accumulation over time. This can have a serious effect on reproduction quality. Clean the heads regularly with one of the commonly available head cleaners or with cleaning solutions as explained later in this manual.
10. Be sure to read the "TROUBLESHOOTING" section of this manual for advice on common operating errors before concluding that your unit is faulty.
11. Keep this manual in a safe place for future reference.
12. **Voltage Selector (General model only)**
The voltage selector on the rear panel of this unit must be set for your local mains voltage BEFORE plugging in the AC mains supply. (Voltage selector adjustable between 110/120/220/240 V AC.)

Note

Please check the copyright laws in your country to record from records, compact discs, radio, etc. Recording of copyright material may infringe copyright laws.

We Want You Listening For A Lifetime

YAMAHA and the Electronic Industries Association's Consumer Electronics Group want you to get the most out of your equipment by playing it at a safe level. One that lets the sound come through loud and clear without annoying blaring or distortion – and, most importantly, without affecting your sensitive hearing.

Since hearing damage from loud sounds is often undetectable until it is too late, YAMAHA and the Electronic Industries Association's Consumer Electronics Group recommend you avoid prolonged exposure to excessive volume levels.



FOR CANADIAN CUSTOMERS

TO PREVENT ELECTRIC SHOCK, MATCH WIDE BLADE OF PLUG TO WIDE SLOT AND FULLY INSERT.

THIS CLASS B DIGITAL APPARATUS MEETS ALL REQUIREMENTS OF THE CANADIAN INTERFERENCE-CAUSING EQUIPMENT REGULATIONS.

This owner's manual covers YAMAHA cassette deck models KX-493 and KX-393. Please check which model you have purchased and read the sections that apply to your particular model. There may be some unnecessary items, so please skip them accordingly.

TABLE OF CONTENTS

<p>FEATURES 4</p> <p>CONNECTIONS 4</p> <p>PLAYBACK 5</p> <p style="padding-left: 20px;">SELECTION SEARCH 7</p> <p style="padding-left: 20px;">INTRO SCAN 7</p> <p style="padding-left: 20px;">MEMORY STOP OPERATION 8</p> <p style="padding-left: 20px;">REPEAT PLAYBACK (KX-493 only) 8</p> <p>RECORDING 9</p> <p style="padding-left: 20px;">REC MUTE OPERATION 12</p> <p style="padding-left: 20px;">0-STOP OPERATION 12</p> <p style="padding-left: 20px;">REC RETURN OPERATION 12</p>	<p>TIMER RECORDING/PLAYBACK (KX-493 only) 13</p> <p style="padding-left: 20px;">Timer recording 13</p> <p style="padding-left: 20px;">Timer playback 13</p> <p>CASSETTE TAPES 14</p> <p>OPENING AND CLOSING THE SUB PANEL (KX-493 only) 15</p> <p>OPTIONAL REMOTE CONTROL TRANSMITTER 15</p> <p>MAINTENANCE 15</p> <p>TROUBLESHOOTING 16</p> <p>SPECIFICATIONS 17</p>
--	---

FEATURES

- Dolby HX Pro Dynamic Bias Servo
- Dolby B/C Noise Reduction
- Secure Holding Damper Cassette Stabilizer allows you to reduce unwanted vibration and modulation noise
- Fine Adjustment of Recording Characteristics with Auto Tape Tuning and Bias Adjust Control
- 160 kHz High Recording Bias prevents cross modulation beat distortion that can occur between the recording bias and the recording signal's high frequency content (KX-493 only)
- Play Trim Control for improved playback compatibility with other decks
- 0-M/FULL Repeat Playback (KX-493 only), Selection Search and Bi-Directional Intro Scan
- Recording Mute function

CONNECTIONS

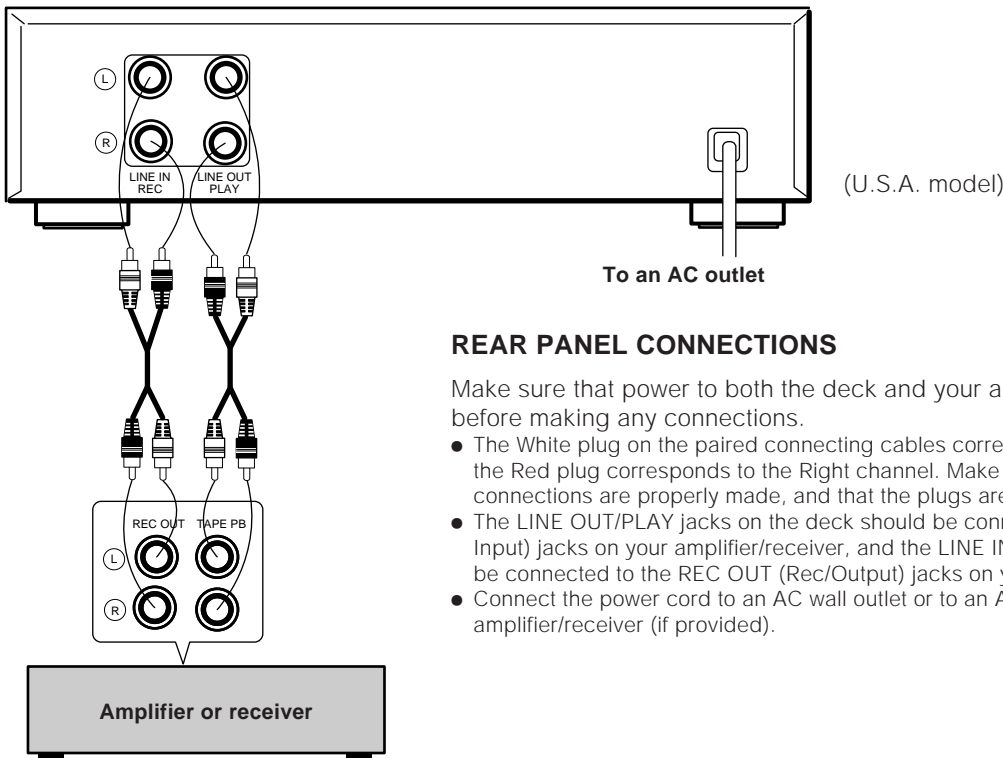

REAR PANEL CONNECTIONS

Make sure that power to both the deck and your amplifier/receiver are turned off before making any connections.

- The White plug on the paired connecting cables corresponds to the Left channel and the Red plug corresponds to the Right channel. Make sure that the left and right channel connections are properly made, and that the plugs are inserted firmly.
- The LINE OUT/PLAY jacks on the deck should be connected to the TAPE PB (Playback/ Input) jacks on your amplifier/receiver, and the LINE IN/REC jacks on the deck should be connected to the REC OUT (Rec/Output) jacks on your amplifier/receiver.
- Connect the power cord to an AC wall outlet or to an AC outlet on the rear panel of your amplifier/receiver (if provided).

PLAYBACK

Preparation for playback

- Be sure to set the **TIMER** switch to the OFF position (KX-493 only), then turn on the **STANDBY/ON** switch.
- Set your amplifier or receiver to cassette deck function mode.

KX-493

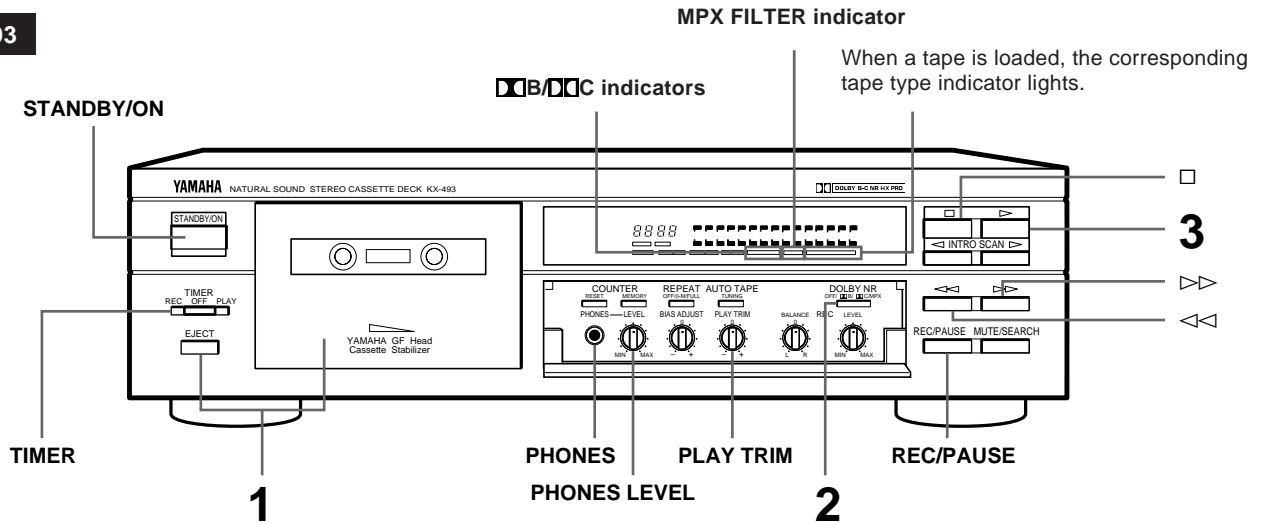

KX-393

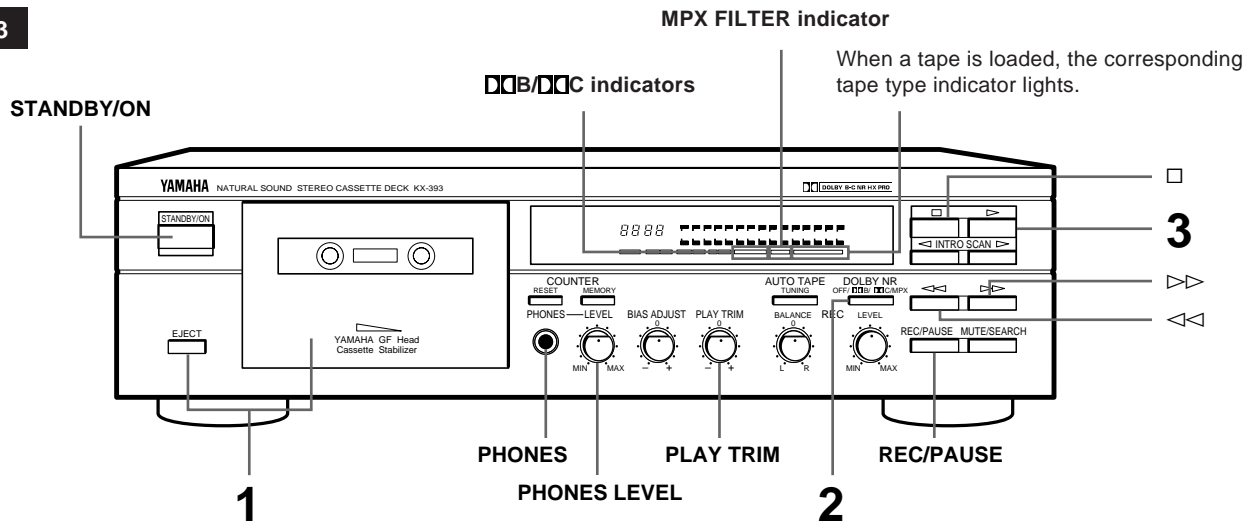

Press **STANDBY/ON** to turn this unit on. Press again to set it to the standby mode.
Please note that this unit is designed to consume a very small quantity of power when set to the standby mode.

1

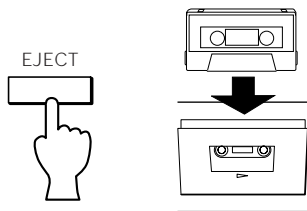

Insert the cassette with the exposed tape side facing down and the side to be played facing you. To close the compartment, push in the compartment door until it locks shut.

2

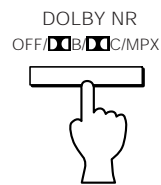

See next page.

3

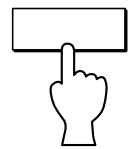

To stop playback:

Press the button.

To fast forward the tape:

Press the button.

To fast rewind the tape:

Press the button.

To adjust the volume level:

Use the volume control of the amplifier or receiver.

To use headphones for private listening:

Insert the headphones plug into the **PHONES** jack.

To adjust the headphones level:

Use the **PHONES LEVEL** control.

DOLBY NR button setting (in step 2)

DOLBY NR (OFF/ B/ C/MPX) button

Be sure to set the **DOLBY NR (OFF/ B/ C/MPX)** button according to the system used for recording. Each time this button is pressed, Dolby NR switches as follows:

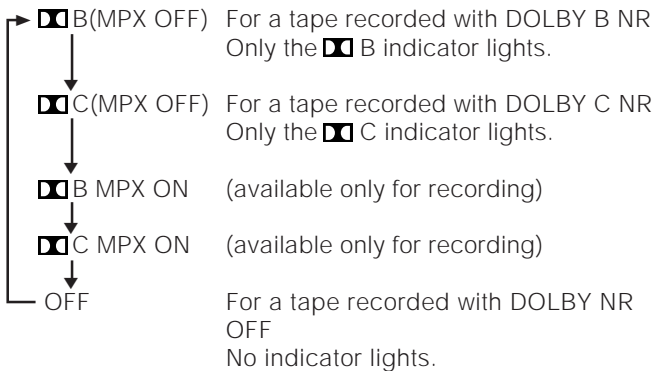

Note: The MPX filter settings are explained on page 9.

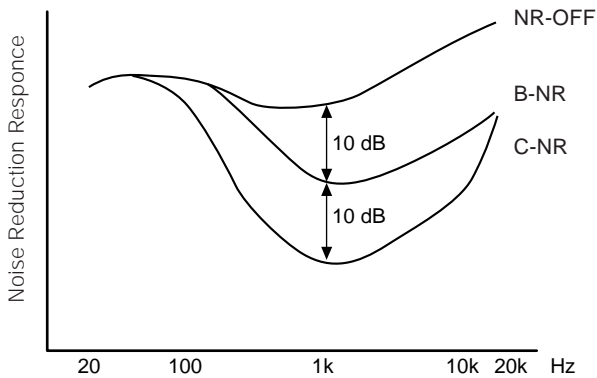

PLAY TRIM control adjustment

When the level of high frequencies is too boosted or absent while playing a tape recorded on another cassette deck, adjust the high frequency response with the **PLAY TRIM** control.

When high frequencies are too boosted, attenuate the high frequencies.

When high frequencies are absent, boost the high frequencies.

KX-493

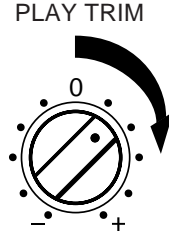
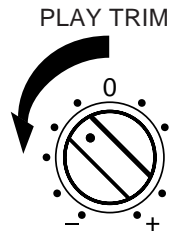

KX-393

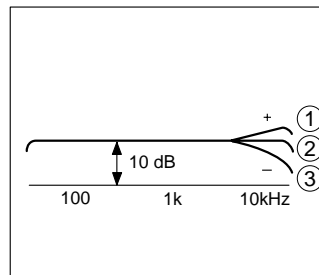
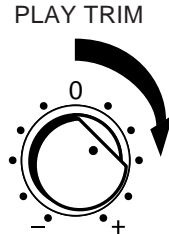
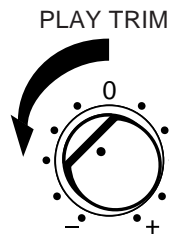

- ① High frequency sound is too boosted.
- ② Flat.
- ③ High frequency sound is absent.

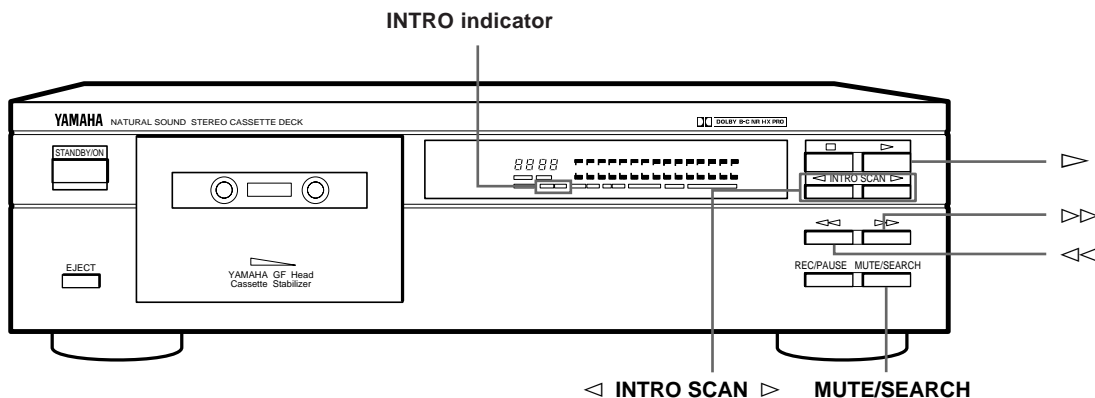

SELECTION SEARCH - To play back a desired selection by searching for the beginning of the selection

<p>To search for the next selection</p> <p>▷▷ + MUTE/SEARCH</p>	<p>To search for the beginning of the current selection</p> <p>◁◁ + MUTE/SEARCH</p>	<p>To search for the selection located before the current selection</p> <p>When the beginning of the current selection is played:</p> <p>◁◁ + MUTE/SEARCH</p>
<p>The ◁◁ or ▷▷ button and the MUTE/SEARCH button should be pressed simultaneously.</p>		

INTRO SCAN - To play back the beginning of each selection automatically

<p>To play back each selection in the reverse direction:</p> <p>The INTRO ◁ indicator lights during reverse intro scan.</p> <p>◁ INTRO SCAN</p>	<p>To play back each selection in the forward direction:</p> <p>The INTRO ▷ indicator lights during forward intro scan.</p> <p>INTRO SCAN ▷</p>	<p>To resume normal playback when the desired selection is found:</p> <p>▷</p>
---	---	--

Notes on Selection search and Intro scan

- The blank interval between selections must be at least 4 seconds.
- Selection search and Intro scan may not operate properly with tapes recorded with a low record level or with excessive noise.

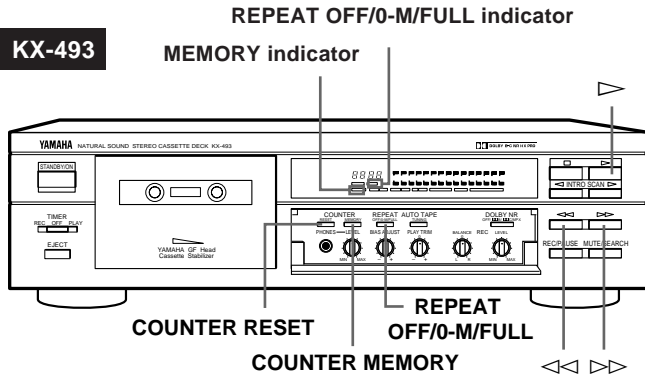
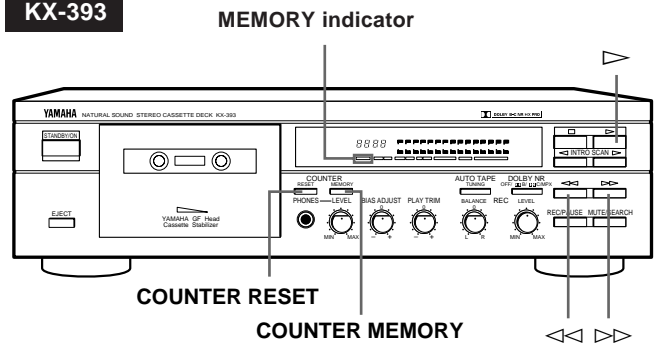
KX-493**KX-393**

MEMORY STOP OPERATION - To return to the desired position

Pressing the **MEMORY** button memorizes the desired counter reading. The MEMORY indicator lights.

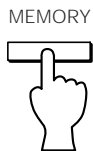

During fast forwarding or rewinding, the tape will stop at the counter reading point where the **MEMORY** button was pressed.

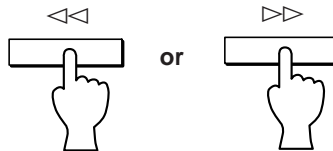

To cancel the memorized counter reading, press the **MEMORY** button again. The MEMORY indicator goes out.

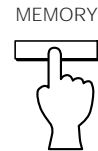

REPEAT PLAYBACK (**KX-493** only)

0-M (a section) repeat

With this function, a desired section can be played repeatedly up to 8 times.

- 1 Press the **REPEAT OFF/0-M/FULL** button so that the REPEAT 0-M indicator lights.



- 2 Press the **RESET** button at the beginning of the section you want to play repeatedly. The counter on the display is reset to "0000".

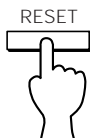

- 3 Press the **MEMORY** button at the end of the section during playback. The MEMORY indicator on the display lights up, and the tape immediately begins rewinding.

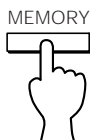

The tape is rewound until the counter has returned to the beginning of the section. The deck then enters the playback mode and the specified section is played repeatedly.

Note:

The length between the start and end points of the 0-M repeat section should be more than 4 counts.

Full repeat

With this function, the cassette side being played can be repeated up to 8 times.

Press the **REPEAT OFF/0-M/FULL** button so that the REPEAT FULL indicator lights.

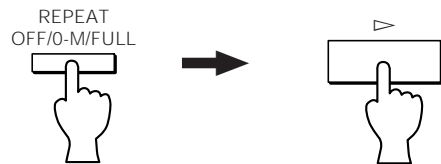

To cancel repeat playback

To cancel the 0-M repeat or Full repeat, press the **REPEAT OFF/0-M/FULL** button so that both REPEAT 0-M and REPEAT FULL indicators go off. Each time this button is pressed, Repeat mode switches as follows:



RECORDING

Preparation for recording

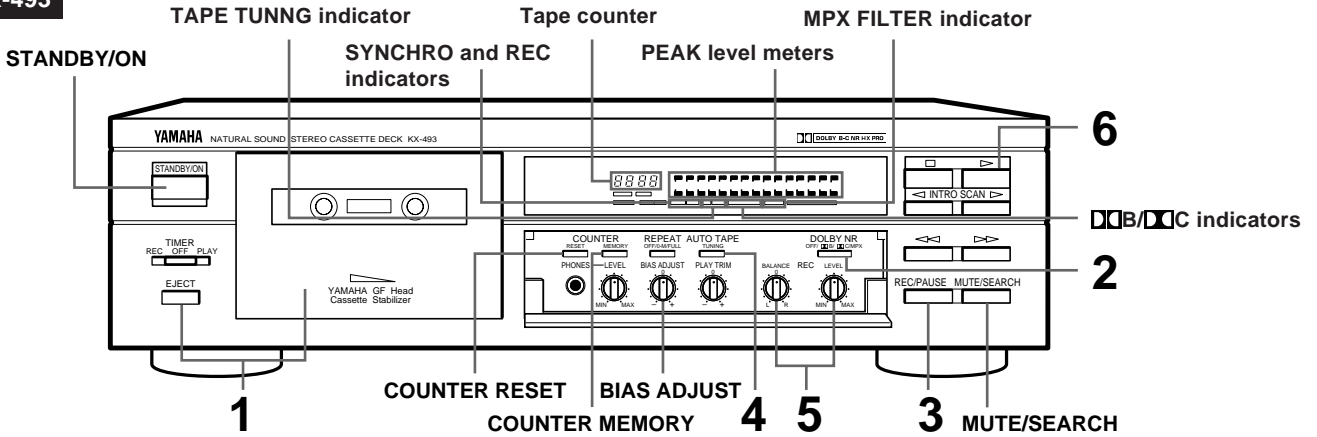

- Be sure to set the **TIMER** switch to the OFF position (KX-493 only), then turn on the **STANDBY/ON** switch.
- Set your amplifier or receiver to cassette deck function mode.

KX-493

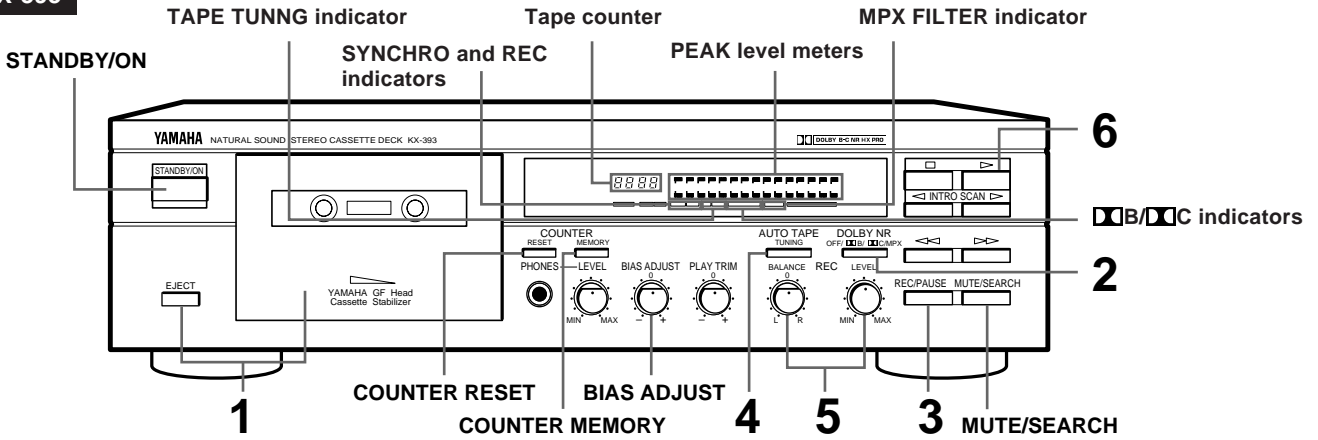

KX-393

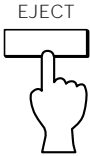
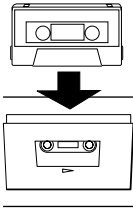
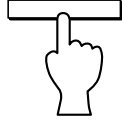
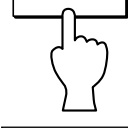

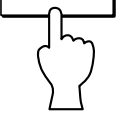
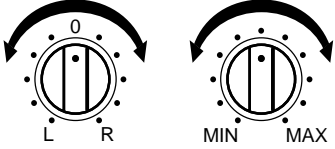
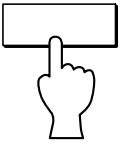
<p>1</p>   <p>Insert the cassette with the exposed tape side facing down and the side to be recorded facing you. To close the compartment, push in the compartment door until it locks shut.</p>	<p>2</p>  <p>See next page.</p>	<p>3</p>   <p>Play the program source to be recorded.</p>
<p>4</p>  <p>See "AUTO TAPE TUNING button" (page 10).</p>	<p>5</p>  <p>Shape of REC controls are slightly different with KX-393. See "Setting the recording level" (page 11).</p>	<p>6</p> 

To stop recording:

Press the □ button.

To stop recording temporarily:

Press the **REC/PAUSE** button. To resume recording, press the ▷ button.

Tape counter and COUNTER RESET button

Before starting recording, press the **RESET** button to set the counter reading to "0000". Use this counter to aid in locating a point on a tape.

DOLBY NR button setting (in step 2)
DOLBY NR (OFF/□□B/□□C/MPX) button

Each time this button is pressed, Dolby NR switches as follows:

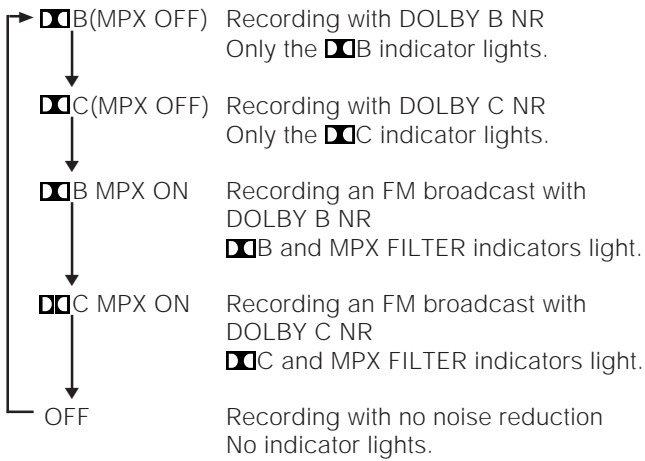

● **MPX filter:**

FM stations transmit a 19 kHz pilot signal in addition to the broadcast program. Sometimes this pilot signal may leak into the audio output depending on the tuner and broadcast conditions. This signal can cause improper operation of the Dolby NR systems. Activating the MPX filter (B TYPE/C TYPE MPX ON settings) will effectively remove the signal.

AUTO TAPE TUNING button (in step 4)

Pressing this button during the REC/PAUSE mode will activate the Auto Tape Tuning that makes it possible to internally determine the optimum recording characteristics (bias and recording sensitivity) according to the loaded cassette tape in about 20 seconds.

To perform the Auto Tape Tuning, send the tape leader part forward and set the **PLAY/TRIM** control and the **BIAS ADJUST** control to the center position before pressing the **AUTO TAPE TUNING** button. When the Auto Tape Tuning is completed, the TAPE TUNING indicator lights. After completion of Auto Tape Tuning, the tape automatically rewinds to the point where the Auto Tape Tuning began and the REC/PAUSE mode is engaged. The bias adjustment with the **BIAS ADJUST** control is possible even after this tuning.

To clear Auto Tape Tuning setting, press the **AUTO TAPE TUNING** button once again, or load any cassette tape of different type.

- * When recording on the other side of the tape, another Auto Tape Tuning is unnecessary. When recording on the same type cassette tape of a different brand, another Auto Tape Tuning is advisable for much more accurate setting of the recording characteristics.

AUTO TAPE TUNING

The Auto Tape Tuning function improves the quality of your recording, permitting critical adjustment of the deck's recording bias and sensitivity for best results with every tape you use.

With the Auto Tape Tuning function, the recording characteristics (recording bias and sensitivity) are automatically adjusted while recording and playback operations in about 20 seconds, to accurately match the characteristics of loaded tape.

For example, the recorded (output) level (A in the figure) may differ from recording (input) level (B in the figure), due to widely varying characteristics of cassette tapes between brands.

Using the Auto Tape Tuning function, these differences are effectively eliminated by adjusting the recording bias (for high frequencies) and sensitivity (for overall frequencies) according to the loaded cassette tape, making a significant contribution to overall recording quality (C in the figure).

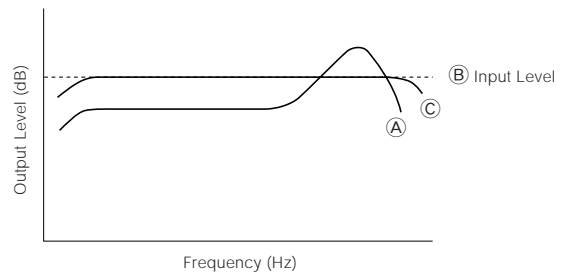

Setting the recording level (in step 5)

Play the loudest passage of the source to be recorded and watch the meter readings. Adjust the **REC LEVEL** control so that the highest peak may not exceed the optimum levels of each tape type. Normally, it is best to adjust the **BALANCE** control such that the LEFT and RIGHT meter readings are even.

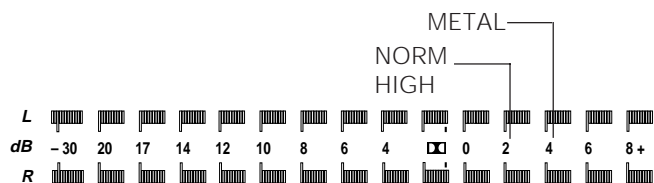

- The **Dolby** mark indicates the Dolby noise reduction system standard level and corresponds to the -2 dB segment on the meter.

Bias adjustment

The **BIAS ADJUST** control is for fine adjustment of the recording bias. Normally, it is not necessary to adjust this control since the recording bias can be automatically adjusted by the built-in Auto Tape Selector and the **AUTO TAPE TUNING** button for different tape types. However, if you feel that your recording needs further bias adjustment (to compensate for absent or distorted high frequencies), adjust this control to your liking.

When high frequencies are distorted, increase the recording bias by turning the **BIAS ADJUST** control clockwise.

When high frequencies are absent, decrease the recording bias by turning the **BIAS ADJUST** control counterclockwise.

KX-493

BIAS ADJUST

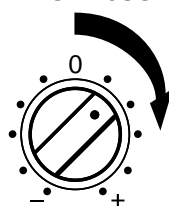

BIAS ADJUST

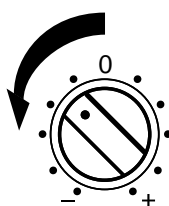

KX-393

BIAS ADJUST

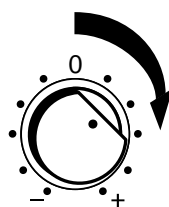

BIAS ADJUST

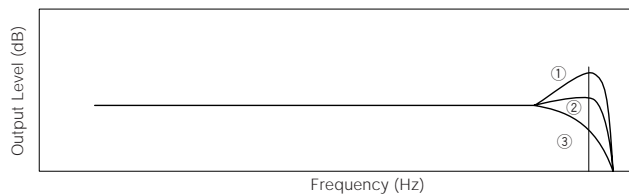
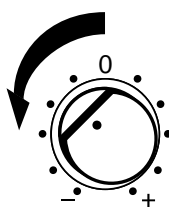

- ① Insufficient bias (High frequencies are distorted.)
- ② Optimum bias
- ③ Excessive bias (High frequencies are absent.)

Synchronized recording function

When operating this unit in combination with the YAMAHA CD Player which has **SYNCHRO** button on its remote control transmitter, CD Synchronized recording function can be utilized. This function is operated with the remote control transmitter of the CD Player. (Regarding the operation, refer to the manual of the CD Player.) **SYNCHRO** indicator of this unit lights when the **SYNCHRO** button of the remote controller is pressed.

KX-493

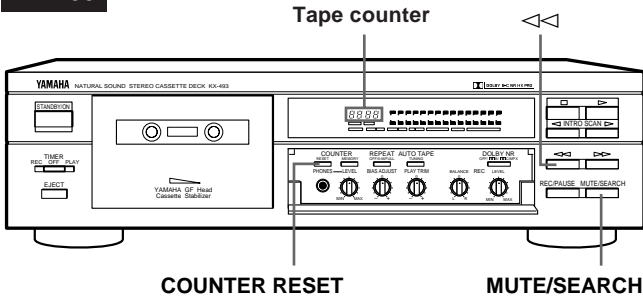

KX-393

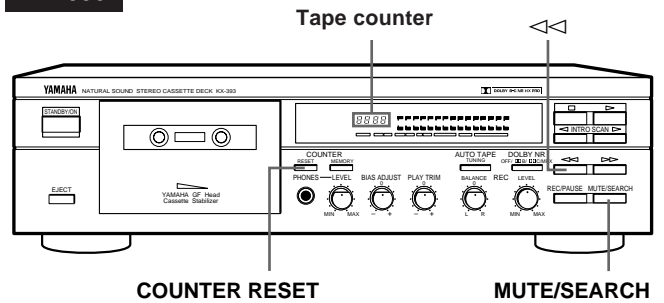

REC MUTE OPERATION - Inserting a blank space during recording

During recording

MUTE/SEARCH

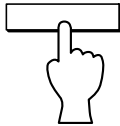

A 4-second blank interval is automatically recorded on the tape, and then the deck enters Rec/Pause mode. If a blank interval longer than 4 seconds is desired, keep pressing the button as long as you want. When the **MUTE/SEARCH** button is released, the deck enters Rec/Pause mode after making a 4-second blank interval.

0-STOP OPERATION - To return to the "0000" point

During recording

RESET

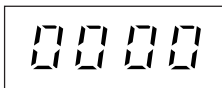

The "0000" point is memorized.

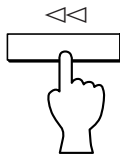

The tape will be automatically rewound to the "0000" point.

REC RETURN OPERATION - To return to the point at which the recording previously started

During recording

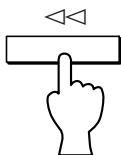

- If the << button is pressed during recording, Rec Return operation automatically rewinds the tape to the point where the >> button was pressed.

DOLBY HX PRO DYNAMIC BIAS SERVO SYSTEM

This unit incorporates the Dolby HX Pro system which automatically controls the effective bias to reduce distortion and noise, improving high frequency response during recording. Tapes recorded with this system retain the same high quality even when played back on any other cassette deck.

Dolby noise reduction and HX Pro headroom extension manufactured under license from Dolby Laboratories Licensing Corporation. HX Pro originated by Bang & Olufsen.

"DOLBY", the double-D symbol **DD** and "HX PRO" are trademarks of Dolby Laboratories Licensing Corporation.

TIMER RECORDING/PLAYBACK (**KX-493** only)

With a commercially available audio timer it is possible to make recordings and initiate playback automatically at any time.

Make sure that all power cord connections between the timer and amplifier/receiver are properly made.

For details, refer to the instructions of your audio timer. No change in any of the other connections between the deck and amplifier/receiver, etc., is necessary.

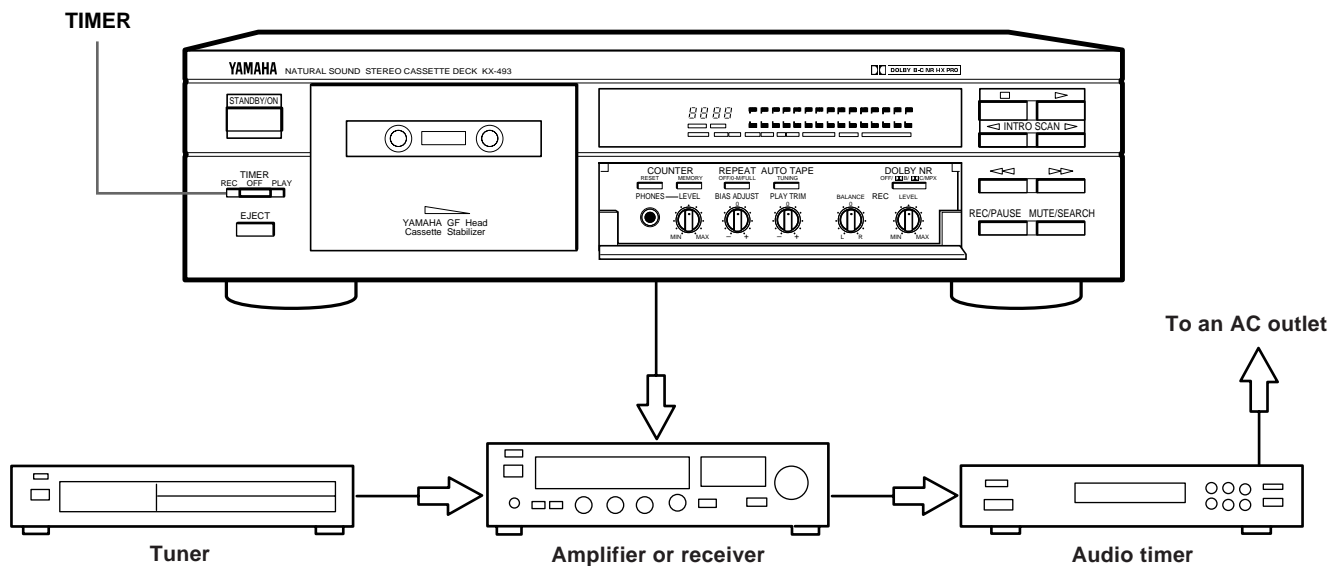

Timer recording

1. After turning on the power to each component, select the station on your tuner which you want to record and turn down the volume on your amplifier/receiver. This will have no effect on the recording signal level. Remember to set the proper recording level.
2. Set the timer to the desired recording start and stop times. It is advisable to set the timer to begin recording slightly before and end slightly after the actual broadcast receiving time to leave some room for later editing.
3. Set the **TIMER** switch to the REC position.

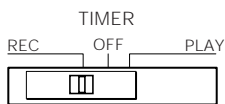

4. The timer will send power to the amplifier/receiver, tuner and deck at the preset time, turning all the components on and initiating the recording.

Timer playback

1. Turn on the amplifier/receiver and adjust the volume and tone controls.
2. Set the input mode selector of your amplifier/receiver to the cassette deck function mode.
3. Set the timer to the time you wish to start and stop playback.
4. Set the **TIMER** switch to the PLAY position.

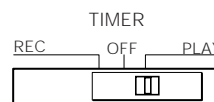

5. At the preset time, the timer will turn power on to the amplifier/receiver and cassette deck and begin playback. It will shut power off at the preset time as well ending playback.

Note: Whenever the timer recording/playback is not intended, make sure to set the **TIMER** switch to OFF position to prevent the unnecessary recording/playback.

- If the **TIMER** switch is set to REC position and the power is supplied (plugging in the power cord or automatically supplying the power after power failure, etc.), the deck automatically enters Rec mode and the contents of the cassette tape inserted in the deck will be erased.

CASSETTE TAPES

CASSETTE TAPES

There are many different types of cassette tapes available. However, they all conform to standard specifications so any brand may be used with the deck.

- Classification of Cassette Tapes by Formulation
Cassette tapes are available in four basic types depending on their formulation, or type of magnetic material and manufacturing process. These four types are commonly known as Normal (Type I/NORM), Chrome (Type II/HIGH $\langle\text{CrO}_2\rangle$), Ferrichrome (Type III/FeCr), and Metal (Type IV/METAL), and they each require specific tape deck adjustments for optimum performance.
- * YAMAHA does not recommend the use of 120 minute length cassettes since the extreme thinness of the tape makes them susceptible to mechanical and recording problems.

AUTO TAPE SELECTOR DETECTION SLOTS

The deck has a built-in Auto Tape Selector which automatically adjusts for the proper bias, level and equalization according to the tape formulation — all you have to do is load a cassette and the Auto Tape Selector does the rest.

The Auto Tape Selector determines which type of tape is loaded by sensing detector slots in the top of the tape shell.

- Early model Metal (Type IV/Metal) tape formulation cassette shells do not have the slots for Auto Tape Selector operation. As a result, early model Metal type tapes recorded on another deck will be played back with the deck at the Chrome (Type II/HIGH $\langle\text{CrO}_2\rangle$) settings. YAMAHA does not recommend using this kind of tape.
- The deck does not have the required setting for Ferrichrome (Type III/FeCr) tape, since this tape formulation is not widely used. Should you use a Ferrichrome tape, it will be recorded and played back at the Normal (Type I/NORM) settings, which will result in an unnatural high frequency emphasis. This effect may be compensated for somewhat by adjusting the BIAS ADJUST to the plus (+) direction during recording, or by using the PLAY TRIM control and/or the tone controls of your amplifier/receiver during playback.

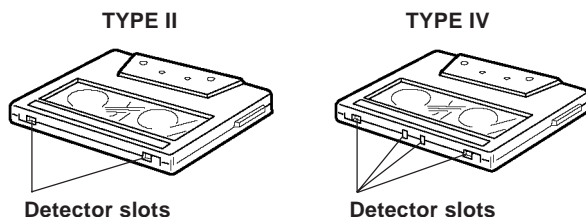

PROTECTING YOUR RECORDINGS

All cassette tapes are provided with erasure protection holes to prevent accidental erasure of recorded contents. There is a small tab covering the hole on each side of the cassette, and it should be broken off after recording the tape. Without this tab covering the hole, it is impossible to record onto that tape. Thus, you can safely protect a recording for as long as you wish without fear of accidental erasure. Should you wish to use a cassette tape protected in this way for recording, simply covering the hole with adhesive tape will permit erasure and re-recording.

- When using Chrome (Type II/HIGH $\langle\text{CrO}_2\rangle$) or Metal (Type IV/METAL) tapes, make sure you do not cover the hole intended for the Auto Tape Selector operation.

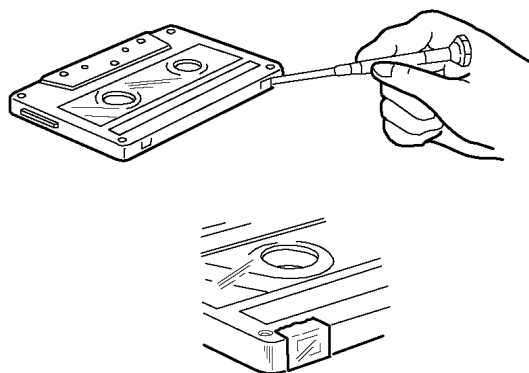

TAKING UP SLACK IN THE TAPE

As a precaution against tape entanglement and damage, remove any slack in the tape before inserting cassettes into the deck. This is accomplished by inserting a pencil, pen or similar object into one of the spools and gently winding it until all the slack is removed. You do not have to wind it too tightly.

Be careful not to touch the tape part itself. It is very delicate and touching it may damage the tape and its recorded contents.

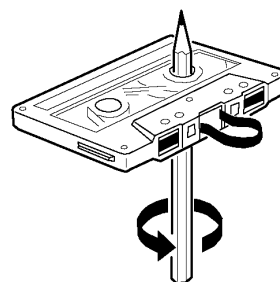

STORING CASSETTES

After putting a cassette tape back into its case, store it in a location away from exposure to direct sunlight, humidity, high temperatures, and magnetic fields (away from television sets, speakers, etc.). High temperatures and humidity will damage the tape itself, while exposure to magnetic fields may cause a loss of recorded material. Avoid touching the tape surface with your fingers, since dirt or finger oil will contaminate the deck's heads.

OPENING AND CLOSING THE SUB PANEL (KX-493 only)

To open the sub panel

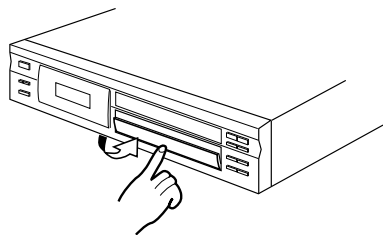

To close the sub panel

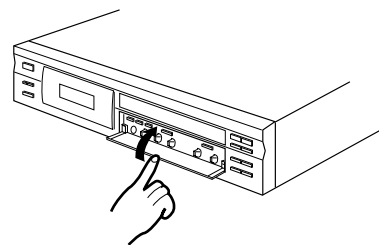

OPTIONAL REMOTE CONTROL TRANSMITTER

With the optional remote control transmitter RKX1, you can operate this unit at your listening position. For details, refer to the instruction manual supplied with the remote control transmitter.

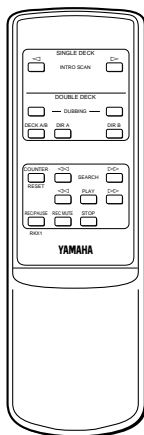

REMOTE CONTROL OPERATION RANGE

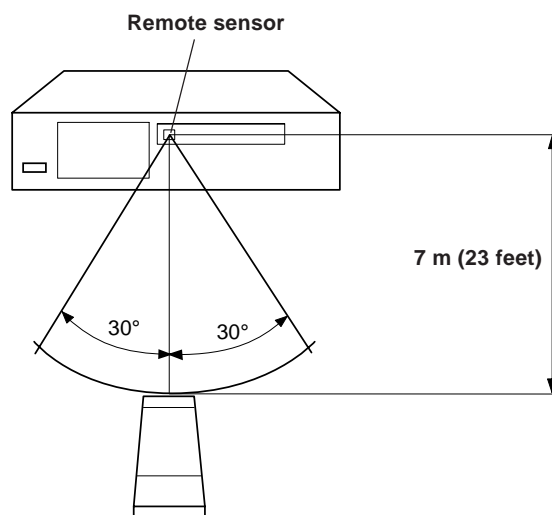

MAINTENANCE

CLEANING OF THE TAPE PATH

Continued high quality performance of your deck is dependent upon periodic cleaning of the heads, capstan, pinch roller, and all surfaces over which the tape travels. Normal use will cause an accumulation of dirt and dust on the heads, capstans, and pinch rollers. This can lead to poor sound quality, drop outs (intervals with no sound), unsteady tape speed, loss of high frequency response, etc.

Thus, clean the heads and all surfaces over which the tape travels with a commercially available cleaning cassette and fluid type cleaner.

Inside of the cassette compartment

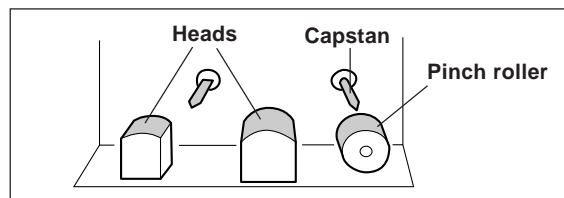

DEMAGNETIZATION

After 20-30 hours of use, enough residual magnetism will build up on the heads to cause poor high frequency reproduction. At this time you should use a commercially available head demagnetizer.

- When cleaning the tape path or demagnetizing the heads, be sure to follow carefully the instructions of the concerning materials such as cleaning fluid or head demagnetizer.

TROUBLESHOOTING

If your cassette deck fails to operate normally, check the following table. It lists common operating errors and simple measures which you can take to correct the problem. If it cannot be corrected, or the symptom is not listed, disconnect the deck's power cord and contact your authorized YAMAHA dealer or service center for help.

Fault	Cause	Cure
Tape doesn't move in recording or playback.	<ul style="list-style-type: none"> ● Power plug is not properly plugged in. ● End of tape. ● Cassette shell is warped or damaged. 	<ul style="list-style-type: none"> ● Reinsert plug properly. ● Rewind tape or flip it over. ● Do not play damaged tapes.
It happens that this unit does not work normally.	<ul style="list-style-type: none"> ● There is an influence of strong external noise (lightning, excessive static electricity, etc.) or a misoperation was performed while using this unit. 	<ul style="list-style-type: none"> ● Turn this unit power off and disconnect the AC power from the AC outlet. After about 30 seconds have passed, connect the power and try again.
REC/PAUSE button fails to function.	<ul style="list-style-type: none"> ● No cassette tape loaded. ● Protective tabs are broken off. 	<ul style="list-style-type: none"> ● Load a cassette tape. ● Change tape or cover protective hole with adhesive tape.
Sounds become faint and sometimes inaudible.	<ul style="list-style-type: none"> ● Head is dirty. ● Head is magnetized. ● Tape is damaged or of poor quality. 	<ul style="list-style-type: none"> ● Clean head. ● Demagnetize head using head demagnetizer. ● Change to a different tape.
Recorded sound is distorted.	<ul style="list-style-type: none"> ● Tape is bad (stretched or deformed, etc.). ● Cassette shell is warped. ● Recording level is too high. 	<ul style="list-style-type: none"> ● Replace with a fresh tape. ● A warped cassette shell cannot be fixed. Replace with another tape and test. ● Check input level with signal level meter and use lower rec level when recording.
Tape is playing back, but no sound is heard.	<ul style="list-style-type: none"> ● Faulty connection between deck and stereo amplifier/receiver. 	<ul style="list-style-type: none"> ● Check and secure connections.
Excessive noise.	<ul style="list-style-type: none"> ● Head is dirty. ● Head is magnetized. ● Worn out or poor quality tape. ● Connection(s) improperly made. ● Affected by external electrical noise. 	<ul style="list-style-type: none"> ● Clean head. ● Demagnetize head with head demagnetizer. ● Change to better tape. ● Check input and output connections and reinsert properly. ● Move away from electrical appliances (TV, fluorescent light, electric blanket, etc.).
Excessive wow (wavering of the sound).	<ul style="list-style-type: none"> ● Dirty capstan, pinch roller, etc., or poor tape. ● Tape is wound unevenly. 	<ul style="list-style-type: none"> ● Clean capstan and pinch roller, or change to better tape. ● Rewind tape.
Tape stops in the middle of recording or playback.	<ul style="list-style-type: none"> ● Slack tape, or tape spillage wound around capstan. 	<ul style="list-style-type: none"> ● Insert pencil in hole in cassette shell and turn to take up slack.
Fails to record.	<ul style="list-style-type: none"> ● REC LEVEL control is set to too low. ● Protective tabs are broken off. 	<ul style="list-style-type: none"> ● Adjust REC LEVEL control. ● Change tape or cover protective hole with adhesive tape.
Search does not operate.	<ul style="list-style-type: none"> ● Recorded section is too short. ● Recorded section has low-level portions. ● Conversation, etc. has been recorded. 	<ul style="list-style-type: none"> ● Blank sections must be at least 4 seconds long. ● No remedy ● No remedy
High frequencies in the playback sound are emphasized and unpleasant to listen to, and noise level (hiss) is also high.	<ul style="list-style-type: none"> ● Dolby NR-recorded tape is played back in OFF position. 	<ul style="list-style-type: none"> ● Play back in appropriate Dolby NR position.

Fault	Cause	Cure
Playback sound is muffled and high frequencies are inaudible.	<ul style="list-style-type: none"> Normally-recorded tape is played back in Dolby NR. Heads are dirty. Heads are magnetized. 	<ul style="list-style-type: none"> Playback in OFF position. Clean heads and carry out demagnetization with head demagnetizer.
When playing back tapes recorded on other decks, meter deflections are greater (smaller) than when recorded.	<ul style="list-style-type: none"> Basic levels are different for different cassette decks. 	<ul style="list-style-type: none"> This is not a fault.
(KX-493 only) Recordings cannot be made with TIMER REC (deck only plays back).	<ul style="list-style-type: none"> Protective tabs on cassette have been broken off. 	<ul style="list-style-type: none"> Replace cassette tape, or cover tab holes with tape, etc.
The remote control transmitter cannot be operated.	<ul style="list-style-type: none"> The batteries are exhausted. The remote control transmitter is operated from an incorrect distance or angle. The remote control sensor is lighted strongly. 	<ul style="list-style-type: none"> Replace batteries. Operate it from less than 7 meters (about 23 ft.) and 30°. Place the unit away from the strong light.

SPECIFICATIONS

Track Configuration 4 track, 2 channel stereo

Motor

KX-493 DC servo motor (capstan)
Flat torque DC motor (reel)

KX-393 DC servo motor

Head Recording/playback: hard permalloy
Erase: double-gap Ferrite head

Rapid Transport

KX-493 90 sec. (C-60)

KX-393 100 sec. (C-60)

Wow and Flutter

<KX-493>

WRMS 0.05%

W.Peak ±0.08%

<KX-393>

WRMS 0.07%

W.Peak ±0.12%

Signal-to-Noise Ratio

<KX-493>

Dolby NR off 60 dB

Dolby B NR on 68 dB

Dolby C NR on 76 dB

<KX-393>

Dolby NR off 58 dB

Dolby B NR on 66 dB

Dolby C NR on 74 dB

Frequency Response

<KX-493>

Normal tape (-20 dB) 20 ~ 17,000 Hz ±3 dB

CrO2 tape (-20 dB) 20 ~ 18,000 Hz ±3 dB

Metal tape (-20 dB) 20 ~ 20,000 Hz ±3 dB

<KX-393>

Normal tape (-20 dB) 20 ~ 16,000 Hz ±3 dB

CrO2 tape (-20 dB) 20 ~ 17,000 Hz ±3 dB

Metal tape (-20 dB) 20 ~ 19,000 Hz ±3 dB

Harmonic Distortion 0.8%

Input Sensitivity/Impedance

Line 100 mV/50 k-ohms

Output Level

Line 570 mV/1.0 k-ohms

Phones 1.5 mW/8 ohms

Channel Separation (1 kHz) 40 dB

Cross Talk (125 Hz) 55 dB

GENERAL

Power Supplies

U.S.A. and Canada model 120 V, 60 Hz

Europe and U.K. model 230 V, 50 Hz

Australia model 240 V, 50 Hz

General model 110/120/220/240 V, 50/60 Hz

Power Consumption 16 W (KX-493)

12 W (KX-393)

5 W (Standby)

Dimensions (W x H x D)

KX-493 435 x 125.5 x 278.5 mm
(Approx. 17-1/8" x 4-15/16" x 11")

KX-393 435 x 125.5 x 283 mm
(Approx. 17-1/8" x 4-15/16" x 11-1/8")

Weight

KX-493 4.5 kg (9 lbs. 15 oz.)

KX-393 4.4 kg (9 lbs. 11 oz.)

Accessories

Output/input cord 1 pair

* Specifications subject to change without notice.

Problème	Cause	Remède
Le son de lecture est étouffé et les hautes fréquences sont inaudibles.	<ul style="list-style-type: none"> ● Une bande enregistrée normalement est lue avec Dolby NR. ● Les têtes sont sales. ● Les têtes sont magnétisées. 	<ul style="list-style-type: none"> ● Ne pas utiliser le réducteur Dolby NR. ● Nettoyer les têtes et effectuer la démagnétisation avec un démagnétiseur de tête.
Lors de la lecture de bandes enregistrées sur d'autres platines, les déflexions du compteur sont plus grandes (plus petites) qu'à l'enregistrement.	<ul style="list-style-type: none"> ● Les niveaux de base sont différents pour diverses platines. 	<ul style="list-style-type: none"> ● Ceci n'est pas un défaut.
(KX-493 seulement) Les enregistrements ne sont pas possibles avec TIMER REC (la platine ne fait que lire).	<ul style="list-style-type: none"> ● Les languettes de protection sur la cassette ont été brisées. 	<ul style="list-style-type: none"> ● Remplacer la cassette ou couvrir les trous des languettes avec une bande adhésive, etc.
La télécommande ne fonctionne pas.	<ul style="list-style-type: none"> ● La pile est déchargée. ● La télécommande est actionnée d'une distance ou sous un angle incorrects. ● Le détecteur de la télécommande est fortement éclairé. 	<ul style="list-style-type: none"> ● Remplacer la pile. ● La faire fonctionner à moins de 7 mètres et sur 30°. ● Placer l'appareil à l'abri de lumières fortes.

CARACTERISTIQUES TECHNIQUES

Configuration des pistes 4 pistes, 2 canaux stéréo
Moteur

KX-493 Moteur asservi CC (cabestan)
Moteur CC à couple uniforme (bobine)

KX-393 Moteur asservi CC

Têtes Enregistrement/lecture: permalloy dur
Tête d'effacement ferrite à double entrefer

Transport rapide

KX-493 90 secondes (C-60)

KX-393 100 secondes (C-60)

Pleurage et scintillement

<KX-493>

Valeur efficace, pondérée 0,05 %

Valeur crête, pondérée ±0,08 %

<KX-393>

Valeur efficace, pondérée 0,07 %

Valeur crête, pondérée ±0,12 %

Rapport signal/bruit

<KX-493>

Dolby NR à l'arrêt 60 dB

Dolby B NR en marche 68 dB

Dolby C NR en marche 76 dB

<KX-393>

Dolby NR à l'arrêt 58 dB

Dolby B NR en marche 66 dB

Dolby C NR en marche 74 dB

Réponse en fréquence

<KX-493>

Bande normale (-20 dB) 20 ~ 17.000 Hz ±3 dB

Bande CrO₂ (-20 dB) 20 ~ 18.000 Hz ±3 dB

Bande métal (-20 dB) 20 ~ 20.000 Hz ±3 dB

<KX-393>

Bande normale (-20 dB) 20 ~ 16.000 Hz ±3 dB

Bande CrO₂ (-20 dB) 20 ~ 17.000 Hz ±3 dB

Bande métal (-20 dB) 20 ~ 19.000 Hz ±3 dB

Distorsion harmonique 0,8%

Sensibilité d'entrée/impédance

Ligne 100 mV/50 kohms

Niveau de sortie

Ligne 570 mV/1,0 kohms

Casque 1,5 mW/8 ohms

Séparation des canaux (1 kHz) 40 dB

Diaphonie (125 Hz) 55 dB

GENERALES

Alimentation

Modèle pour les Etats-Unis

et le Canada 120 V, 60 Hz

Modèle pour l'Europe et

le Royaume-Uni 230 V, 50 Hz

Modèle pour l'Australie 240 V, 50 Hz

Modèle universel 110/120/220/240 V, 50/60 Hz

Consommation 16 W (KX-493)

12 W (KX-393)

5 W (Veille)

Dimensions (L x H x P)

KX-493 435 x 125.5 x 278.5 mm

KX-393 435 x 125.5 x 283 mm

Poids

KX-493 4,5 kg

KX-393 4,4 kg

Accessoires

Câble d'entrée/sortie 1 paire

* Les caractéristiques techniques sont sujettes à des changements sans préavis.

YAMAHA ELECTRONICS CORPORATION, USA 6660 ORANGETHORPE AVE., BUENA PARK, CALIF. 90620, U.S.A.

YAMAHA CANADA MUSIC LTD. 135 MILNER AVE., SCARBOROUGH, ONTARIO M1S 3R1, CANADA

YAMAHA ELECTRONIK EUROPA G.m.b.H. SIEMENSSTR. 22-34, 25462 RELLINGEN, BEI HAMBURG, F.R. OF GERMANY

YAMAHA ELECTRONIQUE FRANCE S.A. RUE AMBROISE CROIZAT BP70 CROISSY-BEAUBOURG 77312 MARNE-LA-VALLÉE CEDEX02, FRANCE

YAMAHA ELECTRONICS (UK) LTD. YAMAHA HOUSE, 200 RICKMANSWORTH ROAD WATFORD, HERTS WD1 7JS, ENGLAND

YAMAHA SCANDINAVIA A.B. J A WETTERGRENS GATA 1, BOX 30053, 400 43 VASTRA FRÖLUNDA, SWEDEN

YAMAHA MUSIC AUSTRALIA PTY, LTD. 17-33 MARKET ST., SOUTH MELBOURNE, 3205 VIC., AUSTRALIA

YAMAHA CORPORATION

Printed in Malaysia

VZ 77980