

YAMAHA

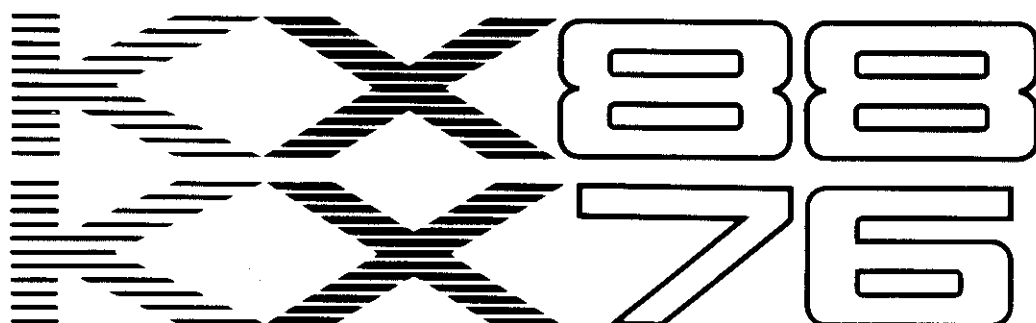

**MIDI MASTER KEYBOARD
CLAVIER PRINCIPAL MIDI
MIDI MASTER KEYBOARD**

**OWNER'S MANUAL
MANUEL DE L'ACHETEUR
BEDIENUNGSANLEITUNG**

ABOUT THIS MANUAL

We would like to take this opportunity to thank you for purchasing the Yamaha KX88/76 MIDI Master keyboard. The KX88/76 puts you in complete control of all MIDI devices, both those presently on the market and those yet to come. In order to take full advantage of the KX88/76, please read this manual carefully.

This manual is divided into three chapters.

1. A guided tour of the KX88/76.
 2. A detailed, systematic explanation of the KX88/76.
 3. Charts and tables. Reference material.
- The best way to understand something like the KX88/76 is to use it, so rather than tell you everything about the KX88/76, first we're going to show you how to play it, and then begin explaining about it's incredibly wide possibilities. So, we recommend that you go through this manual in order and try all the examples.

CONTENTS

ABOUT THIS MANUAL	1
DESCRIPTION	2
PRECAUTIONS	2
FEATURES	3
CONNECTIONS	5
CHAPTER 1: LET'S PLAY THE KX88/76	6
IMPORTANT NOTE	6
THREE MODES	7
PLAY MODE	7
CHAPTER 2: FUNCTIONS OF THE KX88/76	9
SUMMARY OF THE KX88/76	9
FUNCTIONS OF THE KX88/76	9
■ PLAY MODE	9
■ CA MODE	9
■ INTERNAL FUNCTIONS	10
■ PA MODE	11
SPECIAL FUNCTIONS	12
MIDI BULK DATA DUMP	12
PRECAUTIONS WHEN USING THE KX88/76 WITH THE DX7	13
BEFORE YOU PANIC	13
CHAPTER 3: SETTING UP THE KX88/76	14
CA MODE	14
■ OTHER FUNCTIONS IN CA MODE	17
PA MODE	18
■ FUTURE USES OF PA MODE	18
■ CONTROL CHANGE	18
■ PARAMETER CHANGE	19
■ UNIVERSAL PARAMETER	21
■ OTHER PA MODE FUNCTIONS	21
VOICE SELECTION IN 8 BANK MODE	21
KX88/76 BLOCK DIAGRAM	22
SPECIFICATIONS	23
CHAPTER 4: FOR REFERENCE	24
■ CONTROLLER CODE PRESET TABLE	24
MIDI OUTPUT	24
MIDI INPUT	25
OTHER SPECIFICATIONS	25
■ BINARY, DECIMAL AND HEXADECIMAL CONVERSION	26
CHANNEL VOICE MESSAGE	27
DX SERIES PARAMETER CHANGE	29
KX88/76 CONTROLLER ASSIGN TABLE	33
MIDI IMPLEMENTATION CHART	34
FCC CERTIFICATION	36

DESCRIPTION

The Yamaha KX88 is an 88 key, weighted action MIDI keyboard, the Yamaha KX76 is a 76 key light touch keyboard and control center for all MIDI equipped instruments and devices. It is the first completely programmable and assignable MIDI keyboard. Each of the controllers (pitch and modulation wheels, after touch, breath controller, 2 foot controllers, 2 foot switches, 4 front panel sliders and 7 front panel buttons) may be programmed to send any type of MIDI information.

Also, the keyboard may be used in one of three modes:

Single: All key on/off signals are sent on one MIDI channel.

Dual: All key on/off signals are sent simultaneously on two MIDI channels.

Split: The keyboard may be split at any selected point, and upper and lower sections sent on different MIDI channels.

The keyboard may be transposed up or down in half-steps, to a maximum of ± 2 octaves. In split mode, the upper and lower sections may be transposed independently. All settings (keyboard mode, MIDI channel, transpose and controller assignment) may be stored in one of 16 memory banks, and recalled by any specified controller.

PRECAUTIONS

LOCATION

Avoid placing the KX88/76 in direct sunlight or close to a source of heat. Also, avoid locations in which the instrument is likely to be subjected to vibration, excessive dust, cold or moisture.

HANDLING

Avoid applying excessive force to the slide knobs, dropping or rough handling. While the internal circuitry is of reliable, integrated circuit design, the KX88/76 is nonetheless a fine instrument that should be treated with care.

POWER CORD

Always grip the plug directly when removing it from an AC receptacle. Removing the plug from the AC receptacle by pulling the cord can result in damage to the cord, and possibly a short circuit. It is also a good idea to disconnect the KX88/76 from the AC receptacle if you don't plan to use the instrument for an extended period of time.

CLEANING

Use only a mild detergent on a cloth, and dry with a soft cloth. Never use solvents (such as benzine or thinner) since they can melt or discolor the instrument.

ELECTRICAL STORMS (LIGHTNING)

Computer circuitry, including that in the KX88/76, is sensitive to voltage spikes. For this reason, the DX7 should be turned off and unplugged from the AC receptacle in the event of an electrical storm. This precaution will avoid the chance that a high voltage spike caused by lightning will damage the instrument.

ELECTROMAGNETIC FIELDS

Computer circuitry is also sensitive to electromagnetic radiation. Television sets, radio receivers, transmitters, transceivers, wireless microphone and intercom systems are all potential sources of such radiation. The KX88/76 should not be placed too close to such devices.

FEATURES

Throughout this manual, we will use illustrations of the KX88.

The only difference between the KX88 and the KX76 is the keyboard and the position of the Bank LEDs.

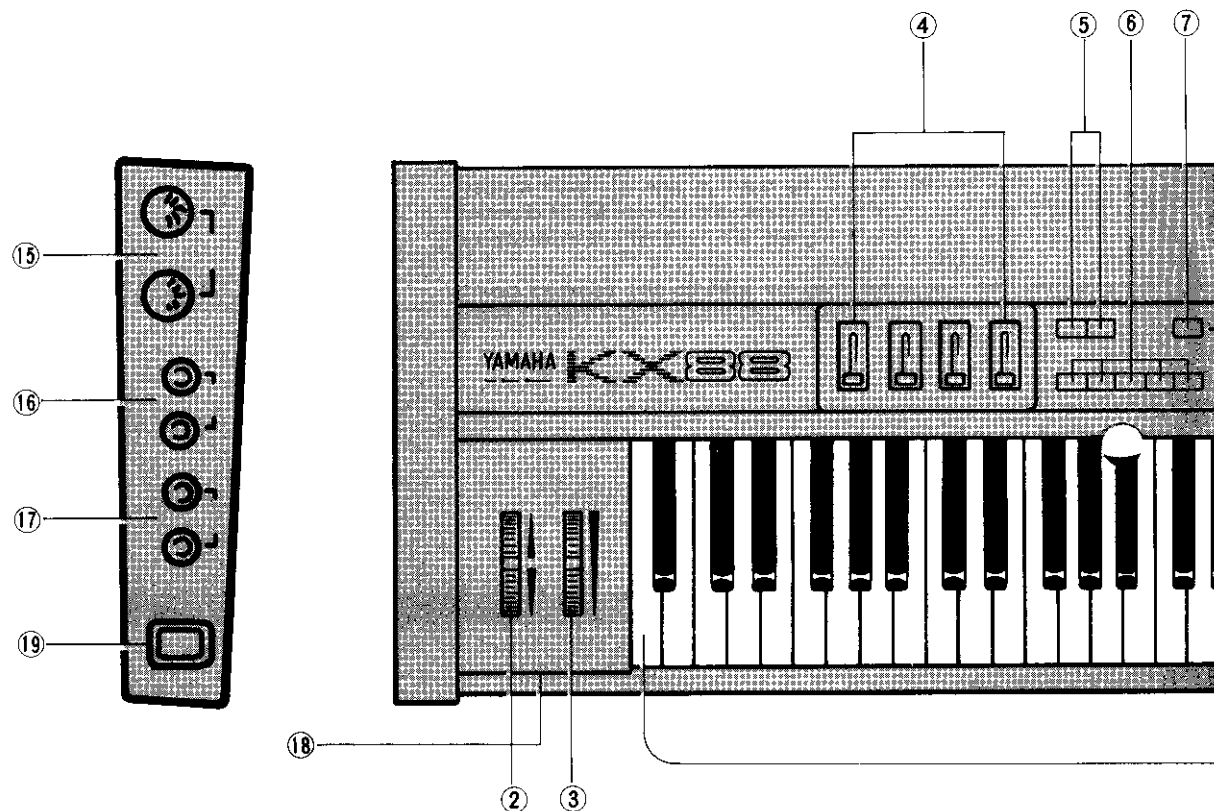

1. KEYBOARD

An 88 key weighted action keyboard (the KX76 has a 76 key light touch keyboard) with initial and after touch sensitivity. It functions in three modes: SINGLE, DUAL and SPLIT.

2. WHEEL 1

3. WHEEL 2

Wheel 1 is a center-return pitch-bend type, and Wheel 2 is a modulation wheel type. These wheels perform the functions assigned to them.

4. CS 1-4

Continuous Sliders 1-4 perform the functions assigned to them.

5. TS1, 2

Toggle Switches 1 and 2 each perform 2 functions; one when the LED is on, and one when off. Each time TS1 or 2 is pressed, the LED alternates on/off, and it will perform the function assigned to it.

6. MS1-5

Momentary Switches 1-5 perform the function assigned to them each time they are pressed.

7. MODE SWITCH

This switch selects between the 3 operation modes. Each time the MODE switch is pressed, it will alternate between PLAY and CA mode. While in CA mode, if you press MODE for more than 1 second, it will enter PA mode.

8. MODE INDICATOR LED

In PLAY mode, it indicates one of the three keyboard modes: SINGLE, DUAL or SPLIT.

9. ASSIGN LED

In CA mode, the upper LED (CONTROLLER) will be lit, and in PA mode, the lower LED (PARAMETER) will be lit.

10. UPPER READOUT, LOWER READOUT

A. Upper Readout

Play Mode — The upper readout displays the voice program number, 1-32 (or 1-128 in 8 bank mode), for bank A.

CA Mode — When CA mode is first entered, [CA] will be displayed in the readout. The selected controller, bank A MIDI channel or bank A transpose point will then be displayed, depending on the chosen function.

PA Mode — When PA mode is first entered, the upper readout will display [PA]. Data corresponding to the chosen function will then be displayed.

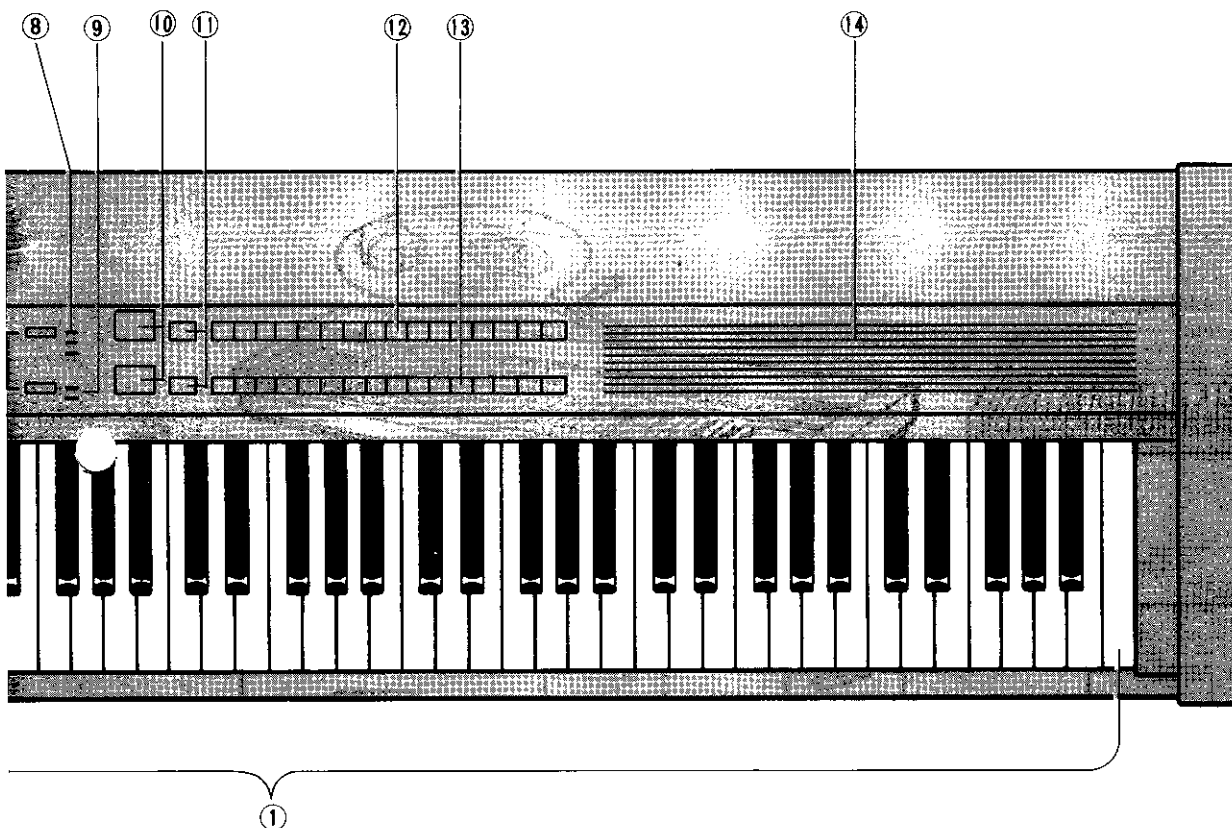

B. Lower Readout

Play Mode — The lower readout displays the voice program number, 1-32 (or 1-128 in 8 bank mode), for bank B.

CA Mode — The controller code, bank B MIDI channel or bank B transpose point is displayed, depending on the chosen function.

PA Mode — Data is displayed in the lower readout.

11. BANK SWITCH A, B

These switches choose whether the program select switches select voice programs 1-16 or 17-32 (Or in 8 BANK mode, to select banks 1-8). When the bank LED is off, the program select switches select 1-16; when on, 17-32. In CA mode, they enable or disable assignments to each bank.

12. BANK A PROGRAM SELECT SWITCHES

In PLAY mode, these select the voice program number of the MIDI tone generator units connected to the KX88/76. In 2 bank mode, voice programs 1-32 can be selected. In 8 bank mode, 1-128. In CA mode, they access the functions printed above the switches, and in PA mode, the functions printed below the switches.

13. BANK B PROGRAM SELECT SWITCHES

In PLAY mode, these select voice program numbers just like the Bank A Program Select Switches.

In CA mode, they are used to assign controller codes to controllers.

In PA mode, they are used to enter data.

14. CONTROLLER CODE PRESET TABLE

The functions for controller codes 00-3F have been permanently set, and are listed here.

15. MIDI IN, OUT JACKS

Connect a MIDI tone generator to the OUT jack, and a remote keyboard such as the KX5 to the IN jack.

16. FOOTSWITCH JACKS

Connect footswitches (such as the FC4 or FC5) to this jack. They will perform the function assigned to them.

17. FOOT CONTROLLER JACKS

Connect foot controllers (FC7) to this jack. They will perform the functions assigned to them.

18. BREATH CONTROLLER JACK

Connect a Yamaha BC1 to this jack. It will perform the function assigned to it.

19. POWER SWITCH

This turns the power on or off.

CONNECTIONS

The KX88/76 will not produce sound by itself. Please connect it with a MIDI cable to a MIDI tone generator such as the TX816, or to a MIDI synthesizer such as the DX7. You will need at least one MIDI tone generator or synthesizer, and to take advantage of the split and dual modes, two or more are necessary. To make full use of the KX88/76's possibilities, we suggest that you connect the optional foot-switches and foot controllers.

NOTE: Use only the new Yamaha FC7. The FC3A will not function with the KX88/76.

NOTE: For DX users; Set SYS INFO AVAIL, so that the DX will accept parameter change messages.

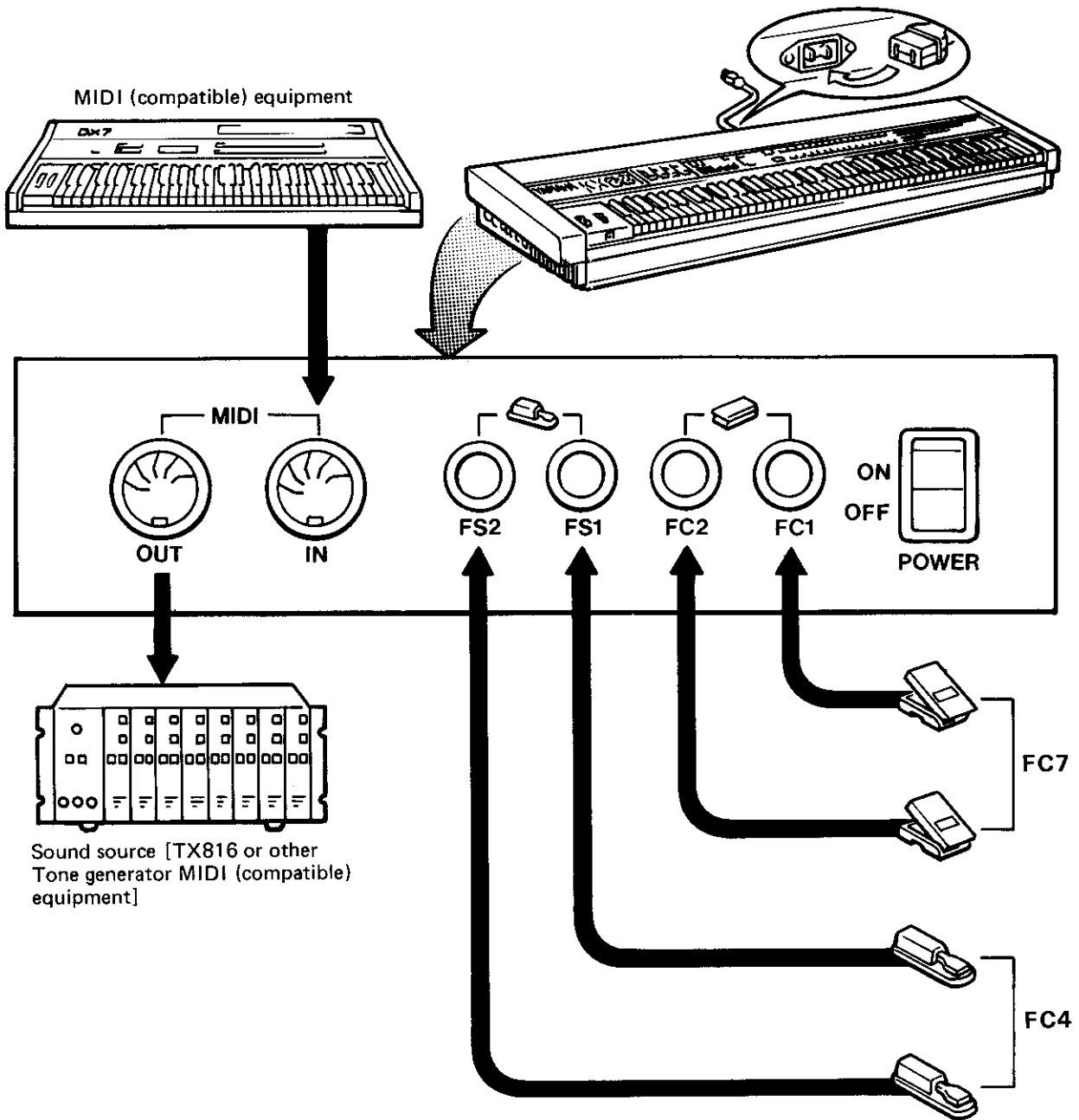

CHAPTER 1: LET'S PLAY THE KX88/76

IMPORTANT NOTE

This part of the manual is a step-by-step introduction to the KX88/76. It assumes that the KX88/76 is still as it was pre-set at the factory (ie. the same standard setting in all memory banks). If not, please initialize the memory by turning the power on while holding down the bank A and bank B switches. Doing this will set all code memories 1-16 to the same initial setting on below.

If you or someone else has already stored settings in the KX88/76, and you don't want to erase everything, select a Code Memory that you know has the original settings. (See page 10 for selecting a code memory.)

■ INITIALIZE MEMORY

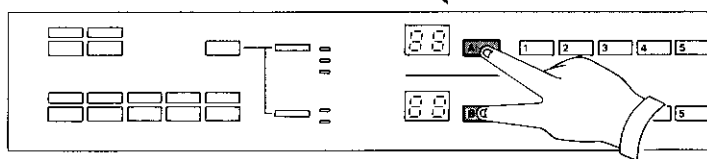
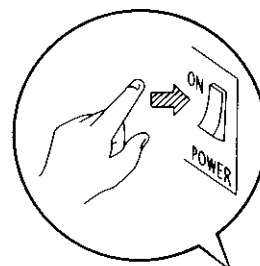

- BANK A MIDI CH1
- BANK B MIDI CH2
- SPLIT POINT C3
- BANK 2 BANK
- TRANSPOSE BANK A = C3
BANK B = C3

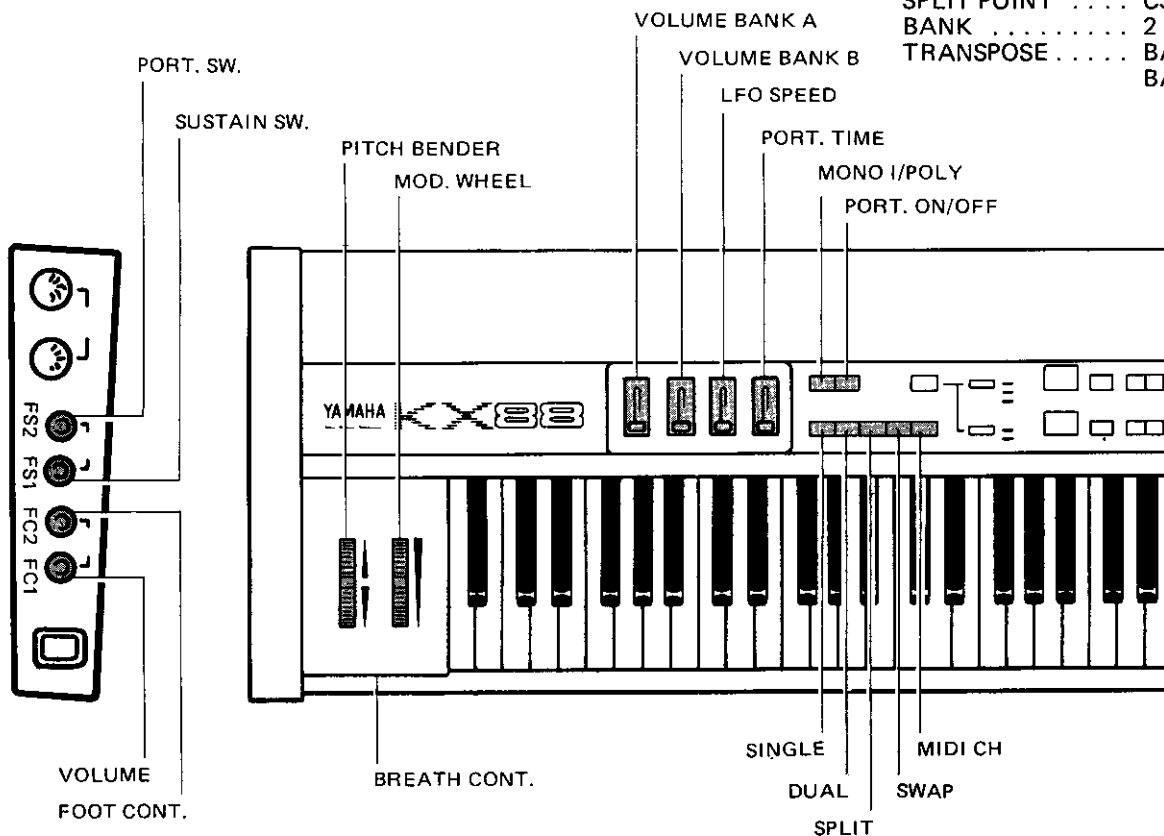

Check that all connections are correctly made as shown on page 5, and that the MIDI reception channel of the tone generator or synthesizer is set to 1 or 2. If you have two or more tone generators, set one to receive MIDI channel 1, and the other to receive MIDI channel 2. Turn the KX88/76 power switch ON. Now try playing a note on the KX88/76. The tone generator should make sound. (If there is no

sound, recheck the connections and make sure that the volume of the mixer or amp is up.) Whatever note you play, both tone generators should sound. (If this is not the case, check the Mode Indicator LED's to make sure the KX88/76 is in DUAL mode. If it isn't already in DUAL mode, press MS2. DUAL Key Assign sends each note on both MIDI channels.)

THREE MODES

The KX88/76 has three basic modes, and the selector switches have different functions in these different modes. Change modes by pressing the MODE switch. Pressing the MODE switch will take you back and forth between PLAY and CA modes. If you hold the MODE switch down for about 1 second while in CA mode, you will enter PA mode. Pressing MODE again will return you to PLAY mode.

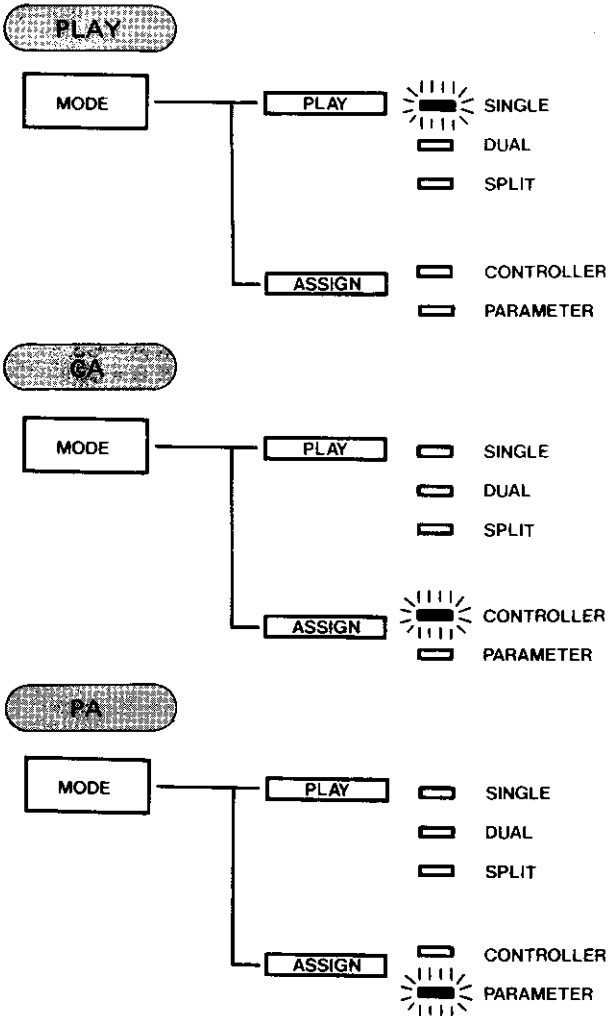

PLAY MODE

This is the mode in which you will normally play the KX88/76. One of the 3 play mode indicators will be on, and the 2 readouts will show the voice program for MIDI banks A and B.

The KX88/76 sends MIDI signals on two independent banks. (As set up at the factory, these will be MIDI channels 1 and 2.) Notice that the PLAY mode LED is indicating DUAL. This means that the whole keyboard is sending the same MIDI signals on both MIDI banks A and B.

SELECTING VOICE PROGRAMS

In PLAY mode, the two readouts will show the voice numbers for each MIDI bank. Select voices using the Bank switch and program select switches 1-16. To select voices 17-32, press the Bank switch. The Bank LED will light, and switches 1-16 will now select voices 17-32. To go back to 1-16, press the Bank switch again. In this way, you can select voices independently for MIDI banks A and B.

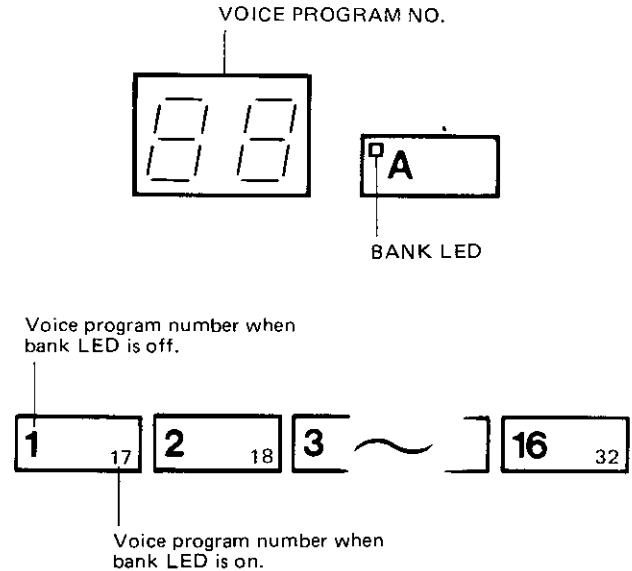

NOTE: The Yamaha DX7 and TX816 voice program memories are 1-32. However, some MIDI synthesizers and tone generator units may have up to 128 voice program memories. The KX88/76 may be set to 8 BANK mode to select voice programs 1-128. See p. 21.

ASSIGNABLE CONTROLLERS

Each of the KX88/76's controllers (Wheels 1 and 2, Breath Controller, After Touch, 4 Continuous Sliders, 5 Momentary Switches, 2 Toggle Switches, 2 Foot Controllers and 2 Foot Switches) may be assigned to perform any function you want. For example, you may have a foot controller controlling pitch-bend, and a footswitch switching between mono/poly, or switching MIDI channels. Also, these functions may be assigned to affect MIDI banks A and/or B. Your imagination is the only limit.

FACTORY PRESET CONTROLLER ASSIGNMENTS

For now, however, let's learn to use the functions that were assigned to the various controllers at the factory. (For a complete list of how the KX88/76 is preset, see page 6.)

● **SINGLE, DUAL AND SPLIT keyboard modes**

First, press MS1. (This switch has been assigned to SINGLE, from now on abbreviated to MS1 = SINGLE.) The keyboard is now in SINGLE mode. Notice the LED is now indicating SINGLE. This means that only one MIDI bank is active. If you play the KX88/76 keyboard, sound will come from only one tone generator module. Notice that only one of the readouts is lit. This indicates which MIDI bank, A or B, is being sent. To switch banks, press a program select or bank switch in the other bank. If you press the bank switch of the bank that is not being sent, that bank will now become active, with the same voice program number it had before. If you press a program select switch in the bank that is not being sent, that bank will become active, and the voice program will change to the number you have just pressed.

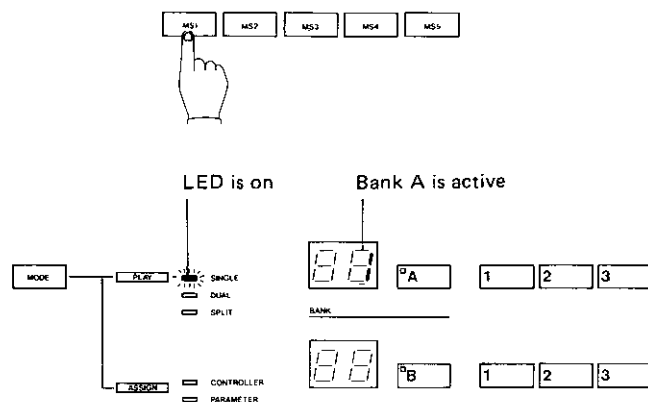

If you press MS2, you will return to DUAL mode. (MS2 has been preset to DUAL, ie. MS2 = DUAL) When you play the keyboard, both tone generators will sound, since both MIDI banks are active.

The third keyboard mode is the SPLIT mode. Press MS3. (MS3 = SPLIT) The LED will indicate SPLIT. In SPLIT mode, notes played on or below the split point will be sent on MIDI bank A, and notes played above the split point will be sent on MIDI bank B. If you press MS3 again while you are in SPLIT mode, the upper readout will show **SP** and the lower readout will show the current split point **C3**. Touch the keyboard where you want the new split point to be, and the new split point will be displayed. A decimal point indicates a sharp. (#)

● **SWAP Press MS4. (MS4 = SWAP)**

This will interchange MIDI banks A and B. Notice that the voice program numbers in the readout have traded places. Now, MIDI bank A is channel 2, and B is channel 1. If you SWAP while in SPLIT mode, the sound that you were playing on the lower part of the keyboard will interchange with the sound you were playing in the upper part.

● **MIDI CHANNEL Press MS5. (MS5 = MIDI CH)**

The readouts will show the MIDI channel number for banks A and B. (Later, we will learn how to change the channels.)

● **MONO/POLY Press TS1. (TS1 = MONO/POLY)**

The TS1 LED indicator lights, and the sound generator is now in MONO mode and will sound only the last note you play. The TS1 and TS2 Toggle switches are of a different type than the other front panel switches we have used so far. The TS1 and 2 each have two functions, one when they are pressed ON and one when they are pressed OFF. In this case, the two assignments are TS1 = Mono, Poly.

■ **PORTAMENTO ON/OFF, PORTAMENTO TIME, LFO SPEED**

Now press the other toggle switch, TS2. (TS2 = Portamento ON, Portamento OFF) When the TS2 LED is on, portamento will apply to the keyboard. (Again, all these settings can be applied to MIDI channels A and/or B, as we will explain later on p. 14.) If the portamento time is too short, you will not be able to hear it. So, adjust the portamento time using CS4 (CS4 = portamento time). Move the slider up to increase the portamento time and down to decrease the portamento time.

CS3 = LFO speed. Move it up and down to change the LFO speed.

NOTE: LFO speed is a voice parameter, and the KX88/76 is sending System Exclusive messages (Yamaha ID number) to change them. If you are using other companies' tone generator units, you will have to change these parameters by assigning a Universal Parameter. (see page 21.)

CS1 and CS2 have been assigned to VOLUME for banks A and B. Move them and notice how the volume of each tone generator changes.

● **Let's try the other controllers.**

W1 = Pitch Bender, W2 = Mod Wheel, After Touch = After Touch, Breath Controller = Breath Controller, FC1 = Volume, FC2 = Foot Controller, FS1 = Sustain switch, and FS2 = Portamento switch. All of these will affect the MIDI tone generator or synthesizer in the normal way. For example, if the DX7 function memory is set so that Foot Controller Range is 99 and Foot Pitch is ON, then using the FC2 connected to the KX88/76 will change the Pitch Modulation of the DX7.

We have now finished our explanation of the way the KX88/76 has been set up at the factory. Before you go on to the next chapter of this manual, spend some time becoming familiar with the functions we have explained.

CHAPTER 2: FUNCTION OF THE KX88/76

SUMMARY OF THE KX88/76

■ OPERATION MODES

The KX88/76 has three modes of operation: PLAY mode, CA mode, and PA mode.

You will normally play the KX88/76 in PLAY mode. When you operate the various controllers while in this mode, the MIDI data that has been assigned to the controllers will be sent.

In CA mode, you may assign functions (controller codes 00-FF) to the various controllers.

In PA mode, you may define controller codes 40-FF to be any desired MIDI information. Controller codes 00-3F have been preset at the factory and cannot be changed.

Pressing MODE will take you back and forth between PLAY and CA modes. To enter PA mode, press MODE for about 1 second while in CA mode. Pressing MODE again will take you back to PLAY mode.

■ MIDI CHANNEL

The KX88/76 sends MIDI channel messages on two channels simultaneously. We will call these MIDI BANK A and B. The channel number for each bank may be set independently.

FUNCTIONS OF THE KX88/76

■ PLAY MODE

- ① When Wheel 1-2, Breath Controller, After touch, CS1-4, Foot Controller 1-2, MS1-5, and Foot Switch 1-2 are operated, MIDI status and data will be sent according to the controller code that has been assigned to that controller.
- ② TS1-2
These are each assigned two functions, which are alternated each time they are pressed. The indicator LED for each switch shows which function is next.
- ③ Program Select Switches A 1-16, B 1-16
Banks A and B send MIDI program select messages on independent channels, and you can select voice programs independently for each bank, using the bank switches and program select switches. In 2 bank mode you can select voice programs 1-32, and in 8 bank mode, voice programs 1-128. (See page 21)
- ④ Keyboard Modes.
The KX88/76 keyboard sends MIDI key on/off information in three modes.
SINGLE – Key on/off information will be sent on either bank A or B. Select bank A or B by pressing a bank switch or program select switch of that bank.
DUAL – Key on/off information from the entire keyboard will be sent on both banks A and B.
SPLIT – Keys lower than (or equal to) the selected split point will send key on/off information on MIDI bank A, and keys above the split point will send key on/off information on MIDI bank B.

■ CA MODE

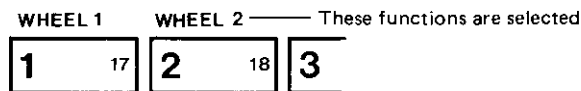

- ① In CA mode, the program select switches perform the functions printed above them. Use the bank A program select switches 1-10 to select controllers Wheel 1-Foot controller 2. The bank switch LEDs indicate which bank (A, B or both) this controller is active for. You may enable/disable each bank by pressing its bank switch. The upper readout will show which controller you have selected. (see below)

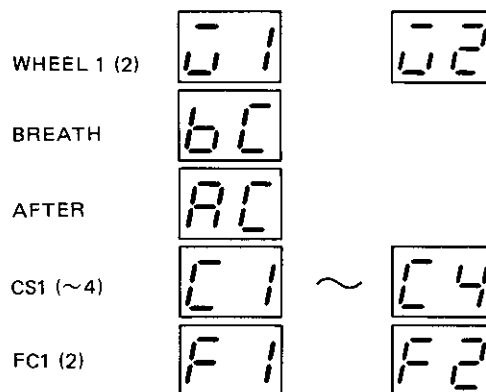

The lower readout will show the current controller code assigned to that controller. When you enter a new controller code (using bank B program select switches 1-16), it will be displayed in the lower readout and the controller assignment will change to the controller code you have just entered.

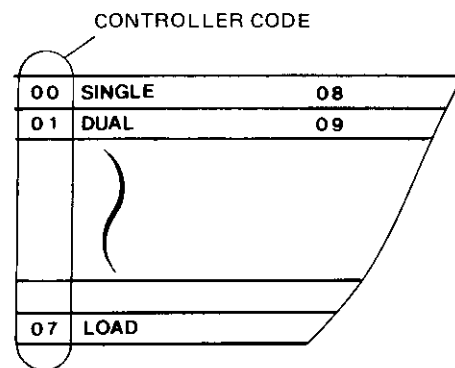
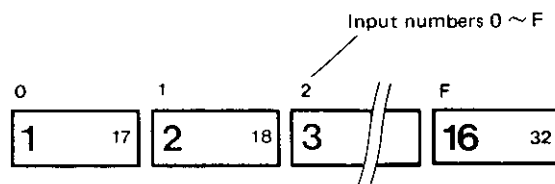

② TS1, 2

These switches each have two functions, so you must assign two controller codes to them.

In PLAY mode, if TS is pressed while the LED is off, the first function will be sent. If it is pressed when the LED is on, the second function will be sent. When you press TS1 or 2 in CA mode, the upper readout will show T1 or T2 for about one second. Then, the upper and lower readouts will show the first and second controller codes currently assigned to that switch. Enter the new controller codes using bank B program select switches 1-16 (0-F).

③ MS1-5, FS1, 2

Select these controllers by pressing the controller itself. The upper readout will indicate the selected controller. Enter the new controller code using the bank B program select switches.

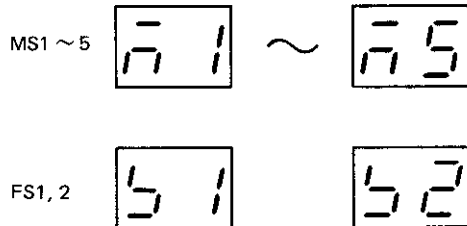

④ MIDI CH MIDI CH

11 27

The MIDI channels of banks A and B will be displayed. Select the bank you want to change by pressing bank switch A or B, and select the new channel with bank B program select switches 1-16.

⑤ TRANSPOSE TRANSPOSE

12 28

You may transpose banks A and B independently. The current transpose point for banks A and B will be shown in the readouts. Select the bank you want to transpose by pressing bank switch A or B, and press a key at the desired transpose point. (A decimal point indicates a #.)

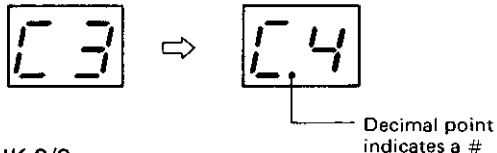

⑥ BANK 2/8 BANK 2/8

13 29

This changes the voice program selection method for play mode. The upper readout will show **BN**. Each time you press this switch, the lower readout will alternate between 2 and 8.

⑦ SAVE

SAVE

15 31

All the settings and assignments made in CA mode may be stored in one of 16 code memories. Use bank B program select switches 1-16 to choose the code memory you want to save the current settings in. The selected number will blink in the lower readout, and when you press that same number again, all current settings will be stored in that code memory as follows.

- All controller code assignments and bank A/B enable/disable settings made in CA mode.
- Transpose points A and B
- Bank select 2/8
- Split point
- Bank A and B channel numbers

⑧ LOAD

LOAD

16 32

Use this to recall the setting you saved in 7.

When you press this switch, the upper readout will show LO. Use bank B program select switches to select the desired code memory.

■ INTERNAL FUNCTIONS

Controller codes 00-3F have been preset with various functions. When in PLAY mode, if you operate a controller that has been assigned one of these controller codes, this is what happens:

00 SINGLE

The keyboard mode changes to SINGLE, and sends key on/off information on either bank A or B.

01 DUAL

The keyboard mode changes to DUAL, and sends key on/off information on both banks A and B.

02 SPLIT/SPLIT POINT

The keyboard mode changes to SPLIT, and sends key on/off information from the lower part of the keyboard on bank A, and the upper part on bank B. If this is activated while already in SPLIT mode, the upper readout will display **SP**, and the lower will display the current split point. The next key you touch will be the new split point. If you do not want to change the split point, press MODE.

03 SWAP CHANNEL

This interchanges the MIDI channel numbers of banks A and B. The voice program numbers in the readouts will change places.

04 MIDI CHANNEL

The readouts will display the MIDI channel numbers for banks A and B.

Hold down the controller and press bank switch A or B, and the selected bank readout will start blinking. Now you may enter the new channel number for that bank by pressing one of the Bank B program select switches. When you release the switch, the readout will return to its usual display.

07 LOAD

Press and hold down the controller. Use the bank B program select switches to select the code memory you want to load (recall).

08 A OCTAVE UP

09 B OCTAVE UP

0A A OCTAVE DOWN

0B B OCTAVE DOWN

These four switches transpose bank A or B up or down one octave.

0C CHANNEL INCREMENT 1

0D CHANNEL DECREMENT 1

0E CHANNEL INCREMENT 2

0F CHANNEL DECREMENT 2

These four switches move the MIDI channel up or down 1 or 2. Both banks are affected simultaneously. The new MIDI channel number will be displayed for about 0.5 seconds. If the number goes beyond 16 or 1, it will come around to 1 or 16.

16 DATA ENTRY

This corresponds to the data entry slider on the DX series synthesizers.

26 INCREMENT

27 DECREMENT

These correspond to the +1, -1 switches on the DX series synthesizers.

30 SONG SELECT

The upper readout will display SS. Now, select song 0-9 by pressing bank B program select switches 1-10. (The numbers above the bank B program select switches are used with this function.)

31 MIDI CLOCK

When this controller code has been assigned to Wheel 1-Foot Controller 2, the KX88/76 will send MIDI tempo clock data at a tempo of $J = 40-240$, according to the position of the controller.

Note about controller codes:

The KX88/76 will send any type of MIDI data. However, some MIDI devices may not accept certain messages.

Consult the MIDI data list for that device.

■ PA MODE

① CONTROL CHANGE

11 27

CONTROL CHANGE

Use this to define controller codes 40-FF as MIDI control change messages.

When you press this switch, the upper readout will show **CC**. Enter the controller code number you want to define, and the readout will show 00. Now enter the MIDI control number (00-7F) (List on p. 24). Next, enter the data type. The data type is significant only if this controller code is assigned to Foot Switch 1 or 2. Regardless of the data type, TS1, 2 and MS1-5 will not send anything when turned off.

Data Type	Switch On	Switch off
0	Transmits 7F	Transmits 00
1	Transmits 7F	Nothing
2	Transmits 00	Nothing

Data Type 0 – Turns the function on when the footswitch is depressed and off when the footswitch is released.

Data Type 1 – Turns the function on when the footswitch is depressed. Releasing the pedal has no effect.

Data Type 2 – Turns the function off when the footswitch is depressed. Releasing the pedal has no effect.

② PARAMETER CHANGE

12 28

PARAMETER CHANGE

Use this to define controller codes 40-FF as SYSTEM EXCLUSIVE: PARAMETER CHANGE messages. When you press this switch, the upper readout will show **PC**. Enter the controller code you want to define. The upper readout will show **LM** (Limit) and the lower readout will show **OF** (Off). This allows you to select an upper limit for the data of the parameter change. Use the bank B program select switches 1-6 to select an upper limit of 3, 7, 15, 31, 63 or 99. If you press bank B switches 7-16, the limit will be off. (127 max)

B
 1
 2
 3
 4
 5
 6
 7
 8
 ~
 16

LIMIT 3 7 15 31 63 99 127

After you have specified the limit, the upper readout will show G. Enter the group number (00-1F) of the parameter you want to change. Next, the upper readout will show SG, so enter the subgroup (0-3). Next, the upper readout will show P, so enter the parameter number (00-FF).

NOTE: System Exclusive messages include an ID number which is different for each manufacturer. Controller codes you define using PARAMETER CHANGE will affect only Yamaha equipment. To define System Exclusive messages for other manufacturer's products, use the Universal Parameter function.

③ UNIVERSAL PARAMETER

13 29

UNIVERSAL PARAMETER

Using this, you may define controller codes 3E and 3F as any MIDI message of up to 8 bytes. The controller data (00-7F) will be included in this message in whatever spot you specify.

When you press this switch, the upper readout will show UP. Now choose Universal 1 or 2 (controller code 3E or 3F) by pressing bank B program select switches 1 or 2. The readout will show b1, prompting you to enter the first byte. As you enter each byte, the upper display will show which byte you are now entering. At the place you want the controller data to fit in, press bank B switch, and the lower display will show dA (data). When you finish, press PARAMETER CHANGE switch again.

④ MANUAL DATA DUMP

16 32

MANUAL DATA DUMP

The upper readout will show MD. Now use bank B program select switches 0-F to enter up to 20 bytes of MIDI information.

The last byte you entered will be displayed in the upper readout. When you have finished, press MANUAL DUMP again, and the string of data you inputted will be sent.

NOTE: This data will not be stored in the KX88/76's memory. It is sent and forgotten.

⑤ CHECKING CONTROLLER CODES

If while in PA mode, you enter a controller code number (using bank B program select switches), the data for that controller code will be displayed for about 1 second, as follows.



- Undefined (NOP)
aa = 00



- SYSTEM EXCLUSIVE PARAMETER CHANGE
aa : LIMIT → MAX value
bb : 00 ~ 1F → GROUP NO.
after 0.5 seconds



- c : 0 ~ 3 → SUB GROUP NO.
dd : 00 ~ 7F → PARAMETER NO.



- INTERNAL FUNTION
No display



- Other status
aa = D0 → AFTER TOUCH
= E0 → PITCH BEND
= F3 → SONG SEL.
= F6 → TUNE REQ
= F8 → MIDI CLOCK
= FA/FB/FC → START/CONT./STOP
= FF → SYSTEM RESET



- CONTROL CHANGE
aa : 0 ~ 7FH → CONTROL NO.
b : 0 ~ 2 → DATA TYPE

SPECIAL FUNCTIONS

- ① MIDI STATUS AND ACTIVE CLOCK disable
The KX88/76 normally sends MIDI status and active clock signals, but you may disable this by turning the power on while pressing the MODE switch.
- ② MEMORY INITIALIZE
By turning on the power while pressing bank switches A and B, you can set all code memories to the initial setting on page 33. (Obviously, this wipes out everything you have set.)
The readouts will display 0 for both A and B.
- ③ When the memory backup battery runs low, the readout will display L0 bA when you turn the power on. Press any button to return to play mode. If this happens, contact your Yamaha dealer.
- ④ ERROR MESSAGES
When an error occurs, the upper readout will show Er, and the lower will show the following codes.
Error 1. Serial input overrun, framing error.
Error 2. MIDI input buffer overflow.
Error 3. The MIDI active sensing clock was interrupted for more than 300 m sec.
- ⑤ MIDI INPUT
The KX88/76 sends out exactly what comes in to the MIDI input. (echo back) You may think of it as a MIDI mixer. The KX88/76 will not "process" incoming MIDI data.

MIDI BULK DATA DUMP

• BULK DUMP ON DUMP REQUEST

When the KX receives a bulk data dump request with format number 126 (see page 13) on the MIDI channel that bank A is receiving, it will send the following MIDI bulk data.

- MIDI Reception channels of banks A and B
- Key assign mode
- Split point
- Bank 2/8
- Transpose points A and B
- Assignments of each controller

NOTE: All the above data is sent for code memories 1 ~ 16.
Controller code definitions 40 ~ FF.

• BULK DATA RECEPTION

When the KX receives bulk data as described above, all internal memory will be replaced with the new data, and the LED will show AF (All Function).
BULK DUMP (This is transmitted when a dump request is received.)

● SENDING A DUMP REQUEST FROM THE KX

You can transfer the memory of one KX to another KX by connecting the MIDI OUT of one to the MIDI IN of the other, and vice versa. (You will need 2 MIDI cables.)

In order for a KX to transmit bulk data, it must receive a dump request. (There is no function in the KX that lets it transmit bulk data on its own.)

Remember, the KX that sends the dump request will have its memory wiped out by the new, incoming data.

There are two ways to send a dump request.

1. USING MANUAL DATA DUMP

- ① Enter PA mode and press MANUAL DUMP.
- ② As described on page 25, enter the following MIDI message;

Status	F0	System Exclusive
ID	43	Yamaha ID number
Substatus/ch.	2n	(n = channel number 0 ~ F 0 = ch 1, F = ch 16)
Format number	7E	(7E hex = 126 decimal)
EOX	F7	End of Exclusive

For example, if you wanted to send the dump request on MIDI channel 2, you would enter the following 5 bytes; F0, 43, 21, 7E, F7. Then, press MANUAL DUMP again and the dump request will be sent.

2. USING UNIVERSAL PARAMETER

MANUAL DUMP has the disadvantage that the data is not memorized by the KX. So, you may want to define a Universal Parameter as a dump request message.

- ① Enter PA mode and press UNIVERSAL PARAMETER.
- ② Select Universal 1 or 2.
- ③ Enter the MIDI dump request message as shown above.
- ④ Go back to CA mode and assign the Universal Parameter to a controller (for example, MS1 ~ 4).
- ⑤ Go back to PLAY mode. When you press that controller, the dump request will be sent.

NOTE: The KX can also send and receive bulk data to and from the QX1. See the QX1 manual.

PRECAUTIONS WHEN USING THE KX88/76 WITH THE DX7

- ① For the DX7 to accept parameter change messages, it must be set to SYS INFO AVAIL.
- ② When you change a function (for example portamento time) from the KX88/76, the portamento time of the DX7 will change, but the DX7 display will not indicate this.
- ③ While you are modifying a DX voice parameter, the sound will be interrupted. This is the same whether you do this from the DX or from the KX.
- ④ When you use Parameter Change, make sure the data limit is correct for that particular parameter.

BEFORE YOU PANIC

● IF THERE IS NO SOUND

- ① Is the tone generator connected to an amplifier and speaker correctly? Are all volume controls (amp and tone generator) set above 0?
- ② Are all MIDI connections and settings correct? KX MIDI OUT connected to tone generator MIDI IN? Reception channel of tone generator set to match transmission channel of KX? (Or tone generator is set to OMNI ON.)
- ③ Is the tone generator Note Limit (eg. for TX7) set to a range outside the keyboard? Is the KX transpose function set to a range beyond the tone generator's capabilities?
- ④ Has a KX controller been set to control volume and been left at minimum position?

● IF THE SOUND DOES NOT STOP EVEN IF YOU RELEASE THE KEY

- ① Are you in CA mode? Controllers will not operate in CA mode, so if you press the sustain pedal and enter CA mode, the KX will not realize that you have released it. Go back to PLAY mode and press and release the sustain pedal.
- ② Has the MIDI cable been pulled out? If so, the tone generator has not received the Key Off signal.

CHAPTER 3: SETTING UP THE KX88/76

CA (controller assign) MODE

In the last chapter, we learned what functions had been assigned to the controllers when the KX88/76 left the factory. In this chapter, we will learn how to assign any function to any controller.

Most of the frequently used functions have been stored in the KX88/76's memory and given a number—a CONTROLLER CODE. (These CONTROLLER CODES are printed on the upper right part of the KX88/76's panel.)

The steps in assigning a controller are

1. Select a controller. (bank A switches 1-10, TS, MS and FS switches)

2. Enter the controller code. (bank B switches 0-F)

To say it another way, you must decide

1. Which controller?

2. Does what?

Readout display codes

	T1	TOGGLE SWITCH 1
	M1	MOMENTARY SWITCH 1
	W1	WHEEL 1
	BC	BREATH CONTROLLER
	AC	AFTER TOUCH CONTROLLER
	C1	CONTINUOUS SLIDER 1
	F1	FOOT CONTROLLER 1
	S1	FOOT SWITCH 1
	CA	CONTROLLER ASSIGN
	PA	PARAMETER ASSIGN
	SA	SAVE
	BN	BANK
	SP	SPLIT POINT
	LO	LOAD
	SS	SONG SELECT
	PC	PARAMETER CHANGE
	CC	CONTROL CHANGE
	UP	UNIVERSAL PARAMETER
	MD	MANUAL DUMP
	LM	LIMIT
	ON	ON
	OF	OFF
	G	GROUP NO.
	SUB	GROUP NO.
	P	PARAMETER NO.
	TP	TRANPOSE
	CH	CHANNEL

EXAMPLE 1 Wheel 2 = Volume

Let's try assigning Wheel 2 (W2) to Volume. (W2 = Volume)

① Enter CA mode by pressing the MODE switch.

The LED will indicate CONTROLLER and the readout will show .

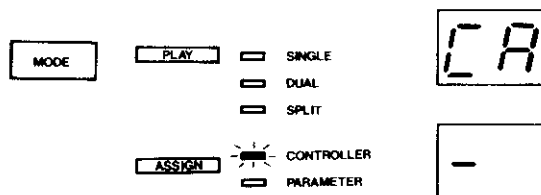

② Now, we must choose which controller we are assigning—in this case W2. Above the bank A program selector switches 1-10 you will see the various controllers indicated. Select Wheel 2 by pressing program selector switch 2. The upper readout will show which controller you have selected.

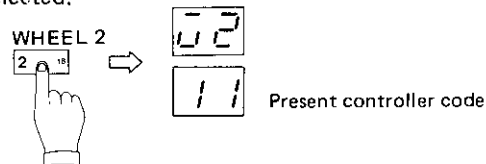

③ Now, using the bank B program select switches 1-F, enter the CONTROLLER CODE you want to assign to Wheel 2. In this case, volume, which is controller code 17. Press bank B program select switch 1 and then 7.

NOTE: In CA mode, the numbers of the select switches go from 0 to F, as is written above the switches.

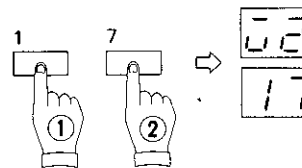

The lower display will show the controller code you have entered. (17)

④ Controllers (wheels, pedals, footswitches, switches, sliders) will work only in PLAY mode. So, to try out the new assignment you have made (Wheel 2 = Volume), go back to PLAY mode and move Wheel 2. The volume should change accordingly.

- To assign controllers which are not listed above the bank A program select keys (TS, MS and FS), simply press that controller. For example, if you wanted to assign MS1, press MS1 while you are in CA mode. The upper readout will indicate MS1 and the lower will indicate the present controller code. Use the bank B switches 0-F to enter the new controller code. If you do not want to change the controller code, just press another controller select switch or go back to PLAY mode.

- Controllers send MIDI signals only when moved. So for instance, if you hold down the Foot Switch 1 (FS1 = Sustain) and enter CA mode, the sustain will continue even if you release the foot switch. (Controllers operate only in PLAY mode.) When this happens, go back to PLAY mode and press and release the foot switch.

EXAMPLE 2 TS1 = A OCT UP, A OCT DOWN

Now let's assign a new function to the Toggle Switch 1 (at present assigned to MONO, POLY). The Toggle Switches TS1 and TS2 are different from the other controllers. They can each be assigned two functions: one when pushed on (LED lights up) and one when pushed off (LED goes off). In this example, the two functions will be to transpose MIDI bank A up and down an octave.

- 1 Enter CA mode by pressing the MODE switch.

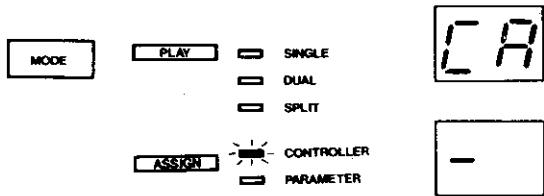

- 2 Choose the controller. TS1 is not marked above the bank A program select switches. So, press TS1. The upper readout will display T1 for about 0.5 seconds, and then the two present controller codes will be displayed.

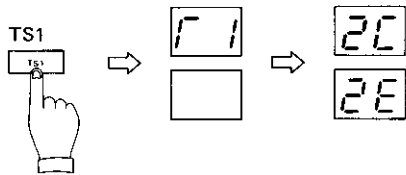

- 3 Using the bank B program select switches, enter the controller code for the first function. (08 A OCT UP) The controller code you have just entered will be displayed in the upper readout.

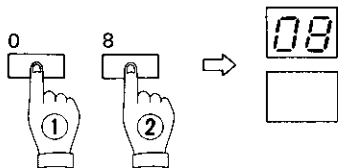

- 4 Enter the controller code for the second function. (0A A OCT DOWN) This will be displayed in the lower readout for about 0.5 seconds and then it will return to displaying CA.

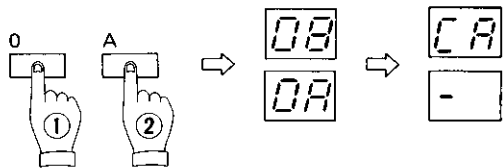

- 5 Go back to PLAY mode and try out the new function you have assigned. When you press TS1, the LED will light and the tone generator receiving MIDI bank A will play an octave higher than before. Press TS1 again. The LED will go off and the tone generator will come back down an octave.

This example used controller codes (08 and 0A) that were predefined to affect only one MIDI bank, but you can set any assignment to affect either or both MIDI banks.

EXAMPLE 3 CS1 = MASTER TUNE (bank A)

Let's make a controller assignment that will affect only MIDI bank A.

- 1 Enter CA mode.
- 2 Press CS1. The upper readout displays C1 and the lower readout displays the current controller code.

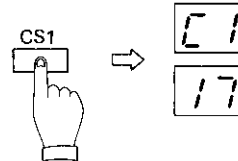

- 3 Notice that bank LED A and B are both on. This means that this controller assignment is affecting both MIDI banks. Press bank switch B, and the bank B LED will go off.

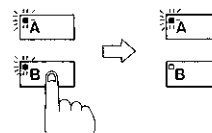

- 4 Now enter the new controller code. (38 MASTER TUNE)

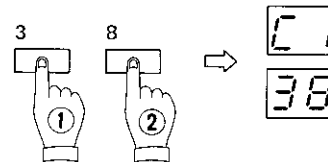

This assignment will be active only for MIDI bank A.

- 5 Go back to PLAY mode and try it out. When CS1 is in the center position, the two tone generators will be in tune. As you move CS1, the tuning of the tone generator receiving MIDI bank A will change. Try using the same voice program for both tone generators, and you will get a nice detune-chorus effect.

EXAMPLE 4 FC1 = PITCH BEND (Bank B)

Here's a rather interesting assignment; use the foot controller to pitch bend only one of the MIDI banks.

- ① Enter CA mode.
- ② Select Foot Controller 1.

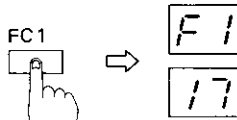

- ③ Disable bank A by pressing bank switch A. (the LED goes off)

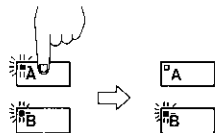

- ④ Enter the new controller code. (10 PITCH BEND)

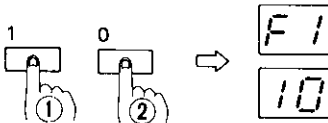

- ⑤ Go back to PLAY mode and try it out. When the foot controller is in the center of its travel, the pitch bend will be zero. Pushing up or down on the pedal results in a pitch change.

EXAMPLE 5 FS1 = SUSTAIN (A), FS2 = SUSTAIN (B)

Let's give banks A and B separate sustain foot switches.

- ① Enter CA mode.
- ② Press FS1.

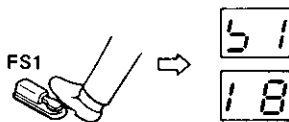

- ③ Disable bank B by pressing bank switch B.

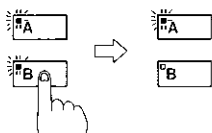

- ④ Enter the controller code. (18 SUSTAIN ON/OFF)

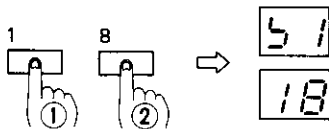

- ⑤ Repeat steps 2-4, with FS2 and disabling bank A.
- ⑥ Go back to PLAY mode and try it out. This assignment is especially nice in split mode. You can sustain notes on the lower part of the keyboard while playing staccato on the upper part.

EXAMPLE 6 CONTROLLING A RHYTHM MACHINE OR SEQUENCER

This KX88/76 is not limited to sending keyboard information. Let's set it up to control a rhythm machine (such as the RX15) and/or a sequencer (such as the QX1). With two momentary switches and a continuous slider, we will send Start, Stop and MIDI Clock information.

- ① Enter CA mode.
- ② Select MS4.

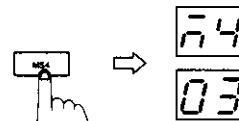

- ③ Enter the controller code. (32 START)

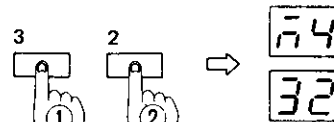

- ④ Select MS5.

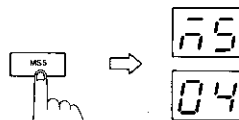

- ⑤ Enter the controller code. (34 STOP)

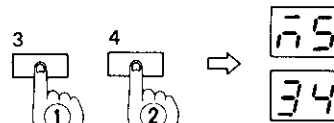

- ⑥ Select CS2.

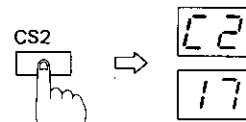

- ⑦ Enter the controller code. (31 MIDI CLOCK)

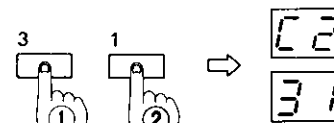

- ⑧ Go back to PLAY mode and try it out. You will need to connect a rhythm machine or sequencer to the KX88/76 as shown below.

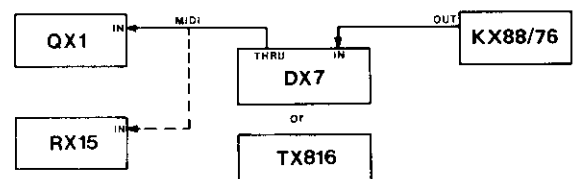

When you press MS4, the rhythm machine or sequencer will start, and when you press MS5 it will stop. Adjust the tempo with CS2.

■ OTHER FUNCTIONS IN CA MODE

● MIDI CH

MIDI CH

11 27

When you press this switch, the MIDI channels of banks A and B will be displayed in the readouts.

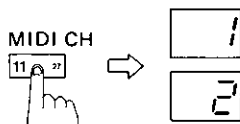

If you want to change MIDI channels A or B, press bank switch A or B and the selected readout will start blinking.

Enter the new MIDI channel by pressing one of the bank B program switches 1-16. The new channel number will be displayed.

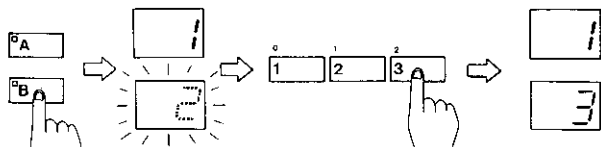

This function may be selected while in PLAY mode by assigning a controller to controller code 04.

● TRANPOSE

TRANPOSE

12 28

The KX88/76's keyboard may be transposed up or down in half-steps, to a maximum of +2 octaves. When you press this switch, the readouts will display the current transpose points for MIDI banks A and B.

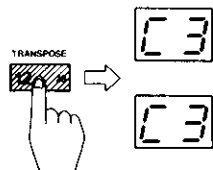

As originally set up, the transpose point will be C3 for both banks, meaning that pressing C3 on the keyboard will send a C3 key on signal to both channels (i.e. normal position). If you want to change the transpose point, press bank switch A or B to choose which bank you are transposing. The selected bank readout will start blinking.

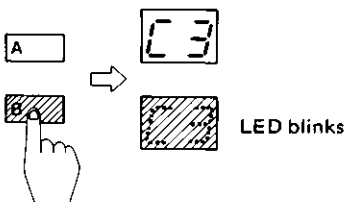

Then, press a key. The new transpose point you have selected will be displayed.

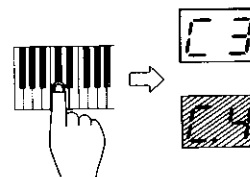

(A decimal point indicates a sharp.)

The limit is ± 2 octaves from C3. If you press a key above C5, C5 will be selected, and if you press a key below C1, C1 will be selected.

This function may be selected while in PLAY mode by assigning a controller to controller code 05.

However, if, for example, you assign transpose to MS1, you must hold down MS1 while selecting the bank to be transposed.

● BANK 2/8

BANK 2/8

13 29

This lets you switch between 2 BANK and 8 BANK mode. Each time you press the BANK 2/8 switch, the upper readout will display BN (bank number) and the lower readout will alternate between 2 and 8.

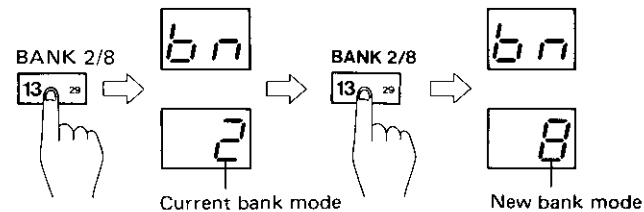

To leave this function, press any other switch.

The Yamaha DX and TX voice program memories are 1-32. However, some MIDI synthesizers may have up to 128 voice program memories. To select voice programs 1-128, set it in 8 BANK mode. For the details of selecting voice programs in 8 BANK mode, see page 21.

● SAVE

SAVE

15 31

The KX88/76 has 16 CODE MEMORIES. Everything you assign or set in CA mode can be stored in one of these memories. When you press SAVE, the upper readout will display SA.

Use the bank B select switches 1-16 to choose which code memory you are going to store the current settings in.

The selected number will blink in the lower display, allowing you to double check. If that is the code memory that you want to use, press that same number again, and all the current settings will be saved in that code memory. Naturally, the previous setting will be erased.

Let's save the assignments you have made so far (if you have been following the examples) in code memory 2. Press SAVE and then press bank B program switch 2.

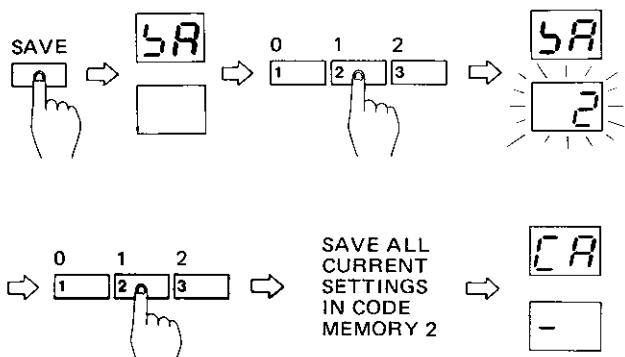

This number will blink in the lower display. Press 2 again and all the settings you have made will be stored in this code memory.

• LOAD

LOAD

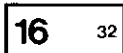

Use this to LOAD (recall) one of the settings saved in the 16 code memories. When you press LOAD, the upper display will show **LO**. Now choose one of the code memories by pressing one of the bank B select switches 1-16.

This function may be selected while in PLAY mode by assigning a controller to controller code 07.

Let's LOAD code memory 1. (This memory still has the initial assignments and settings.) Make sure you SAVE the current settings first, or else they will be gone forever. Press LOAD and then bank B select switch 1.

Go back to PLAY mode and try using the controllers. TS1 = MONO, POLY; CS1 = VOLUME A; WH2 = MODULATION etc.

Now, try recalling the setting that you stored in code memory 2. (see LOAD)

TS1 = OCTAVE UP/DOWN; CS1 = TUNE A; WH2 = VOLUME etc.

Each controller can have totally different functions in each setting, and it can be difficult to remember just what is in each code memory, so we suggest that you keep a memo of each settings. You may copy the form on page 33.

We have finished our explanation of CA mode.

Experiment, and try out your own ideas. We suggest that you leave code memory 1 as it is (the original setting). That way, if you become totally confused, you'll have a familiar setting to come back to.

PA (Parameter Assign) MODE

In the last section (CA mode), we learned how to assign controller codes to controllers. Controller codes 00-3F and their definitions are printed on the KX88/76. These controller codes cannot be redefined. However, you may define the remaining controller codes 40-FF to be any MIDI information you want.

The basic procedure in PA mode is:

1. Enter a controller code (40-FF)
2. Enter MIDI data for that controller code.

■ FUTURE USES OF PA MODE

There are still some undefined messages in MIDI. This is because musical instrument manufacturers have agreed to leave room for future developments. When this happens, you will use PA mode to define controller codes as these new MIDI messages.

Depending on what type of MIDI data you want to send, there are 3 main functions in PA mode (bank A select switches 11-13).

■ CONTROL CHANGE



CONTROL CHANGE

Use this to define a controller code as a MIDI CONTROL CHANGE. (Pitch bend, after touch, breath controller, foot controller etc. are Control Changes.)

Most MIDI data is sent in groups of three "bytes". (pieces of information) Let's use the Modulation Wheel as an example. When the Modulation Wheel is moved, three MIDI bytes (numbers from 00 to FF) are sent. The first one announces "This is a Control Change and it's coming on MIDI channel 1 (or whatever channel it happens to be)." The second byte says "This is the Modulation Wheel." And the third byte tells the current position of the Modulation Wheel.

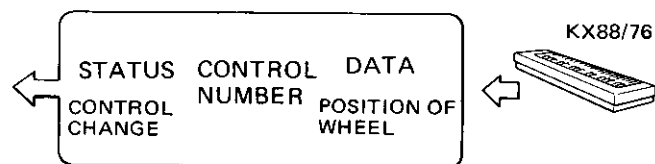

When you use CONTROL CHANGE, you must enter this second byte. In other words, you will decide the new identity of the controller. MIDI control change data is included in chapter 4 of this manual on page 28.

EXAMPLE 7 Controller Code 40 = Modulation Wheel

Actually, most of the MIDI control changes you will use are already preset as controller codes 10-27. But just as an example, let's define controller code 40 as Modulation Wheel. The MIDI control change number for Modulation Wheel is 01. (see MIDI data list on page 28)

- Enter PA mode by pressing the mode switch for about 1 second while in CA mode. The upper readout will show PA.

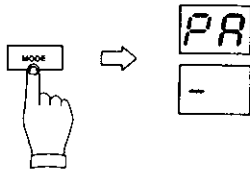

- Press bank A switch 11 (CONTROL CHANGE). The upper readout will show CC.

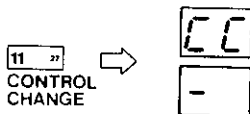

- Enter the controller code that you want to define (in this example, 40), using the bank B switches 0-F.

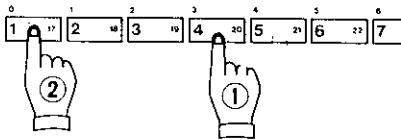

- Enter the MIDI control number you want. (in this example, 01)

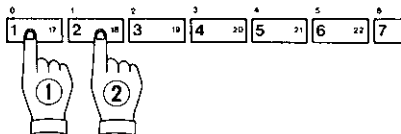

- Enter the DATA TYPE. (0, 1 or 2) This will only apply to Foot Switches 1 and 2. (for details, see page 11.) For now, just enter 0.

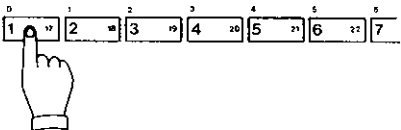

- Go to CA mode and assign controller code 40 to a controller, for instance CS1. Then, go to PLAY mode and try out CS1. It will perform the same function as the Modulation Wheel.

In reality, of course, it would have been much simpler just to assign controller code 11 (which is already preset as Modulation Wheel), without bothering with PA mode. The above example is for your future reference.

PARAMETER CHANGE

PARAMETER CHANGE



Use this to define a controller code as a SYSTEM EXCLUSIVE: PARAMETER CHANGE. System Exclusive messages include an ID byte which is different for each manufacturer. So, controller codes you define here will affect only Yamaha MIDI products. You may use Parameter Change to change any voice parameter of the tone generating unit.

EXAMPLE 8 Controller Code 41 = Op. 6 Frequency Fine

As an example, let's try changing the Op. 6 Frequency Fine of the DX7 (or TX).

- Enter PA mode from CA mode (if you are not already in), by pressing MODE for about 1 second. The upper readout will show PA.

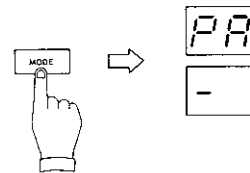

- Press bank A switch 12. (PARAMETER CHANGE) The upper readout will show PC.

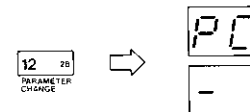

- Enter the controller code you want to define, using the bank B switches 0-F. In this case, let's define controller code 41.

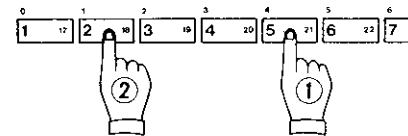

- The upper readout shows LM (Limit). This is where you set an upper limit to the data number. If you check the DX, you will find that the Op. 6 Frequency Fine has a range of 0 to 99. So, choose a limit of 99 by pressing bank B switch 6. (For details why, see page 11)

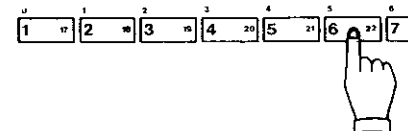

- Now the upper readout will show G. (Group) Look in the DX7 MIDI data list and find the group number for the parameter you want. In this case it is 00, so enter 00.

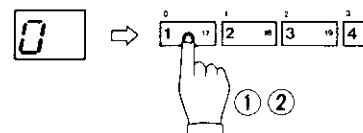

- ⑥ Next, the upper readout will show SG (Subgroup). Enter the appropriate subgroup. For this example, 0.

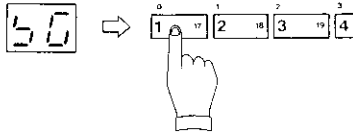

- ⑦ Now the upper readout will show P (Parameter), so enter the parameter number. The parameter number for Op. 6 Frequency Fine is 13 (Hexadecimal).

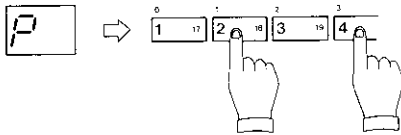

- ⑧ Now go back to CA mode and assign Controller Code 41 to a controller, for example CS3. Then, go to PLAY mode and try out the new assignment you have made. As you move the slider, the harmonic structure of the sound should change interestingly.

REMEMBER!

For the DX to accept parameter change messages, it must be set to SYS AVAIL.

Also, each time you modify a parameter, the sound will be interrupted. See the precautions on page 13.

EXAMPLE 9 Controller Code 42 = Feedback

The level of feedback (in a DX operator) can affect the brightness of the sound. The effect on each voice will differ, but in general, higher feedback will mean a more brilliant sound.

- ① Enter PA mode.
- ② Press PARAMETER CHANGE.
- ③ Enter the controller code you want to define. (42)
- ④ Assign the limit. The DX series feedback has a range of 0 to 7. So, press bank B switch 2 to select a limit of 7. (For details, see page 11)
- ⑤ Now enter the group number for the parameter you want. (See the DX7 MIDI data list on page 29) In this case, 00.
- ⑥ Enter the subgroup. In this case, 1.
- ⑦ Enter the parameter number. In this case, 07.
- ⑧ Go back to CA mode and assign controller code 42 to a controller, for example CS2. Then, go to PLAY mode and try it out. By moving the slider you can make quick adjustments in the brightness of the sound. Experiment with different voices.

EXAMPLE 10 Controller Code 43 = Algorithm

DX voices can be changed drastically simply by selecting different algorithms.

- ① Enter PA mode.
- ② Press PARAMETER CHANGE.
- ③ Enter the controller code. (43)
- ④ Assign the limit. Algorithm has a range of 1 ~ 32, so press bank B switch 4 to set a limit of 31.
- ⑤ Enter the group number. (00)
- ⑥ Enter the subgroup number. (1)
- ⑦ Enter the parameter number. (Algorithm is 06)
- ⑧ Go back to CA mode and assign controller code 43 to CS3. Then, go to PLAY mode and try it out. You will find that changing the algorithm can give each DX voice many new possibilities.

EXAMPLE 11 Controller Code 44 = PITCH EG Level 1

Here's another interesting setting. It's especially effective if you enable it for only one MIDI bank.

- ① Enter PA mode.
- ② Press PARAMETER CHANGE.
- ③ Enter the controller code. (44)
- ④ Set the limit. PITCH EG Level 1 has a range of 0 to 99, so press bank B switch 6 to choose a limit of 99.
- ⑤ Enter the group number. (00)
- ⑥ Enter the subgroup number. (1)
- ⑦ Enter the parameter number. (Pitch EG Level 1 is 02)
- ⑧ Go back to CA mode and assign controller code 44 to CS3. (Disable bank B.) Then, go to PLAY mode and try it out. It will help if you set Pitch EG Rate 2 to a moderate rate (about 20). When you hit a note, the two tone generators will at first be dissonant, and then slowly resolve. Use CS3 to adjust the amount of effect. (In center position, no effect.)

By now you should have a fairly good idea of the possibilities of the KX88/76. It is important to keep a record of the settings you have made, and we suggest that you copy and use the form on page 33.

■ UNIVERSAL PARAMETER

13 29

UNIVERSAL PARAMETER

If you want to define a controller code as a SYSTEM EXCLUSIVE for a device other than Yamaha, or if you want to send any MIDI data other than Control Change or Parameter Change, use this function.

Universal 1 and Universal 2. (see Controller Code Preset Table, page 24.) In PA mode, you may use UNIVERSAL PARAMETER to define these as a MIDI message of up to 8 bytes, and include controller data in this message.

EXAMPLE 12 Universal 1 = Roland Juno 106 VCF Cutoff Frequency

Let's try controlling System Exclusive Voice Parameters of a non-Yamaha synthesizer.

- ① In PA mode, press UNIVERSAL PARAMETER. The upper readout will show **UP**.
- ② Choose Universal 1 or Universal 2 by pressing bank B program select switches 1 or 2. In this example, press switch 1.
- ③ The upper readout will show **57**, prompting you to enter the first byte. As you enter each byte, the upper readout will change **52**, **53** etc, indicating which byte you are entering.
Using bank B program select switches 0-F, enter data as show below.

Data	Explanation
F0	Status Byte — System Exclusive
41	Identification number — Roland
32	Sub status
00	Parameter group number
05	Parameter number — VCF Cutoff Frequency
55	This is where you want to insert the controller data, so press bank switch B. The lower readout will show dA for about 0.5 seconds and go on to the next byte.
F7	End of exclusive

- ④ Now, go back to CA mode and assign controller code 3E (Universal 1) to CS4. Then, go to PLAY mode and try it out. Moving CS4 will change the VCF, cutoff frequency of the Juno 106.

■ OTHER PA MODE FUNCTIONS

PA mode has two other useful functions.

● MANUAL DUMP

16 32

MANUAL DATA DUMP

Using this function, you may send a string of up to 20 bytes of MIDI data. However, this data will not be stored in memory, and will be forgotten as soon as it has been sent. See page 12 for details.

Checking Controller Code definitions.

When in PA mode (PA is displayed in the upper readout), you may check the definition of any controller code. Simply enter the controller code using the bank B switches 0-F. When you enter the controller code, the definition (ie. what MIDI data has been assigned to that code) will be displayed in the readouts for about 1 second, on p.12.

This is the end of chapter 3. Chapter 4 is intended for your reference. It has a concise summary of each function.

■ VOICE SELECTION IN 8 BANK MODE

Press Bank switch A (or B) Bank LED will blink. Now, enter the Bank number 1 ~ 8, using Bank A (or B) switches 1 ~ 8, Now select the voice program as in 2 Bank mode.

Program	LED Display
1 ~ 99	
100 ~ 128	

	1	2	3	4	5	6	7	8	9	10	11	12	13	14	15	16
1	1	2	3	4	5	6	7	8	9	10	11	12	13	14	15	16
2	17	18	19	20	21	22	23	24	25	26	27	28	29	30	31	32
3	33	34	35	36	37	38	39	40	41	42	43	44	45	46	47	48
4	49	50	51	52	53	54	55	56	57	58	59	60	61	62	63	64
5	65	66	67	68	69	70	71	72	73	74	75	76	77	78	79	80
6	81	82	83	84	85	86	87	88	89	90	91	92	93	94	95	96
7	97	98	99	100	101	102	103	104	105	106	107	108	109	110	111	112
8	113	114	115	116	117	118	119	120	121	122	123	124	125	126	127	128

KX88/76 BLOCKDIAGRAM

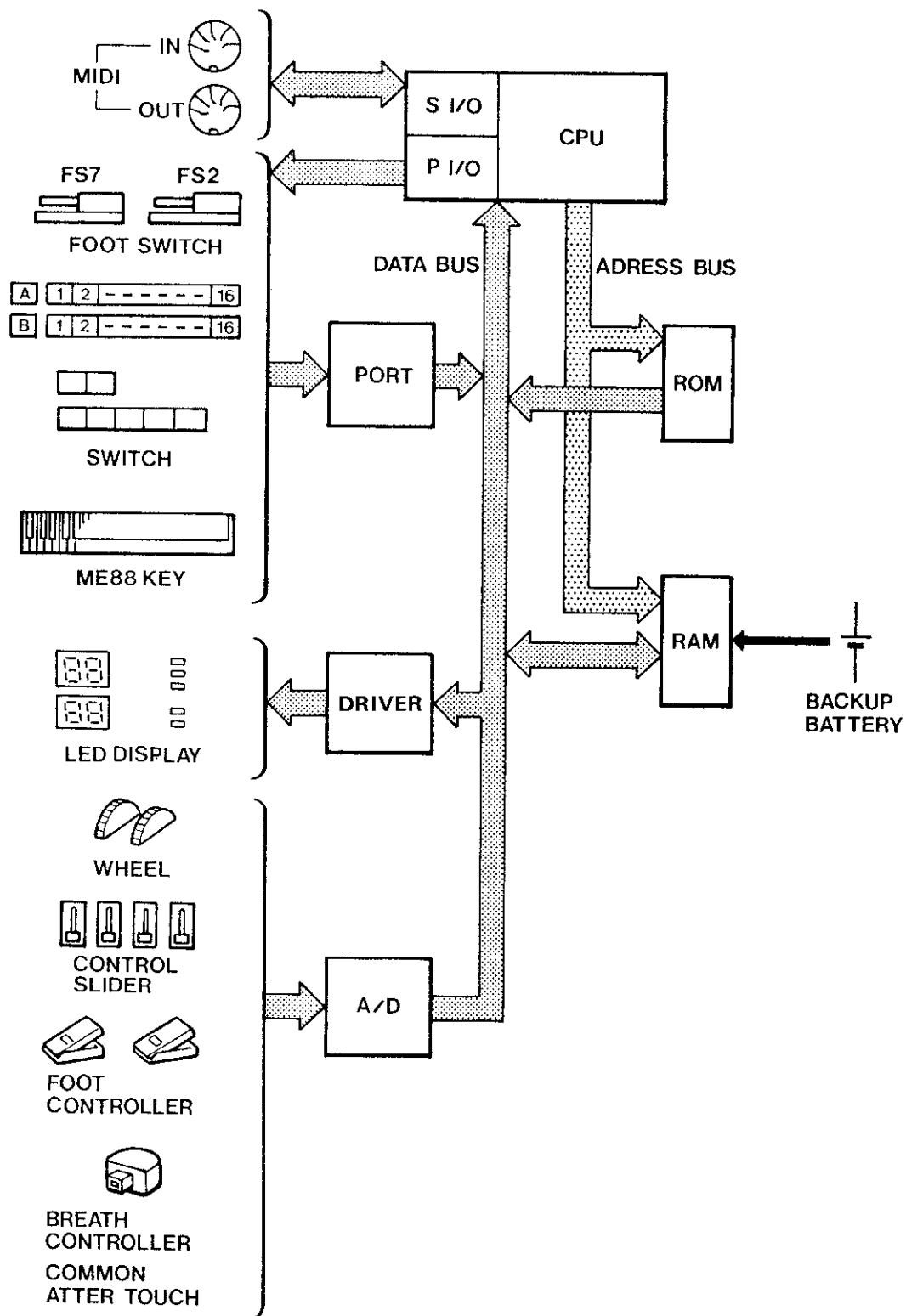

SPECIFICATIONS

Keyboard	KX88	88 keys (initial & Common after touch sensitive)
	KX76	76 keys (initial & Common after touch sensitive)
Mode Select	PLAY	SINGLE DUAL SPLIT CONTROLLER ASSIGN PARAMETER ASSIGN
Controller		WHEEL 1 – PITCH WHEEL WHEEL 2 – MODULATION WHEEL CONTROL SLIDER x 4 PUSHSWITCH TS1, 2 PUSHSWITCH MS1 ~ 5 BANKSWITCH A, B PROGRAM SELECT SWITCH BANK A 1 ~ 16 BANK B 1 ~ 16
Control Terminal		BREATH CONTROLLER INPUT FOOT CONTROLLER INPUT 1, 2 FOOT SWITCH INPUT 1, 2 MIDI OUT MIDI IN
Display		PROGRAM NUMBER 7 seg. LED x 2 PUSHSWITCH TS1, 2 ON/OFF LED x 2 KEYASSIGN, MODE LED x 5 PROGRAM, BANK LED x 2
Controller		FOOT SWITCH FC4 or FC5 FOOT CONTROLLER FC7
Power Consumption		8W
Dimensions	KX88	1,441 (W) x 131.5 (H) x 347 (D) mm (56-6/10" x 5-2/10" x 13-7/10")
	KX76	1,259 (W) x 115.5 (H) x 344 (D) mm (49-3/5" x 4-1/2" x 13-1/2")
Weight	KX88	28.5 kg (62.8 lbs)
	KX76	17.5 kg (38.6 lbs)

CHAPTER 4: FOR REFERENCE

■ CONTROLLER CODE PRESET TABLE

No.	FUNCTION	No.	FUNCTION
00	SINGLE	20	SOSTEN ON/OFF
01	DUAL	21	SOSTEN ON
02	SPLIT/S. POINT	22	SOSTEN OFF
03	SWAP CHANNEL	23	SOFT ON/OFF
04	MIDI CH	24	SOFT ON
05	TRANSPOSE	25	SOFT OFF
06	----	26	INCREMENT
07	LOAD	27	DECREMENT
08	A OCT UP	28	LOCAL ON
09	B OCT UP	29	LOCAL OFF
0A	A OCT DOWN	2A	OMNI ON
0B	B OCT DOWN	2B	OMNI OFF
0C	CH INC 1	2C	MONO 1
0D	CH DEC 1	2D	MONO 2
0E	CH INC 2	2E	POLY
0F	CH DEC 2	2F	----
10	PITCH BEND	30	SONG SELECT*
11	MOD WHEEL	31	MIDI CLOCK**
12	BREATH CTRL	32	START
13	AFTER TOUCH	33	CONTINUE
14	FOOT CTRL	34	STOP
15	PORTA TIME	35	----
16	DATA ENTRY	36	TUNE REQUEST
17	VOLUME	37	SYSTEM RESET
18	SUSTAIN ON/OFF	38	MASTER TUNE
19	SUSTAIN ON	39	DUAL MODE DETUNE
1A	SUSTAIN OFF	3A	LFO SPEED
1B	PORTA ON/OFF	3B	LFO DELAY TIME
1C	PORTA ON	3C	PITCH MOD DEPTH
1D	PORTA OFF	3D	AMP MOD DEPTH
1E	----	3E	UNIVERSAL 1
1F	----	3F	UNIVERSAL 2

MIDI OUTPUT

■ TRANSMITTED DATA AND TRANSMISSION CONDITIONS

Whatever the KX88/76 receives via MIDI IN, it will sent out via MIDI OUT, in addition to its own data. (echo back)

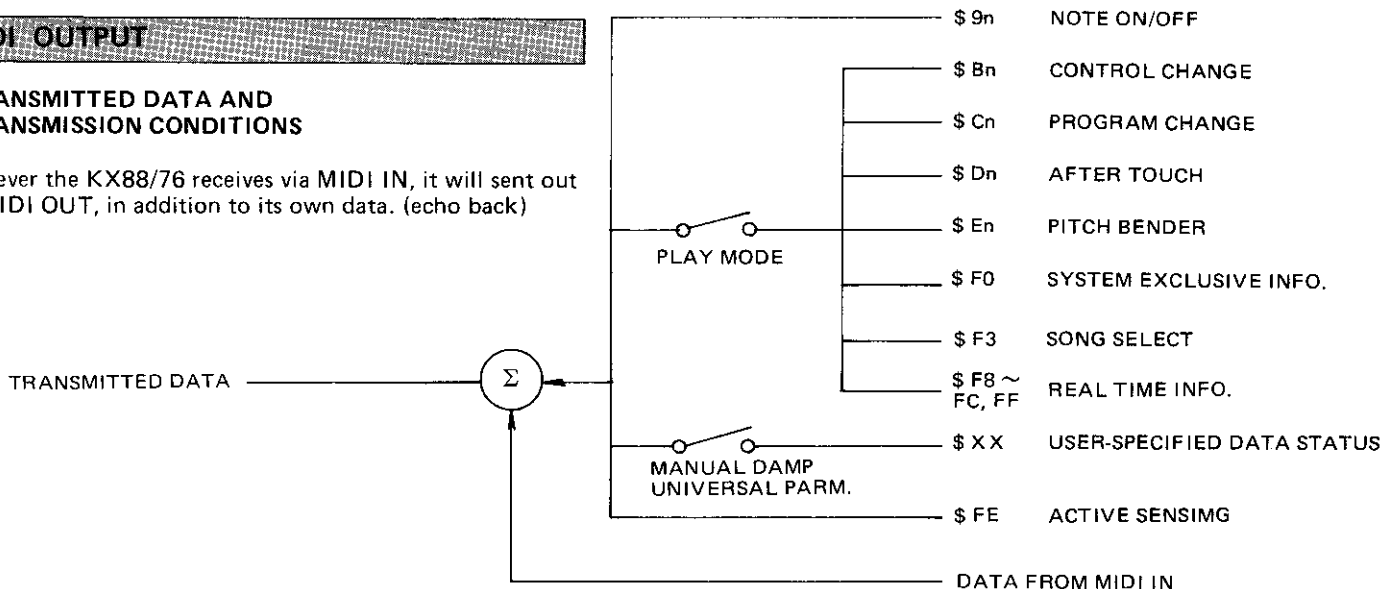

■ TRANSMITTED DATA

(Data will be sent according)

● KEY ON EVENT

1 0 0 1 n n n n KEY ON, CHANNEL NUMBER
(n = 0 ~ 15)

0 K K K K K K K KEY NUMBER: Note 1
(KX88 K 21 ~ 108)
(KX76 K 28 ~ 103)

0 V V V V V V V KEY VELOCITY (V = 0 ~ 127): Note 2

NOTE: 1. When Transpose = 0, K will change according to the transpose shift, but will not go below 0 or above 127.
2. When V = 0, KEY OFF.

● CONTROL CHANGE

1 0 1 1 n n n n CONTROL CHANGE, CHANNEL NUMBER (N = 0 ~ 15)

0 C C C C C C C CONTROL NUMBER (C = 0 ~ 127)

0 V V V V V V V CONTROL VALUE

NOTE: Data will be sent depending on the data type. (see below)

DATA TYPE	SWITCH ON	SWITCH OFF
0	V = 127	V = 0
1	V = 127	No output
2	V = 0	No output

● PROGRAM CHANGE

1 1 0 0 n n n n PROGRAM CHANGE, CHANNEL NUMBER (n = 0 ~ 15)

0 P P P P P P P PROGRAM NUMBER (P = 0 ~ 127)

● AFTER TOUCH

1 1 0 1 n n n n AFTER TOUCH, CHANNEL NUMBER (n = 0 ~ 15)

0 d d d d d d d DATA (d = 0 ~ 127)

● PITCH BENDER

1 1 1 0 n n n n PITCH BENDER, CHANNEL NUMBER (n = 0 ~ 15)

0 L L L L L L L DATA LS BYTE (L = 0 ~ 127) Note

0 M M M M M M M DATA MS BYTE (M = 0 ~ 127): Note

NOTE: When M = 0-64, L = 0
When M = 65-127, L = 2

● PARAMETER CHANGE

1 1 1 1 0 0 0 0 SYSTEM EXCLUSIVE

0 1 0 0 0 0 1 1 ID (43H)

0 0 0 1 n n n n PARAMETER CHANGE, CHANNEL NUMBER (n = 0 ~ 15)

0 g g g g g h h GROUP NUMBER (g = 0 ~ 31)

△SUB GROUP NUMBER (h = 0 ~ 3)

0 P P P P P P P PARAMETER NUMBER (P = 0 ~ 127)

0 d d d d d d d DATA: Note

1 1 1 1 0 1 1 1 EOX

NOTE: As specified by the user, this will be from 0 to 3, 7, 15, 31, 63, 99 or 127.

● TUNE REQUEST

1 1 1 1 0 1 1 0 TUNE REQUEST

● REALTIME INFORMATION

1 1 1 1 1 0 0 0 TIMING CLOCK: Note 1

1 1 1 1 1 0 1 0 START

1 1 1 1 1 0 1 1 CONTINUE

1 1 1 1 1 1 0 0 STOP

1 1 1 1 1 1 1 0 MIDI ACTIVE SENSING CLOCK: Note 2

1 1 1 1 1 1 1 1 SYSTEM RESET

NOTE: 1. Tempo is variable from 6 = 40 to 240.
2. Once this has been sent, a CLOCK signal will be sent every 150 ms if no other data has been sent in that time.

● BULK DATA

1 1 1 1 0 0 0 0 SYSTEM EXCLUSIVE

0 1 0 0 0 0 1 1 ID

0 0 0 0 n n n n CHANNEL NUMBER (n = 0 ~ 15)

0 1 1 1 1 1 1 0 FORMAT NUMBER

0 0 0 1 0 0 1 0 }
0 0 1 0 1 1 0 0 } BYTE COUNT

HEADER & DATA BYTE

0 e e e e e e e CHECK SUM

1 1 1 1 0 1 1 1 EOX

MIDI INPUT

■ RECEPTION DATA

In accordance with the YAMAHA MIDI COMMITTEE STANDARD and the MIDI 1.0 standard (version 1.0), the KX88/76 receives all MIDI data except for the undefined SYSTEM COMMON MESSAGES \$F1, \$F4 and \$F5, and their following data bytes.

OTHER SPECIFICATIONS

1. Once \$FE has been received, if data or status signals are not received within 300+10 msec, an error will be assumed. The display will indicate error, and transmission and reception will stop.
2. For output STATUS BYTES will be abbreviated. (running status)
3. When a STATUS BYTE with an incorrect number of DATA BYTES has been received, neither that STATUS nor DATA byte will be echoed back.
4. A string of up to 20 bytes of user-specified data may be sent using MANUAL DUMP.
5. Using UNIVERSAL PARAMETER, controller data may be transmitted inside a user-specified string of up to 8 bytes.
6. By a special function when turning the power on, you may cancel the abbreviation of STATUS BYTES. (running status)

■ BINARY, DECIMAL AND HEXADECIMAL CONVERSION

Conversion Table

Binary	Decimal	Hex	Binary	Decimal	Hex	Binary	Decimal	Hex	Binary	Decimal	Hex
00000000	0	0	01000000	64	40	10000000	128	80	11000000	192	C0
00000001	1	1	01000001	65	41	10000001	129	81	11000001	193	C1
00000010	2	2	01000010	66	42	10000010	130	82	11000010	194	C2
00000011	3	3	01000011	67	43	10000011	131	83	11000011	195	C3
00000100	4	4	01000100	68	44	10000100	132	84	11000100	196	C4
00000101	5	5	01000101	69	45	10000101	133	85	11000101	197	C5
00000110	6	6	01000110	70	46	10000110	134	86	11000110	198	C6
00000111	7	7	01000111	71	47	10000111	135	87	11000111	199	C7
00001000	8	8	01001000	72	48	10001000	136	88	11001000	200	C8
00001001	9	9	01001001	73	49	10001001	137	89	11001001	201	C9
00001010	10	A	01001010	74	4A	10001010	138	8A	11001010	202	CA
00001011	11	B	01001011	75	4B	10001011	139	8B	11001011	203	CB
00001100	12	C	01001100	76	4C	10001100	140	8C	11001100	204	CC
00001101	13	D	01001101	77	4D	10001101	141	8D	11001101	205	CD
00001110	14	E	01001110	78	4E	10001110	142	8E	11001110	206	CE
00001111	15	F	01001111	79	4F	10001111	143	8F	11001111	207	CF
00010000	16	10	01010000	80	50	10010000	144	90	11010000	208	D0
00010001	17	11	01010001	81	51	10010001	145	91	11010001	209	D1
00010010	18	12	01010010	82	52	10010010	146	92	11010010	210	D2
00010011	19	13	01010011	83	53	10010011	147	93	11010011	211	D3
00010100	20	14	01010100	84	54	10010100	148	94	11010100	212	D4
00010101	21	15	01010101	85	55	10010101	149	95	11010101	213	D5
00010110	22	16	01010110	86	56	10010110	150	96	11010110	214	D6
00010111	23	17	01010111	87	57	10010111	151	97	11010111	215	D7
00011000	24	18	01011000	88	58	10011000	152	98	11011000	216	D8
00011001	25	19	01011001	89	59	10011001	153	99	11011001	217	D9
00011010	26	1A	01011010	90	5A	10011010	154	9A	11011010	218	DA
00011011	27	1B	01011011	91	5B	10011011	155	9B	11011011	219	DB
00011100	28	1C	01011100	92	5C	10011100	156	9C	11011100	220	DC
00011101	29	1D	01011101	93	5D	10011101	157	9D	11011101	221	DD
00011110	30	1E	01011110	94	5E	10011110	158	9E	11011110	222	DE
00011111	31	1F	01011111	95	5F	10011111	159	9F	11011111	223	DF
00100000	32	20	01100000	96	60	10100000	160	A0	11100000	224	E0
00100001	33	21	01100001	97	61	10100001	161	A1	11100001	225	E1
00100010	34	22	01100010	98	62	10100010	162	A2	11100010	226	E2
00100011	35	23	01100011	99	63	10100011	163	A3	11100011	227	E3
00100100	36	24	01100100	100	64	10100100	164	A4	11100100	228	E4
00100101	37	25	01100101	101	65	10100101	165	A5	11100101	229	E5
00100110	38	26	01100110	102	66	10100110	166	A6	11100110	230	E6
00100111	39	27	01100111	103	67	10100111	167	A7	11100111	231	E7
00101000	40	28	01101000	104	68	10101000	168	A8	11101000	232	E8
00101001	41	29	01101001	105	69	10101001	169	A9	11101001	233	E9
00101010	42	2A	01101010	106	6A	10101010	170	AA	11101010	234	EA
00101011	43	2B	01101011	107	6B	10101011	171	AB	11101011	235	EB
00101100	44	2C	01101100	108	6C	10101100	172	AC	11101100	236	EC
00101101	45	2D	01101101	109	6D	10101101	173	AD	11101101	237	ED
00101110	46	2E	01101110	110	6E	10101110	174	AE	11101110	238	EE
00101111	47	2F	01101111	111	6F	10101111	175	AF	11101111	239	EF
00110000	48	30	01110000	112	70	10110000	176	B0	11110000	240	F0
00110001	49	31	01110001	113	71	10110001	177	B1	11110001	241	F1
00110010	50	32	01110010	114	72	10110010	178	B2	11110010	242	F2
00110011	51	33	01110011	115	73	10110011	179	B3	11110011	243	F3
00110100	52	34	01110100	116	74	10110100	180	B4	11110100	244	F4
00110101	53	35	01110101	117	75	10110101	181	B5	11110101	245	F5
00110110	54	36	01110110	118	76	10110110	182	B6	11110110	246	F6
00110111	55	37	01110111	119	77	10110111	183	B7	11110111	247	F7
00111000	56	38	01111000	120	78	10111000	184	B8	11111000	248	F8
00111001	57	39	01111001	121	79	10111001	185	B9	11111001	249	F9
00111010	58	3A	01111010	122	7A	10111010	186	BA	11111010	250	FA
00111011	59	3B	01111011	123	7B	10111011	187	BB	11111011	251	FB
00111100	60	3C	01111100	124	7C	10111100	188	BC	11111100	252	FC
00111101	61	3D	01111101	125	7D	10111101	189	BD	11111101	253	FD
00111110	62	3E	01111110	126	7E	10111110	190	BE	11111110	254	FE
00111111	63	3F	01111111	127	7F	10111111	191	BF	11111111	255	FF

CHANNEL VOICE MESSAGE (Hexadecimal)

For your information, these are the CHANNEL VOICE MESSAGES. Some equipment may not accept all of these, so consult the MIDI specifications for each device.

CHANNEL VOICE MESSAGE	BYTES				REMARKS	
	STATUS	1ST DATA		2ND DATA		
NOTE OFF	8 n	KK	Note 2	VV	Note 3	HV
NOTE ON	9 n	KK	Note 2	VV	Note 3	VV=0 : NOTE OFF
POLYPHONIC KEY PRESSURE	An	KK	Note 2	VV	Note 5	AFTER TOUCH
CONTROL CHANGE	Bn	CC	Note 4	VV	Note 5	
PROGRAM CHANGE	Cn	PP				
CHANNEL PRESSURE	Dn	VV	Note 5			AFTER TOUCH
PITCH BEND	En	LL	Note 6	MM	Note 6	

NOTE 0: n is the channel number.
n = 0-F, n = 0 is channel 1.

NOTE 1: KK is the key number.

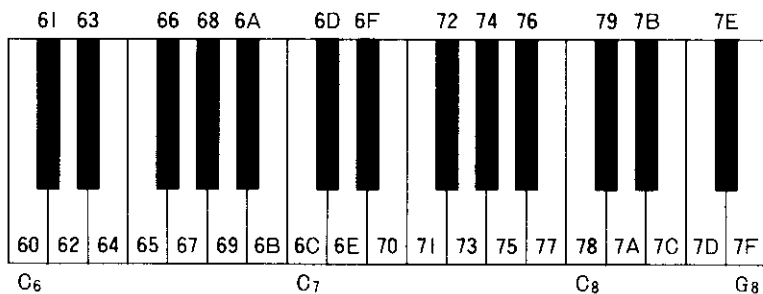
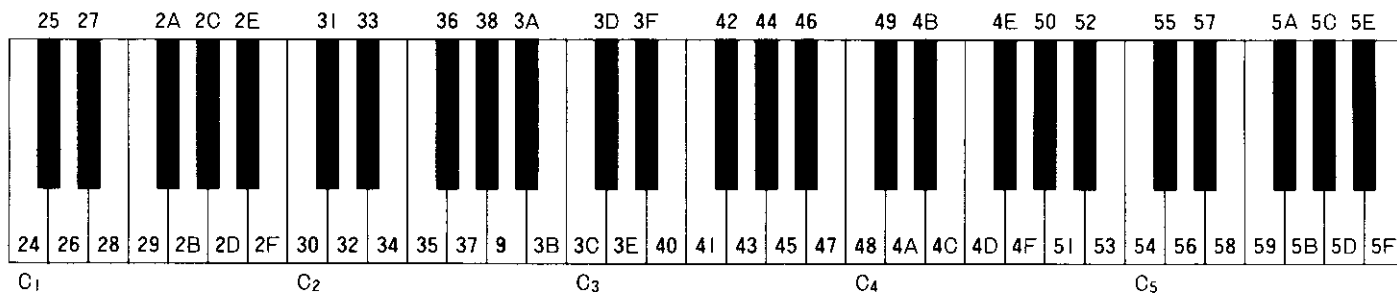
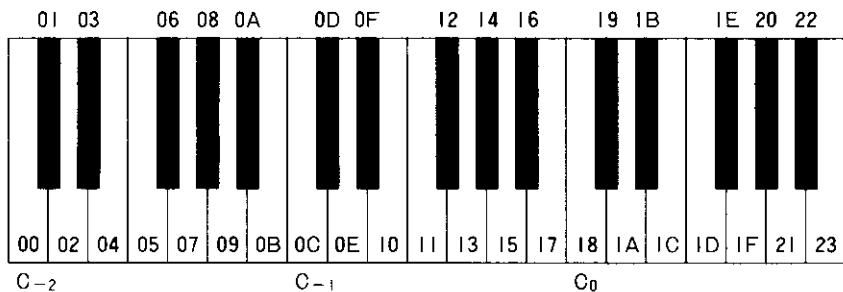

NOTE 2: VV is key velocity

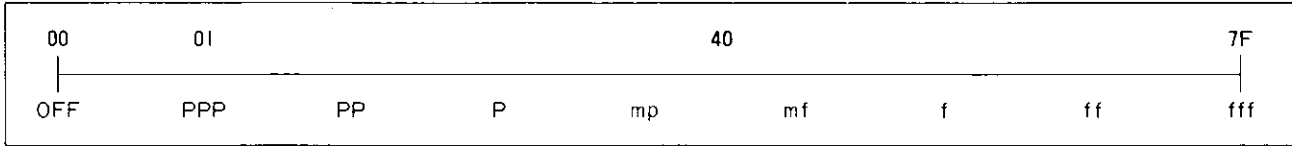

NOTE 3: CC is the Control Number. Some devices will not accept all control numbers. For your reference, here are the Control Numbers for the DX series and TX816. For other devices, consult the MIDI specifications for that device.

CONTROL NAME	CC	VV
MODULATION WHEEL	01	00 ~ 7F
BREATH CONTROL	02	00 ~ 7F
FOOT CONTROL	04	00 ~ 7F
PORTAMENTO TIME	05	00 ~ 7F
DATA ENTRY KNOB	06	00 ~ 7F
VOLUME	07	00 ~ 7F
SUSTAIN SWITCH	40	00, 7F
PORTAMENTO SWITCH	41	00, 7F
DATA ENTRY +1	60	7F
DATA ENTRY -1	61	7F

NOTE 4: VV is the controller valve or touch valve.

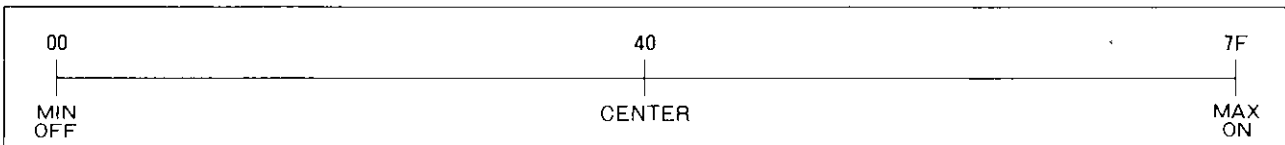

NOTE 5: UU is the least significant byte of the bend valve, and VV is the most significant byte. If only the least significant byte is changing, the most significant byte need not be sent.

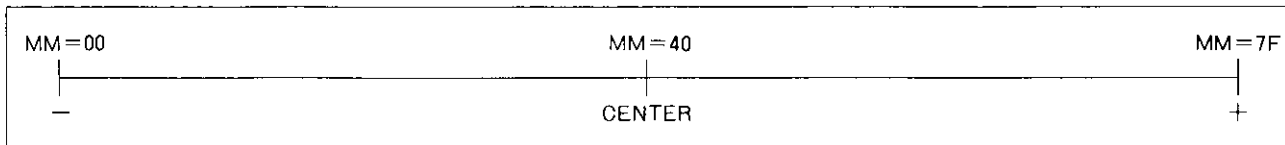

■ FOR CHANNEL MODE MESSAGES, CONSULT THE MIDI SPECIFICATIONS OF THE RECEIVING DEVICE.

DX SERIES PARAMETER CHANGE (Hexadecimal)

STATUS.....F 0 GROUP #.....gg DATA.....dd
 ID.....43 SUB GROUP #.....h
 SUB STATUS S/CH#.....ln PARAMETER #.....pp

Voice Parameter Change (gg = 00, h = 0 ~ 1)

Subgroup number h	Parameter number pp						Parameter number	Data dd		Notes
	OP6	OP5	OP4	OP3	OP2	OP1		Decimal	Hex	
0	0	15	2A	3F	54	69	EG RATE 1	0 ~ 99	0 ~ 63	
	1	16	2B	40	55	6A	EG RATE 2	0 ~ 99	0 ~ 63	
	2	17	2C	41	56	6B	EG RATE 3	0 ~ 99	0 ~ 63	
	3	18	2D	42	57	6C	EG RATE 4	0 ~ 99	0 ~ 63	
	4	19	2E	43	58	6D	EG LEVEL 1	0 ~ 99	0 ~ 63	
	5	1A	2F	44	59	6E	EG LEVEL 2	0 ~ 99	0 ~ 63	
	6	1B	30	45	5A	6F	EG LEVEL 3	0 ~ 99	0 ~ 63	
	7	1C	31	46	5B	70	EG LEVEL 4	0 ~ 99	0 ~ 63	
	8	1D	32	47	5C	71	KEYBOARD LEVEL SCALING BREAK POINT	0 ~ 99	0 ~ 63	*1
	9	1E	33	48	5D	72	KEYBOARD LEVEL SCALING LEFT DEPTH	0 ~ 99	0 ~ 63	
	A	1F	34	49	5E	73	KEYBOARD LEVEL SCALING RIGHT DEPTH	0 ~ 99	0 ~ 63	
	B	20	35	4A	5F	74	KEYBOARD LEVEL SCALING LEFT CURVE	0 ~ 3	0 ~ 3	*2
	C	21	36	4B	60	75	KEYBOARD LEVEL SCALING RIGHT CURVE	0 ~ 3	0 ~ 3	*2
	D	22	37	4C	61	76	KEYBOARD RATE SCALING	0 ~ 7	0 ~ 7	
1	E	23	38	4D	62	77	AMPLITUDE MODULATION SENSITIVITY	0 ~ 3	0 ~ 3	
	F	24	39	4E	63	78	KEY VELOCITY SENSITIVITY	0 ~ 7	0 ~ 7	
	10	25	3A	4F	64	79	OPERATOR OUTPUT LEVEL	0 ~ 99	0 ~ 63	
	11	26	3B	50	65	7A	OSCILLATOR MODE	0 ~ 1	0 ~ 1	*3
	12	27	3C	51	66	7B	OSCILLATOR FREQUENCY COARSE	0 ~ 31	0 ~ 1F	*4
	13	28	3D	52	67	7C	OSCILLATOR FREQUENCY FINE	0 ~ 99	0 ~ 63	*4
	14	29	3E	53	68	7D	OSCILLATOR DETUNE	0 ~ 14	0 ~ E	*5
				7E			PITCH EG RATE 1	0 ~ 99	0 ~ 63	
				7F			PITCH EG RATE 2	0 ~ 99	0 ~ 63	
				0			PITCH EG RATE 3	0 ~ 99	0 ~ 63	
				1			PITCH EG RATE 4	0 ~ 99	0 ~ 63	
				2			PITCH EG LEVEL 1	0 ~ 99	0 ~ 63	
				3			PITCH EG LEVEL 2	0 ~ 99	0 ~ 63	
				4			PITCH EG LEVEL 3	0 ~ 99	0 ~ 63	
			5			PITCH EG LEVEL 4	0 ~ 99	0 ~ 63		
			6			ALGORITHM SELECT	0 ~ 31	0 ~ 1F		
			7			FEEDBACK	0 ~ 7	0 ~ 7		
			8			OSCILLATOR KEY SYNC	0 ~ 1	0 ~ 1		
			9			LFO SPEED	0 ~ 99	0 ~ 63		
			A			LFO DELAY	0 ~ 99	0 ~ 63		
			B			LFO PITCH MODULATION DEPTH	0 ~ 99	0 ~ 63		
			C			LFO AMPLITUDE MODULATION DEPTH	0 ~ 99	0 ~ 63		
			D			LFO KEY SYNC	0 ~ 1	0 ~ 1		
			E			LFO WAVE	0 ~ 5	0 ~ 5	*6	
			F			LFO PITCH MODULATION SENSITIVITY	0 ~ 7	0 ~ 7		
			10			TRANPOSE	0 ~ 48	0 ~ 30	Middle is 18	
			11			VOICE NAME 1	ASC11	ASC11		
			{12, 13, 14, 15, 16, 17, 18, 19}			} (VOICE NAME 2 ~ 9)	}	}		
			1A			VOICE NAME 10	ASC11	ASC11		
1			1B			OPERATOR ON/OFF	xeeeee	xeeeee	*7	
			1C			OPERATOR SELECT	0 ~ 5	0 ~ 5	*8	

※1 BREAK POINT

BREAK POINT	Decimal	0	1	2	3	4	5	15	27	39	51	63	75	87	99
	Hex.	0	1	2	3	4	5	F	1B	27	33	3F	4B	57	63
MIDI NOTE #	Decimal	21	22	23	24	25	26	36	48	60	72	84	96	108	120
	Hex.	15	16	17	18	19	1A	24	30	3C	48	54	60	6C	78
Note name		A ₁	A ₁ #	B ₁	C ₀	C ₀ #	D ₀	C ₁	C ₂	C ₃	C ₄	C ₅	C ₆	C ₇	C ₈

※2 KEYBOARD LEVEL SCALING CURVE

	00	01	02	03
CURVE	-LIN	-EXP	+EXP	+LIN

※3 OSCILLATOR MODE

0.....FREQUENCY RATIO
 1.....FIXED FREQUENCY

※4 FREQUENCY COARSE/FINE

i) When FREQUENCY RATIO
 When FINE = 0

COARSE	Decimal	0	1	2	3	10	30	31
	Hex.	0	1	2	3	A	1E	1F
FREQUENCY RATIO		0.5	1	2	3	10	30	31

When COARSE = 1

FINE	Decimal	0	1	2	3	10	50	99
	Hex.	0	1	2	3	A	32	63
FREQUENCY RATIO		1.00	1.01	1.02	1.03	1.10	1.50	1.99

ii) When FREQUENCY FIXED
 When FINE = 0

COARSE	Decimal	0	1	2	3	4	5	6	7	31
	Hex.	0	1	2	3	4	5	6	7	1F
FREQUENCY(Hz)		1	10	100	1000	1	10	100	1000	1000





When COARSE = 0

FINE	Decimal	0	1	2	3	4	5	10	20	50	99
	Hex.	0	1	2	3	4	5	A	14	32	63
FREQUENCY(Hz)		1.000	1.023	1.047	1.072	1.096	1.122	1.259	1.585	3.162	9.772

※5 DETUNE

	Decimal	0	1	2	3	4	5	6	7	8	9	10	11	12	13	14
	Hex.	0	1	2	3	4	5	6	7	8	9	A	B	C	D	E
DETUNE		-7	-6	-5	-4	-3	-2	-1	0	1	2	3	4	5	6	7

※6 LFO WAVE

	Decimal	0	1	2	3	4	5
	Hex.	0	1	2	3	4	5
WAVE		TRIANGLE 	SAW DOWN 	SAW UP 	SQUARE 	SINE 	SAMPLE/HOLD

※7 OPERATOR ON/OFF

Bit	b ₅	b ₄	b ₃	b ₂	b ₁	b ₀
OPERATOR	OP1	OP2	OP3	OP4	OP5	OP6

Bit map *0*...OFF *1*...ON

※8 OPERATOR SELECT

	0	1	2	3	4	5
OPERATOR	OP6	OP5	OP4	OP3	OP2	OP1

DX Performance Parameter Change (gg = 01, h = 0)

Parameter number p	Parameter	Data		Notes
		Decimal	Hex	
0				
1	SOURCE SELECT	0 ~ 16	1 ~ 10	※ 3
2	POLY/MONO	0 ~ 1	0 ~ 1	
3	PITCH BEND RANGE	0 ~ 12	0 ~ C	
4	PITCH BEND STEP	0 ~ 12	0 ~ C	
5	PORTAMENTO TIME	0 ~ 99	0 ~ 63	
6	PORTAMENTO/GLISSANDO	0 ~ 1	0 ~ 1	
7	PORTAMENTO MODE	0 ~ 1	0 ~ 1	※ 1
8				
9	MODULATION WHEEL SENSITIVITY	0 ~ 15	0 ~ F	
A	MODULATION WHEEL ASSIGN	0 ~ 7	0 ~ 7	※ 2
B	FOOT CONTROLLER SENSITIVITY	0 ~ 15	0 ~ F	
C	FOOT CONTROLLER ASSIGN	0 ~ 7	0 ~ 7	※ 2
D	AFTER TOUCH SENSITIVITY	0 ~ 15	0 ~ F	
E	AFTER TOUCH ASSIGN	0 ~ 7	0 ~ 7	※ 2
F	BREATH CONTROLLER SENSITIVITY	0 ~ 15	0 ~ F	
10	BREATH CONTROLLER ASSIGN	0 ~ 7	0 ~ 7	※ 2
11				
12				
13				
14				
15				
16				
17				
18				
19				
1A	AUDIO OUTPUT LEVEL ATTENUATOR	0 ~ 7	0 ~ 7	
1B				
1C				
1D				
1E				
1F				
20				
21				
22				
3				
3F				
40	MASTER TUNING	0 ~ 127	0 ~ 7F	Center is 40

※1 PORTAMENTO MODE

- *0*... SUSTAIN-KEY PITCH RETAIN
- *1*... SUSTAIN-KEY PITCH FOLLOW

※2 EFFECT ASSIGN

BIT	b ₂	b ₁	b ₀
ASSIGN	EG BIAS	AMPLITUDE	PITCH

※3 SOURCE SELECT

CORRESPONDS TO RECEIVE BASIC CHANNEL 1 ~ 16

DX7 Function Parameter Change (gg = 02, h = 0)

Parameter number p	Parameter	Data		Notes
		Decimal	Hex.	
40	POLY/MONO	0 ~ 1	0 ~ 1	
41	PITCH BEND RANGE	0 ~ 12	0 ~ C	
42	PITCH BEND STEP	0 ~ 12	0 ~ C	
43	PORTAMENTO MODE	0 ~ 1	0 ~ 1	
44	PORTAMENTO/GLISSANDO	0 ~ 1	0 ~ 1	
45	PORTAMENTO TIME	0 ~ 99	0 ~ 63	
46	MODULATION WHEEL SENSITIVITY	0 ~ 99	0 ~ 63	
47	MODULATION WHEEL ASSIGN	0 ~ 7	0 ~ 7	
48	FOOT CONTROLLER SENSITIVITY	0 ~ 99	0 ~ 63	
49	FOOT CONTROLLER ASSIGN	0 ~ 7	0 ~ 7	
4A	BREATH CONTROLLER SENSITIVITY	0 ~ 99	0 ~ 63	
4B	BREATH CONTROLLER ASSIGN	0 ~ 7	0 ~ 7	
4C	AFTER TOUCH SENSITIVITY	0 ~ 99	0 ~ 63	
4D	AFTER TOUCH ASSIGN	0 ~ 7	0 ~ 7	

DX9 Function Parameter Change (gg = 03, h = 0)

Parameter number p	Parameter	Data		Notes
		Decimal	Hex.	
40				
41	MASTER TUNE	0 ~ 127	0 ~ 7F	
42	POLY/MONO	0 ~ 1	0 ~ 1	
43	PITCH BEND RANGE	0 ~ 12	0 ~ C	
44	PORTAMENTO MODE	0 ~ 1	0 ~ 1	
45	PORTAMENTO TIME	0 ~ 99	0 ~ 63	
46	MODULATION WHEEL SENSITIVITY	0 ~ 99	0 ~ 63	
47	MODULATION WHEEL ASSIGN : PITCH	0 ~ 1	0 ~ 1	
48	MODULATION WHEEL ASSIGN : AMPLITUDE	0 ~ 1	0 ~ 1	
49	MODULATION WHEEL ASSIGN : EG BIAS	0 ~ 1	0 ~ 1	
4A	BREATH CONTROLLER SENSITIVITY	0 ~ 99	0 ~ 63	
4B	BREATH CONTROLLER ASSIGN : PITCH	0 ~ 1	0 ~ 1	
4C	BREATH CONTROLLER ASSIGN : AMPLITUDE	0 ~ 1	0 ~ 1	
4D	BREATH CONTROLLER ASSIGN : EG BIAS	0 ~ 1	0 ~ 1	

TX Function Parameter Change (gg = 04, h = 1)

Parameter number p	Parameter	Data		Notes
		Decimal	Hex.	
0				
1				
2				
3				
4				
5	NOTE LIMIT LOW	0 ~ 127	0 ~ 7F	
6	NOTE LIMIT HIGH	0 ~ 127	0 ~ 7F	
7	TFI MEMORY PROTECT OFF/ON	0, 127	0, 7F	
8	TFI TEST PROGRAM ENTRY	127	7F	FOR FACTORY TEST
9	TFI MIDI IN INDIVIDUAL	127	7F	
A	TFI MIDI IN COMMON	127	7F	

KX88/76 CONTROLLER ASSIGN TABLE

SET NAME _____

USER NAME _____

CREATE DATE _____

MIDI CH		KEY ASSIGN MOOE	SPLIT POINT	TRANPOSE		BANK
A	B			A	B	
1	2	DUAL	C3	C3	C3	2

CONTROLLER	ENABLE		CONTROL NO.	FUNCTION
	ch A	ch B		
TS1	<input type="radio"/>	<input type="radio"/>	2C	MONO I
			2E	POLY
TS2	<input type="radio"/>	<input type="radio"/>	1C	PORT ON
			1D	PORT OFF
MS1	<input type="radio"/>	<input type="radio"/>	00	SINGLE
MS2	<input type="radio"/>	<input type="radio"/>	01	DUAL
MS3	<input type="radio"/>	<input type="radio"/>	02	SPLIT
MS4	<input type="radio"/>	<input type="radio"/>	03	SWAP
MS5	<input type="radio"/>	<input type="radio"/>	04	MIDI CH
FS1	<input type="radio"/>	<input type="radio"/>	18	SUSTAIN
FS2	<input type="radio"/>	<input type="radio"/>	1B	PORT
WHEEL1	<input type="radio"/>	<input type="radio"/>	10	P.B
WHEEL2	<input type="radio"/>	<input type="radio"/>	11	M.W
BREATH	<input type="radio"/>	<input type="radio"/>	12	B.C
AFTER	<input type="radio"/>	<input type="radio"/>	13	A.T
CS1	<input type="radio"/>	<input checked="" type="radio"/>	17	VOL A
CS2	<input checked="" type="radio"/>	<input type="radio"/>	17	VOL B
CS3	<input type="radio"/>	<input type="radio"/>	3A	LFS
CS4	<input type="radio"/>	<input type="radio"/>	15	PORT T.
FOOT1	<input type="radio"/>	<input type="radio"/>	17	VOLUME
FOOT2	<input type="radio"/>	<input type="radio"/>	14	F.C

Function ...	Transmitted	Received	Remarks
Basic Default	1 - 16 X	all channel	X memorized
Channel Changed	1 - 16	x	
Mode Default	3	x	
Mode Messages	OMNion,OMNIoff POLY,MONO	OMNion,OMNIoff POLY,MONO	
Note Number : True voice	1 - 127 XXXXXXXXXXXXXXXX	0 - 127	
Velocity Note ON	o 9nH, v=1-127	o	
Velocity Note OFF	x 9nH, v=0	o	
After Touch Key's	x	o	
After Touch Ch's	o	o	
Pitch Bender	o XX	o	XX 7 bit reso.
Control Change	0 - 121 o	o	
Prog Change : True #	o 0 - 127 XXXXXXXXXXXXXXXX	o 0 - 127	
System Exclusive	o XXX	o all	XXX Prm. change
System : Song Pos	x	o	
System : Song Sel	o 0 - 9	o	
Common : Tune	o	o	
System : Clock	o	o	
Real Time : Commands	o	o	
Aux : Local ON/OFF	o	o	
Aux : All Notes OFF	o	o	
Mes- : Active Sense	o	o	
sages:Reset	o	o	
Notes	Received messages are only bypassed to MIDI OUT.		

Mode 1 : OMNI ON, POLY
Mode 3 : OMNI OFF, POLY

Mode 2 : OMNI ON, MONO
Mode 4 : OMNI OFF, MONO

o : Yes
x : No

Function ...	Transmitted	Received	Remarks
Basic Default	1 - 16 X	all channel	X memorized
Channel Changed	1 - 16	x	
Mode Default	3	x	
Messages	OMNion, OMNIoff POLY, MONO	OMNion, OMNIoff POLY, MONO	
Note Number : True voice	1 - 127 XXXXXXXXXXXXXXXXXX	0 - 127	
Velocity Note ON	o 9nH, v=1-127	o	
Velocity Note OFF	x 9nH, v=0	o	
After Touch	Key's : x Ch's : o	o o	
Pitch Bender	o XX	o	XX 7 bit reso.
Control Change	0 - 121 : o	o	
Prog Change : True #	o 0 - 127 XXXXXXXXXXXXXXXXXX	o 0 - 127	
System Exclusive	o XXX	o all	XXX Prm. change
System : Song Pos	x	o	
System : Song Sel	o 0 - 9	o	
Common : Tune	o	o	
System : Clock	o	o	
Real Time : Commands	o	o	
Aux : Local ON/OFF	o	o	
Aux : All Notes OFF	o	o	
Mes- : Active Sense	o	o	
sages:Reset	o	o	
Notes	Received messages are only bypassed to MIDI OUT.		

Mode 1 : OMNI ON, POLY
 Mode 3 : OMNI OFF, POLY

Mode 2 : OMNI ON, MONO
 Mode 4 : OMNI OFF, MONO

o : Yes
 x : No

FCC INFORMATION (USA)

While the following statements are provided to comply with FCC Regulations in the United States, the corrective measures listed below are applicable worldwide.

This series of Yamaha professional music equipment uses frequencies that appear in the radio frequency range and if installed in the immediate proximity of some types of audio or video devices (within three meters), interference may occur. This series of Yamaha combo equipment have been type tested and found to comply with the specifications set for a class 8 computing device in accordance with those specifications listed in subpart J of part 15 of the FCC rules. These rules are designed to provide a reasonable measure of protection against such interference. However, this does not guarantee that interference will not occur. If your professional music equipment should be suspected of causing interference with other electronic devices, verification can be made by turning your combo equipment off and on. If the interference continues when your equipment is off, the equipment is not the source of interference. If your equipment does appear to be the source of the interference, you should try to correct the situation by using one or more of the following measures:

Relocate either the equipment or the electronic device that is being affected by the interference. Utilize power outlets for the professional music equipment and the device being affected that are on different branch (circuit breaker or fuse) circuits, or install AC line filters.

In the case of radio or TV interference, relocate the antenna or, if the antenna lead-in is 300 ohm ribbon lead, change the lead-in to the co-axial type cable.

If these corrective measures do not produce satisfactory results, please contact your authorized Yamaha professional products dealer for suggestions and/or corrective measures. If you cannot locate a franchised Yamaha professional products dealer in your general area contact the professional products Service Department, Yamaha International, 6600 Orangethorpe Ave., Buena Park, CA 90620, U.S.A.

If for any reason, you should need additional information relating to radio or TV interference, you may find a booklet prepared by the Federal Communications Commission helpful:

"How to Identify and Resolve Radio -- TV Interference Problems". This booklet is available from the U.S. Government Printing Office, Washington D.C. 20402--Stock No. 004-000-00345-4.

SERVICE

The KX88/76 are supported by Yamaha's worldwide network of factory trained and qualified dealer service personnel. In the event of a problem, contact your nearest Yamaha dealer.

YAMAHA

YAMAHA CORPORATION
10-1 Nakazawa-cho Hamamatsu 430 Japan
VD67960 8711 ① Printed in Japan