

FCC INFORMATION (U.S.A.)

1. IMPORTANT NOTICE: DO NOT MODIFY THIS UNIT!

This product, when installed as indicated in the instructions contained in this manual, meets FCC requirements. Modifications not expressly approved by Yamaha may void your authority, granted by the FCC, to use the product.

2. IMPORTANT: When connecting this product to accessories and/or another product use only high quality shielded cables. Cable/s supplied with this product **MUST** be used. Follow all installation instructions. Failure to follow instructions could void your FCC authorization to use this product in the USA.

3. NOTE: This product has been tested and found to comply with the requirements listed in FCC Regulations, Part 15 for Class "B" digital devices. Compliance with these requirements provides a reasonable level of assurance that your use of this product in a residential environment will not result in harmful interference with other electronic devices. This equipment generates/uses radio frequencies and, if not installed and used according to the instructions found in the users manual, may cause interference harmful to the operation of other electronic devices. Compliance with FCC regulations does not guarantee that interference will not occur in all installations. If this product is found to be the source of interference, which can be determined by turning the unit "OFF" and "ON", please try to eliminate the problem by using one of the following measures:

Relocate either this product or the device that is being affected by the interference.

Utilize power outlets that are on different branch (circuit breaker or fuse) circuits or install AC line filter/s.

In the case of radio or TV interference, relocate/reorient the antenna. If the antenna lead-in is 300 ohm ribbon lead, change the lead-in to co-axial type cable.

If these corrective measures do not produce satisfactory results, please contact the local retailer authorized to distribute this type of product. If you can not locate the appropriate retailer, please contact Yamaha Corporation of America, Electronic Service Division, 6600 Orangethorpe Ave, Buena Park, CA90620

The above statements apply **ONLY** to those products distributed by Yamaha Corporation of America or its subsidiaries.

* This applies only to products distributed by YAMAHA CORPORATION OF AMERICA.

PRECAUTIONS

PLEASE READ CAREFULLY BEFORE PROCEEDING

* Please keep these precautions in a safe place for future reference.

WARNING

Always follow the basic precautions listed below to avoid the possibility of serious injury or even death from electrical shock, short-circuiting, damages, fire or other hazards. These precautions include, but are not limited to, the following:

- Do not open the instrument or attempt to disassemble the internal parts or modify them in any way. The instrument contains no user-serviceable parts. If it should appear to be malfunctioning, discontinue use immediately and have it inspected by qualified Yamaha service personnel.
- Do not expose the instrument to rain, use it near water or in damp or wet conditions, or place containers on it containing liquids which might spill into any openings.
- If the AC adaptor cord or plug becomes frayed or damaged, or if there is a sudden loss of sound during use of the instrument, or if any unusual smells or smoke should appear to be caused by it, immediately turn off the power switch, disconnect the adaptor plug from the outlet, and have the instrument inspected by qualified Yamaha service personnel.
- Use the specified adaptor (PA-3B or an equivalent recommended by Yamaha) only. Using the wrong adaptor can result in damage to the instrument or overheating.
- Before cleaning the instrument, always remove the electric plug from the outlet. Never insert or remove an electric plug with wet hands.
- Check the electric plug periodically and remove any dirt or dust which may have accumulated on it.

CAUTION

Always follow the basic precautions listed below to avoid the possibility of physical injury to you or others, or damage to the instrument or other property. These precautions include, but are not limited to, the following:

- Do not place the AC adaptor cord near heat sources such as heaters or radiators, and do not excessively bend or otherwise damage the cord, place heavy objects on it, or place it in a position where anyone could walk on, trip over, or roll anything over it.
- When removing the electric plug from the instrument or an outlet, always hold the plug itself and not the cord.
- Do not connect the instrument to an electrical outlet using a multiple-connector. Doing so can result in lower sound quality, or possibly cause overheating in the outlet.
- Unplug the AC power adaptor when not using the instrument, or during electrical storms.
- Always make sure all batteries are inserted in conformity with the +/– polarity markings. Failure to do so might result in overheating, fire, or battery fluid leakage.
- Always replace all batteries at the same time. Do not use new batteries together with old ones. Also, do not mix battery types, such as alkaline batteries with manganese batteries, or batteries from different makers, or different types of batteries from the same maker, since this can cause overheating, fire, or battery fluid leakage.
- Do not dispose of batteries in fire.
- Do not attempt to recharge batteries that are not intended to be charged.

PRECAUTIONS

PLEASE READ CAREFULLY BEFORE PROCEEDING

* Please keep these precautions in a safe place for future reference.

CAUTION

Always follow the basic precautions listed below to avoid the possibility of physical injury to you or others, or damage to the instrument or other property. These precautions include, but are not limited to, the following:

- If the instrument is not to be in use for a long time, remove the batteries from it, in order to prevent possible fluid leakage from the battery.
- Keep batteries away from children.
- Before connecting the instrument to other electronic components, turn off the power for all components. Before turning the power on or off for all components, set all volume levels to minimum.
- Do not expose the instrument to excessive dust or vibrations, or extreme cold or heat (such as in direct sunlight, near a heater, or in a car during the day) to prevent the possibility of panel disfiguration or damage to the internal components.
- Do not use the instrument near other electrical products such as televisions, radios, or speakers, since this might cause interference which can affect proper operation of the other products.
- Do not place the instrument in an unstable position where it might accidentally fall over.
- Before moving the instrument, remove all connected adaptor and other cables.
- When cleaning the instrument, use a soft, dry cloth. Do not use paint thinners, solvents, cleaning fluids, or chemical-impregnated wiping cloths. Also, do not place vinyl or plastic objects on the instrument, since this might discolor the panel or keyboard.
- Do not rest your weight on, or place heavy objects on the instrument, and do not use excessive force on the buttons, switches or connectors.
- Do not operate the instrument for a long period of time at a high or uncomfortable volume level, since this can cause permanent hearing loss. If you experience any hearing loss or ringing in the ears, consult a physician.

Yamaha cannot be held responsible for damage caused by improper use or modifications to the instrument, or data that is lost or destroyed.

Always turn the power off when the instrument is not in use.

Make sure to discard used batteries according to local regulations.

Precautions

- Be sure to handle floppy disks and treat the disk drive with care. Follow the important precautions below.

Compatible Disk Type

- 3.5" 2DD and 2HD type floppy disks can be used. A blank 2HD floppy disk has been included with your instrument for you to record your performances.

■ Inserting/Ejecting Floppy Disks

To insert a floppy disk into the disk drive:

- Hold the disk so that the label of the disk is facing upward and the sliding shutter is facing forward, towards the disk slot. Carefully insert the disk into the slot, slowly pushing it all the way in until it clicks into place and the eject button pops out.

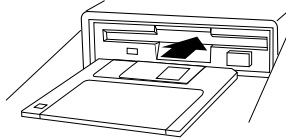

To eject a floppy disk:

- Before ejecting a floppy disk make sure that the floppy disk drive is not in operation (the DISK IN USE indicator should be off.)
- Press the eject button slowly as far as it will go; the disk will automatically pop out. When the disk is fully ejected, carefully remove it by hand.

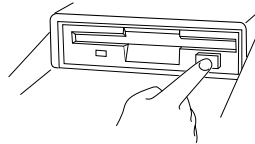

- Never attempt to remove the disk or turn the power off during recording, reading and playing back. Doing so can damage the disk and possibly the disk drive.
- If the eject button is pressed too quickly, or if it is not pressed in as far as it will go, the disk may not eject properly. The eject button may become stuck in a half-pressed position with the disk extending from the drive slot by only a few millimeters. If this happens, do not attempt to pull out the partially ejected disk, since using force in this situation can damage the disk drive mechanism or the floppy disk. To remove a partially ejected disk, try pressing the eject button once again, or push the disk back into the slot and then repeat the eject procedure.
- Be sure to remove the floppy disk from the disk drive before turning off the power. A floppy disk left in the drive for extended periods can easily pick up dust and dirt that can cause data read and write errors.

Cleaning the Disk Drive Read/Write Head

- Clean the read/write head regularly. This instrument employs a precision magnetic read/write head which, after an extended period of use, will pick up a layer of magnetic particles from the disks used that will eventually cause read and write errors.
- To maintain the disk drive in optimum working order Yamaha recommends that you use a commercially-available dry-type head cleaning disk to clean the head about once a month. Ask your Yamaha dealer about the availability of proper head-cleaning disks.

Never insert anything but floppy disks into the disk drive. Other objects may cause damage to the disk drive or floppy disks.

■ About the Floppy Disks

To handle floppy disks with care:

- Do not place heavy objects on a disk or bend or apply pressure to the disk in any way. Always keep floppy disks in their protective cases when they are not in use.
- Do not expose the disk to direct sunlight, extremely high or low temperatures, or excessive humidity, dust or liquids.
- Do not open the sliding shutter and touch the exposed surface of the floppy disk inside.
- Do not expose the disk to magnetic fields, such as those produced by televisions, speakers, motors, etc., since magnetic fields can partially or completely erase data on the disk, rendering it unreadable.
- Never use a floppy disk with a deformed shutter or housing.
- Do not attach anything other than the provided labels to a floppy disk. Also make sure that labels are attached in the proper location.

To protect your data (Write-protect Tab):

- To prevent accidental erasure of important data, slide the disk's write-protect tab to the "protect" position (tab open).

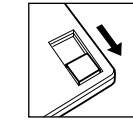
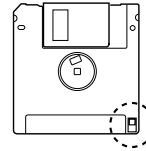

Write protected

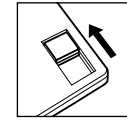

Write enabled

Data backup

- For maximum data security Yamaha recommends that you keep two copies of important data on separate floppy disks. This gives you a backup if one disk is lost or damaged. To make a backup disk use the Backup function on page 54.

YAMAHA is not responsible for damage caused by improper handling or operation.
YAMAHA provides no guarantee against disk damage.

- * Apple and Macintosh are the registered trademarks of Apple Computer, Incorporated.*
- * Atari is the registered trademark of Atari Corporation.*
- * IBM PC/AT is the registered trademark of International Business Machines Corporation.*
- * MS-DOS is the registered trademark of Microsoft Corporation.*
- * The company names and product names in this owner's manual are the trademarks or registered trademarks of their respective companies.*

CONGRATULATIONS!

You are now the proud owner of a Yamaha MDF3 MIDI Data Filer. This compact data storage unit is capable of storing bulk data from nearly any MIDI-equipped synthesizer, tone generator, or sequencer on convenient 3.5" 2HD/2DD floppy disks. The MDF3 is also able to record and play back sequencer data in realtime, a feature which makes it handy for use as a portable sequencer.

To put the MDF3 to work, you will need to connect it to at least one other MIDI device. If you own the Yamaha QX3 or a MIDI-equipped personal computer with a 3.5" disk drive, the MDF3 will also be able to read the data from disks you create with these devices, for maximum flexibility and convenience in data management.

This Owner's Manual has been written for easy reference, and includes helpful advice for a wide range of applications. In order to take full advantage of the many capabilities of your MDF3, we urge you to read through the manual carefully first, then keep it on hand for future reference.

FEATURES

- **MIDI data recorder capability**

The MDF3 is able to receive, store, and re-transmit MIDI System Exclusive data from nearly any MIDI instrument with bulk data transmission capability, including devices made by manufacturers other than Yamaha. The MDF3 can also read and transmit bulk data files created by the Yamaha MDF2 Data Filer and the QX3 sequencer in that device's MDR mode.

- **Sequencer capability**

The MDF3 is capable of recording sequence data to disk, and playing back this data in realtime. It can also play back data files written by other MIDI devices using Standard MIDI File format 0/1, as well as ESEQ sequence files created by

the Yamaha QX3, etc. (You can also play back the MDF2's SEQ data). Other convenient playback functions allow you to play a program of up to 99 sequence data files in a specified order, and to play back files repeatedly in an endless loop.

- **Ample data storage capacity**

The MDF3 can store as many as 99 bulk or sequence files — on each 2HD/2DD floppy disk. If necessary, a single bulk or sequence data file can occupy the disk's total capacity of roughly 1,200/600 kilobytes of data. In sequencer mode, this corresponds to approximately 150,000/75,000 notes' worth of sequence data.

ABOUT THIS MANUAL

This Owner's Manual introduces the MDF3's functions in an order close to that in which you are most likely to be using them. As you read through the manual, you will soon learn how the MDF3 works; and you will find, in addition, a number of hints on how you can put its features to use.

Nearly every operation in this manual is described as a series of simple steps, often including diagrams that make the procedure easy to follow. Supplementary information about the operation will be preceded by the words "Note", "Hint", or "Caution". Hints and notes serve as clues to details about the operation that you will not want to overlook.

For further information regarding the operation of the MDF3, you can refer to the following sections:

■ ***MDF3 Mode Overview (page 20)***

This map summarizes the MDF3's major functions, and serves as a convenient guide to common operations.

■ ***What Error Messages Tell You (page 63)***

If an error message appears in the LCD while you are using the MDF3, refer to this appendix for an explanation of the problem and advice on how to solve it.

This manual is accompanied by the following supplementary documentation:

■ ***MIDI Implementation Chart***

This chart summarizes the MDF3's MIDI capabilities, and helps you to determine whether the MDF3 is compatible with the other equipment you are using.

■ ***MIDI Data Format***

Advanced MIDI users who do their own programming will want to refer to this document for a detailed description of the MIDI Data Formats used by the MDF3.

TABLE OF CONTENTS

ABOUT THIS MANUAL	8	Selecting a MIDI Sync Mode	44
BASIC TERMS AND KEYWORDS	10	Enabling MIDI Control Messages	45
INTRODUCING THE MDF3	12	Notes on MIDI Synchronization	46
PREPARING TO USE THE MDF3	14	UTILITY MODE	47
Supplying Power	14	File Names in UTILITY Mode	48
Connecting a MIDI Device	15	Renaming Files	49
Turning the Power On	15	Deleting Files	51
Formatting a Floppy Disk	16	Copying or Appending Files	52
Handling Floppy Disks	18	Copying Disks	54
Protecting the data on a disk	19	Formatting Disks	56
MDF3 MODE OVERVIEW	20	Displaying Disk Information	57
MDR MODE	23	THE STANDARD MIDI FILE AND ESEQ FORMATS	58
Receiving Bulk Data	24	ADVANCED FILE MANAGEMENT TECHNIQUES	59
Transmitting Bulk Data	27	Reading MDF3 Disks with a Computer	59
Notes on MDR Data Reception and Transmission	29	Changing MDF3 File Name Extensions	60
SEQ MODE	31	APPLICATIONS	62
Recording Sequence Data	32	A Portable MIDI Playback System	62
Playing Back Sequence Data	35	An Extended MIDI System	62
Notes on SEQ Data Recording and Playback	38	WHAT ERROR MESSAGES TELL YOU	63
JOB MODE	39	ABOUT THE MIDI IMPLEMENTATION CHART	65
Repeating Playback	40	SPECIFICATIONS	66
Creating a Playback Program	41	INDEX	67
Changing the Record Tempo	43		

MIDI-related terminology

Here we define several basic terms used in this manual. These terms are frequently used in describing the functions of MIDI equipment.

MIDI

An abbreviation for Musical Instrument Digital Interface, which is the name of an international standard providing for the communication of data between electronic musical instruments. MIDI allows musical instruments such as synthesizers and drum machines to communicate with each other, and to be controlled by sequencers or computers.

MIDI device

Any piece of electronic equipment capable of receiving or sending data in a manner that complies with the MIDI standard. This term is often applied to synthesizers, tone generators, rhythm machines, and sequencers; however, it also includes a variety of peripheral devices including signal processors and patch bays, not to mention MIDI data recorders such as the MDF3.

MIDI data

Data in a format that complies with the MIDI standard. MIDI data can be divided between two broad categories : sequence data and bulk data.

sequence data

The data used to record and play back music. Generally speaking, sequence data consists of note on and off messages, control change messages, and program change messages. In special cases, however, it may also include certain types of system exclusive data.

bulk data

Data transmitted in units known as blocks, usually for the purpose of storage or retrieval. Each MIDI device usually transmits bulk data in a unique format that distinguishes it from the bulk data of other devices; thus, it is also known by the name “system exclusive data”. Bulk data is usually not directly related to a musical performance; rather, it is used as a means for transferring large blocks of data, such as voice data, samples, or system setup data, between two MIDI devices.

bulk dump

A transmission of bulk data from one MIDI device to another.

Keywords for MDF3 operation

The terms defined below are used throughout the manual to describe functions peculiar to the MDF3. The same words are frequently used in describing other MIDI devices, as well; but keep in mind that in many cases the actual function in question may differ considerably from that performed by the MDF3.

file	A position on a disk where data is stored and assigned a name. The MDF3 is capable of managing up to 99 files on a single disk. The number of files that can be created on any given disk is physically limited by the size of the files and the disk's capacity of approximately 1,200 (MF2HD)/600 (MF2DD) kilobytes.	file , it simultaneously reads data from the disk and outputs it via the MIDI OUT jack.
MDR mode	The mode of operation in which the MDF3 is used to receive and transmit MIDI bulk data.	SEQ mode The mode of operation in which the MDF3 is used to record and play back sequence data.
MDR data	The contents of the data file that is created when the MDF3 receives bulk data from another MIDI device.	SEQ data The contents of the file that is created when the MDF3 records sequence data. Such data is often referred to as "song data". Strictly speaking, however, such a file can contain as many as several songs, or as little as a single phrase.
reception	Generally, the receiving by one MIDI device of MIDI data from another. In this manual, "reception" refers specifically to the MDF3's reception of bulk data. The MDF3 automatically writes the bulk data it receives to disk as an MDR data file.	recording The reception of MIDI sequence data. Recording is different from the reception of bulk data in that the data is received in realtime. The MDF3 automatically writes the sequence data it receives to disk as a SEQ data file.
transmission	Generally speaking, the sending of data from one MIDI device to another. In this manual, "transmission" means specifically the transmission of MDR data by the MDF3. When the MDF3 transmits the contents of an MDR data	playback The transmission of sequence data from one MIDI device to another. Playback differs from the transmission of bulk data in that the sequence data is transmitted in realtime. When the MDF3 plays back a SEQ data file, it simultaneously reads data from the disk and outputs it via the MIDI OUT jack.

INTRODUCING THE MDF3

Front panel

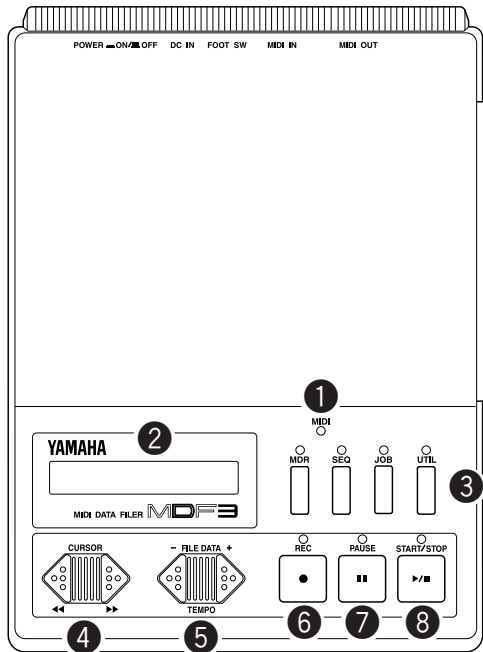

- 1 MIDI LED** This LED lights when the MDF3 is receiving MIDI data. Note that it does not light when data is being transmitted, however.

2 LCD

The LCD displays a variety of information to assist you in operating the MDF3.

3 Mode keys

These keys allow you to switch between the MDF3's four operating modes. The MDF3's modes — MDR mode, SEQ mode, JOB mode, and UTILITY mode — are outlined in the MDF3 Mode Overview on page 20.

4 CURSOR keys

These keys move the cursor in the LCD to the left or right. They can also be used to fast forward or rewind a file during playback in SEQ mode.

5 FILE DATA keys

These keys are used to select a file (in the MDR and SEQ modes) or a function (in the JOB and UTILITY modes). They can also be used to change the tempo during playback in SEQ mode.

6 REC key

This key is used in combination with the **START/STOP** key to begin the reception/recording of data in MDR and SEQ modes.

7 PAUSE key

This key pauses the recording or playback of a file in progress in SEQ mode. It can also be used in combination with the **REC** key to tell the MDF3 to standby for recording in this mode.

8 START/STOP key

This key is used to start and stop reception/recording or transmission/playback in MDR and SEQ modes. It is also used to execute functions in the JOB and UTILITY modes.

Rear Panel

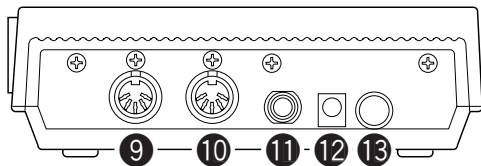

- 9 MIDI OUT** This jack outputs MIDI data.
- 10 MIDI IN** Received MIDI data is input via this jack.
- 11 FOOT SW** This jack enables START/STOP control by pressing the foot switch (optional Yamaha FC4, FC5, etc.) if it is connected.
- 12 DC IN** The DC plug of an optional AC power adapter (Yamaha PA-3B) can be connected here.
- 13 POWER** This switch turns the power to the MDF3 on and off.

Side Panel

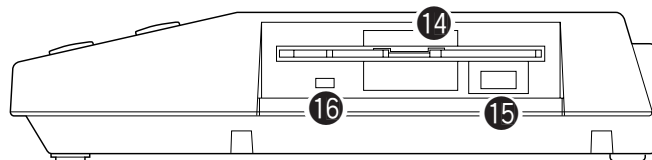

- 14 Disk Drive** This 3.5" disk drive is capable of accepting both 2HD and 2DD floppy disks.
- 15 Eject button** This button ejects the floppy disk from the disk drive.
- 16 Disk Access LED** This LED lights when data is being written to or read from a disk. Never attempt to remove a disk from the disk drive while this lamp is lit.

PREPARING TO USE THE MDF3

Supplying Power

Using an Optional AC adaptor

If you use the MDF3 often, you will probably want to power it with an AC power adaptor. The MDF3 can be powered by the Yamaha PA-3B power adaptor, which is available for purchase separately.

Before you connect the adaptor, check to make sure that the POWER switch on the rear panel is turned off.

Plug the round end of the adaptor cord into the DC IN jack on the back panel of the MDF3, then plug the adaptor itself into an AC outlet.

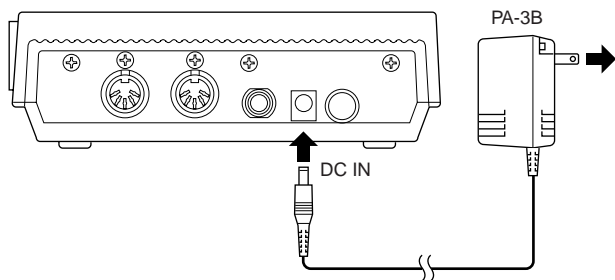

Caution: Be sure to use a power adaptor that is suited to the voltage in your locale. Do not use an adaptor other than PA-3B. Any other AC adaptor using different voltage can damage the MDF3.

Unplug the AC power adaptor when not using the instrument, or during electrical storms.

Using Batteries

Under normal operating conditions, the MDF3 can be operated continuously for approximately three hours using a fresh set of batteries.

Before you begin to insert the batteries, check to make sure that the POWER switch on the rear panel is turned off. Then, place six size “AA” alkaline batteries in the battery compartment located on the underside of the unit.

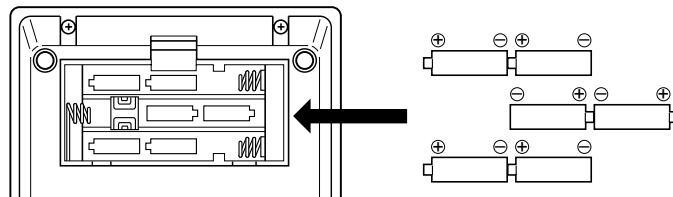

Make sure that the batteries are oriented properly. The correct orientation is indicated by the markings on the inside of the compartment.

Caution: When the batteries run down, replace them with a complete set of six new batteries. NEVER mix old and new batteries.

Do not use different types of batteries (e.g. alkaline and manganese) at the same time.

Be sure to remove the batteries from the MDF3 when you will not be using it for an extended period of time. If you leave batteries in the unit during extended periods of disuse, you run the risk of damage due to corrosion.

Connecting a MIDI Device

You need only one MIDI cable to connect the MDF3 to another MIDI device.

When you will be using the MDF3 to receive or record data, plug one end of the cable into the MIDI IN jack on the MDF3 back panel, and the other end into the MIDI OUT jack of the other device.

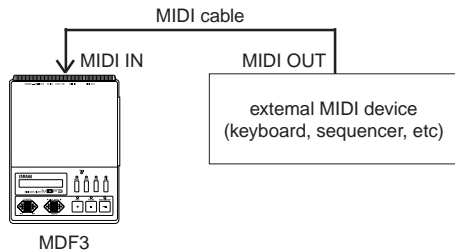

To transmit or play back data from the MDF3, simply reverse these connections.

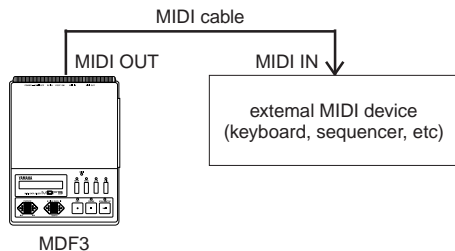

If you have two MIDI cables, you can connect the MIDI IN jack of each device to the MIDI OUT jack of the other. This convenient arrangement will allow you to avoid the repeated changing of MIDI cable connections.

Turning the Power On

To turn on the MDF3, simply press the POWER switch on the rear panel.

The message "YAMAHA MDF3" will appear in the LCD for a few moments. Then, if there is no disk in the disk drive, this message will be replaced by the following display:

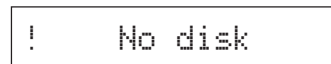

Insert the 3.5" 2HD/2DD floppy disk that came with your MDF3 in the disk drive. Be sure to insert the disk with the label side facing up and the arrow pointing toward the disk drive.

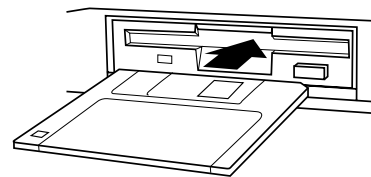

Push the disk in gently, until you hear it settle into the drive with a click.

Note: The MDF3 is capable of using 3.5" 2HD/2DD floppy disks. Please do not try to use any other type of disk.

Formatting a Floppy Disk

Before the MDF3 can create files on a new disk, it must prepare the disk to accept the data using a procedure known as “formatting”. Follow the steps below to format the floppy disk that came with your MDF3.

1. Enter the UTILITY mode.

Press the **UTIL** key. The LED above the key will light.

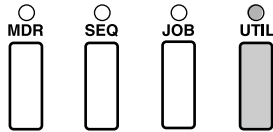

2. Select “05: Format”

Press the **FILE DATA [+]** key four times. The following message will appear in the LCD.

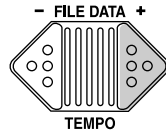

3. Press the START/STOP key.

The LED above the key will flash, and the following message will appear in the LCD:

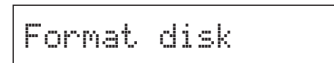
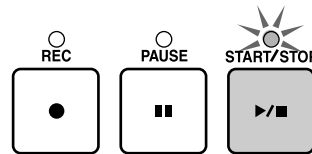

4. Insert a disk.

If you have not already done so, insert the 2HD/2DD disk to be formatted in the disk drive.

Note: If you format a disk that has been used before, any data it contains will be erased. Make absolutely sure that a disk does not contain any important data before you format it.

5. Press the START/STOP key.

The LED above the key will light steadily, and the LCD will display a message telling you what percentage of the disk has been formatted.

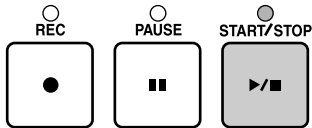

Formatting 93%

6. Format another disk.

If you wish to format another disk at this point, eject the disk and insert a new one. Then press the **START/STOP** key to begin formatting once more.

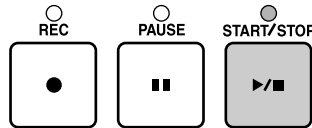

7. Exit the function.

When you're done formatting disks, press any mode key (**MDR**, **SEQ**, **JOB**, or **UTIL**) to exit the "Format" function.

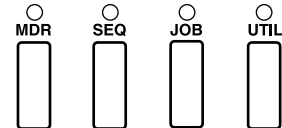

It should take approximately 70 seconds to format a single floppy disk. When the disk has been completely formatted, the START/STOP LED will begin to flash again, and the "Format disk" message will reappear.

Handling Floppy Disks

The 3.5" 2HD/2DD floppy disk is a reliable and convenient medium for data storage, capable of holding large amounts of data in a small package. The disk itself is a delicate piece of magnetic film, which is protected from dust and dirt by a hard plastic cover and a shutter. This design is capable of preserving your data against most contingencies. However, for the greatest reliability, you should observe a few basic cautions when handling your disks.

- Use 2HD/2DD disks. The MDF3 is not designed to handle disks meeting other specifications.
- Never remove a disk from the disk drive while the disk access LED is lit. Doing so can damage the floppy disk or the disk drive.
- Avoid touching the shutter of a disk. Never open the shutter and touch the actual disk surface.
- Avoid placing disks close to speakers, televisions, magnets, or other objects with magnetic fields. Even weak magnetic fields can damage or erase the data on a disk.
- Do not leave your disks in cars or other locations where they may be exposed to extreme heat or cold.
- Do not leave your disks in places where they may be exposed to condensation or extremely high humidity.
- Avoid using or storing disks in places where they may be exposed to large amounts of dust or dirt.

Follow these cautions scrupulously. Improper handling can render a disk useless, and may cause damage to the MDF3's disk drive as well.

Protecting the data on a disk

If you turn a disk face down, you will find a small plastic tab in the lower right corner. This tab is a write-protect switch that you can use to prevent the accidental loss of valuable data. When this tab is in the up position (so the window is closed), the MDF3 will be able to read and write data to the disk normally.

To protect the data on a disk, push the tab down so that the window is open. The MDF3 will be able to read the data on the disk as usual. However, if you try to receive or record data using the disk, the MDF3 will display an error message telling you that the disk is write-protected.

You will see the same message if you try to format a write-protected disk or change the data it contains using one of the UTILITY mode functions.

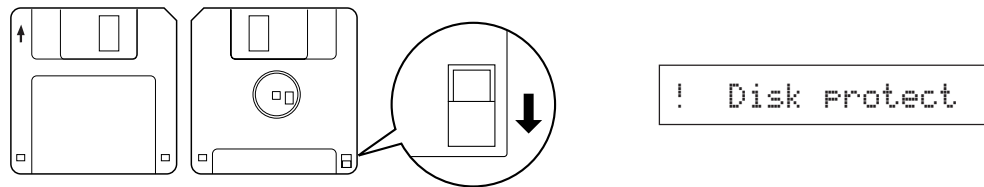

Note: To protect disks against accidental erasure, it is a good idea to set the protect tab down and keep the disk in a safe place. You also might consider making a backup copy of the disk using the UTILITY mode "Backup" function. Finally, clear labeling of disk contents is a simple but effective way to prevent the accidental loss of valuable data.

MDF3 MODE OVERVIEW

Now that you've formatted a floppy disk, you're ready to start using the MDF3. The overview below summarizes the use of each of the MDF3's four modes, and shows you how to access the JOB and UTILITY mode functions.

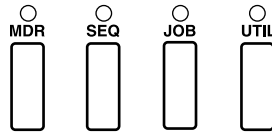

MDR mode (page 23)

This mode lets you receive bulk data from a MIDI device and save it to disk as an MDR data file. In this mode the MDF3 can also transmit the contents of MDR files it creates, as well as bulk data files created by the Yamaha MDF2 and the QX3 in MDR mode.

SEQ mode (page 31)

This mode lets you record sequence data as standard MIDI files. In this mode, the MDF3 can also play back the SEQ data files it creates (You can also play back the MDF2's SEQ data files), as well as Yamaha ESEQ data files and standard MIDI files created by other devices.

JOB mode (page 39)

This mode lets you play back SEQ data files repeatedly, or in a programmed order. It also allows you to set the sequence data playback tempo, and to enable or disable the transmission and reception of MIDI sync and system control messages.

UTILITY mode (page 47)

The UTILITY mode lets you rename, delete, copy, and append files. It also allows you to format or copy disks, and to check the amount of space remaining on a disk.

Hint: In the JOB and UTILITY modes, you can use the **FILE DATA** keys to select a function, and the **START/STOP** key to execute the function you've selected.

JOB mode functions



01: Repeat Play

This function lets you repeatedly play back one or more SEQ data files in an endless loop. (page 40)

02: Prog Play

This function lets you create a program of SEQ data files to be played back in a specified order. (page 41)

03: Record tempo

This function allows you to change the playback tempo that is recorded for a sequence data file. (page 43)

04: Sync mode

This function determines whether the MDF3 runs on its internal clock, or in sync with an external MIDI clock. (page 44)

05: MIDI control

This function enables or disables the transmission and reception of MIDI realtime control messages (i.e., START, CONTINUE, and STOP messages), as well as the transmission of MIDI clock signals. (page 45)



UTILITY mode functions



01: Rename

This function lets you change the names of MDR or SEQ data files which have been saved to disk. (page 49)

02: Delete

This function lets you delete unneeded MDR or SEQ data files from a disk. (page 51)

03: Append

This function creates a copy of a file, or appends the data of one file to the end of another file. (page 52)

04: Backup

This function lets you copy the entire contents of one disk to another disk. (page 54)

05: Format

This function is used to format new floppy disks for use by the MDF3. (page 56)

06: Disk info.

This function displays information about a disk, including the amount of disk space that has been used, the amount of available space remaining, the number of files that have been used, and their respective sizes. (page 57)



MDR MODE

In its MIDI data recorder (MDR) mode, the MDF3 is capable of receiving MIDI bulk data from nearly any MIDI device and saving it to disk as an MDR data file. It can then transmit this data back to the device that originated it, or to any other device capable of accepting the data, at any time.

Receiving bulk data

The bulk data reception function is used to receive bulk data sent from another MIDI device. The MDF3 automatically writes the bulk data it receives to disk as an MDR data file using Standard MIDI File format 0. You can save up to 99 MDR data files on a single disk.

Transmitting bulk data

The bulk data transmission function lets the MDF3 output the data which it has previously saved as an MDR data file to a MIDI device capable of receiving it. The MDF3 is also able to transmit the data from files created by the Yamaha MDF2 and the QX3 in that device's MDR mode.

Receiving Bulk Data

1. Check your MIDI connections.

The MIDI IN jack of the MDF3 should be connected to the MIDI OUT jack of the sending device.

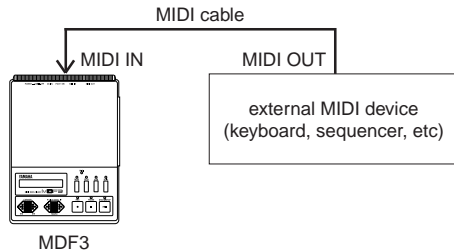

If you have not done so already, place a formatted disk in the MDF3 disk drive.

2. Enter MDR mode.

Press the **MDR** key. The LED above the key will light, and the name of the currently selected MDR data file will appear in the LCD.

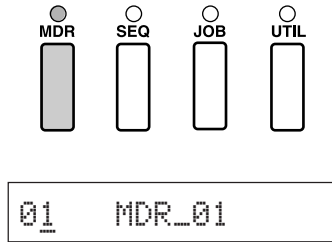

3. Select an empty file.

Using the **FILE DATA** keys, select the number of the empty file where you want to save the data. (The names of empty files will be blank.)

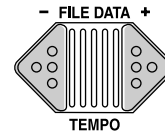

Note: If you select a file which already contains data, that data will be erased when the incoming data is received. If you choose such a file, make sure it does not contain data that you want to keep.

4. Prepare the MDF3 for reception.

While pressing the **REC** key, press the **START/STOP** key.

The LEDs above these keys will light, and the following display will appear in the LCD.

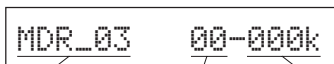
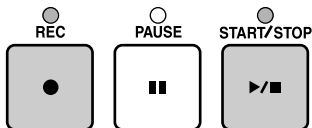

default file name current block number total data received (kilobytes)

This display indicates that the MDF3 is ready to begin receiving block data.

5. Send the bulk data.

Execute the sending device's bulk dump procedure to begin sending data. Refer to the appropriate operation manual for a description of the correct procedure.

As soon as the MDF3 begins receiving data, the MIDI LED will light and the display will begin changing to indicate the amount of data received.

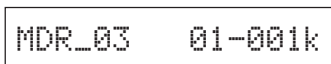

The MIDI LED will go out when all of the bulk data has been received.

Hint: To stop reception temporarily, press the **PAUSE** key. The LED above the key will blink, and the MDF3 will complete the reception of the current data block. Once the block has been received, the **PAUSE** key LED will light steadily to indicate that the MDF3 has paused. Pressing the **PAUSE** key again or pressing the foot switch (if connected) will cause the MDF3 to resume reception.

You can cancel reception immediately by pressing the **START/STOP** key. If you do so, the MDF3 will not create an MDR data file.

6. Send additional data, if any.

You can create MDR data files containing two or more sets of bulk data by executing consecutive bulk dumps. Just repeat step 5 as needed. All of the data you send will be recorded in sequence to the file you selected in step 3.

7. End MDF3 reception.

When you've finished sending data to the MDF3, make sure that all the data you sent has been received, then press the **START/STOP** key.



The data you sent will be saved to the MDR data file you selected, using the default file name "MDR_" followed by the file number.

Hint: This technique can be used to store multiple data sets for a single MIDI device. In more complex MIDI systems, you can use the same technique to store data (e.g., the settings you will use during a live performance) for a number of different devices.

Hint: If you would like to give the file another name, you can do so using the "Rename" function (page 49)

Transmitting Bulk Data

1. Check your MIDI connectoins.

The MIDI OUT jack of the MDF3 should be connected to the MIDI IN jack of the receiving device.

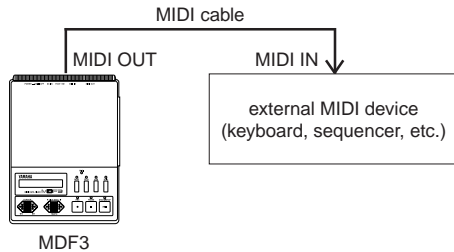

If you have not done already, place a disk containing the bulk data in the MDF3 disk drive.

2. Enter MDR mode.

Press the **MDR** key. The LED above the key will light, and the name of the currently selected MDR data file will appear in the LCD.

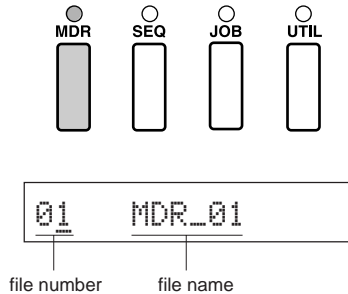

3. Select a file to transmit.

Using the **FILE DATA** keys, select the file to be transmitted.

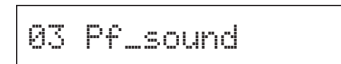
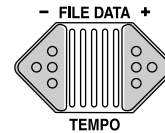

4. Prepare the receiving device.

Prepare the receiving device to receive the bulk data. The preparations to be made vary from device to device. Refer to the appropriate operation manual to check the correct procedure.

5. Transmit the MDR data.

Press the **START/STOP** key to begin transmitting. While the bulk data is being transmitted, the LCD will display the amount of data that has been sent.

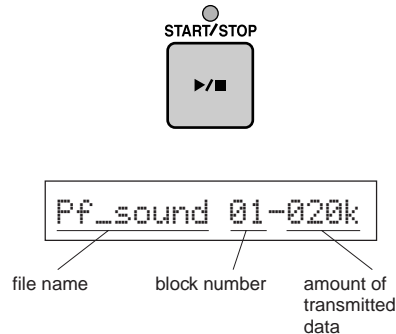

The file selection display will reappear when the transmission of MDR data is complete.

Hint: To stop transmission temporarily, press the **PAUSE** key. The LED above the key will blink, and the MDF3 will complete its transmission of the current data block. Once the block has been transmitted, the **PAUSE** key LED will light steadily to indicate that the MDF3 has paused. The MDF3 will resume transmission when you press the **PAUSE** key again or press the foot switch if it is connected.

You can cancel transmission by pressing the **START/STOP** key. The MDF3 will end transmission after it has sent the current data block.

Notes on MDR Data Reception and Transmission

Reception

MDR file size: On a newly formatted 2HD disk, a single MDR data file can hold up to about 1,200 kilobytes of data. When using a disk that already contains several files, check the amount of available space on the disk (page 57) before you try to receive the bulk data.

Bulk data blocks: The MDF3 recognizes bulk data blocks by their header (System Exclusive status: F0H) and footer (End of Exclusive: F7H) values.

Block intervals: When the MDF3 creates MDR files, it also records timing data at 10 millisecond intervals. If the interval between any two data blocks exceeds one second, the MDF3 will record it as one second. When receiving data from a MIDI device that will require intervals greater than one second between blocks when you attempt to transmit the data back to the device, record the bulk data in SEQ mode. (Refer to “Recording bulk data” on page 38)

Transmission

MDR file formats: In addition to its own files, the MDF3 is capable of transmitting bulk data files which other devices save to disk using Standard MIDI File format 0. Moreover, it can transmit MDR bulk data files written by the Yamaha MDF2 and the QX3 in that device’s MDR mode. It distinguishes between these two types of files by checking the header of each file before it begins transmitting the data in the file.

Transmitting QX3 data: When the MDF3 transmits MDR data files written to a disk by the QX3, it will automatically insert a 100 millisecond interval after every data block, as well as after each kilobyte of data (when a block is longer than one kilobyte).

The following descriptions of the sequence data recording and playback procedures assume that you will be recording data output by a MIDI keyboard. Of course, you can use the same procedures to record sequence data played back by a sequencer, a personal computer, or the like.

Recording Sequence Data

When you record data in SEQ mode, the MDF3 automatically writes this data to disk as a SEQ data file using Standard MIDI File format 0. You can save up to 99 SEQ data files on a single disk.

Playing Back Sequence Data

The MDF3 can of course play back the files it records in SEQ mode. It can also play back files written by other devices using Standard MIDI File format 0 or 1, as well as sequence files written in the ESEQ format used by the QX3 and other Yamaha devices. You can also play back the MDF2's SEQ data files.

Note: *If you will be using the MDF3 to play sequence files written by other devices, be sure to keep these files and your SEQ files on separate disks. If you mix SEQ files with other sequence files on a single disk, the MDF3 will display the names of only the SEQ files. (Please see "The Standard MIDI File and ESEQ Formats" on page 58 for details.)*

Recording Sequence Data

1. Check your MIDI connections.

The MIDI IN jack of the MDF3 should be connected to the MIDI OUT jack of the sending device.

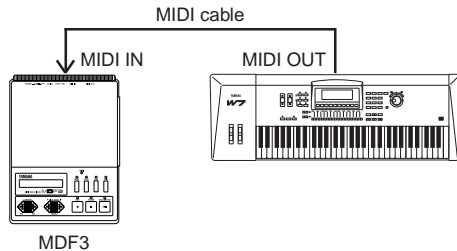

If you have not done so already, place a formatted disk in the MDF3 disk drive.

2. Enter SEQ mode.

Press the **SEQ** key. The LED above the key will light, and the name of the currently selected SEQ data file will appear in the LCD.

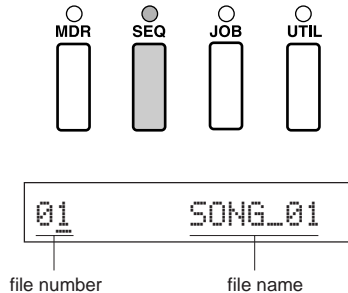

3. Select an empty file.

Using the **FILE DATA** keys, select the number of the empty file where you want to record the data. (The names of empty files will be blank.)

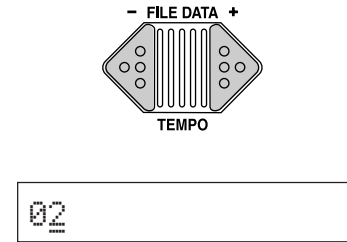

Note: If you select a file which already contains data, that data will be erased when the incoming data is received. If you choose such a file, make sure it does not contain data that you want to keep.

4. Prepare the MDF3 for recording.

While pressing the **REC** key, press the **PAUSE** key.

The LEDs above the **REC**, **PAUSE**, and **START/STOP** keys will light, and the following display will appear in the LCD.

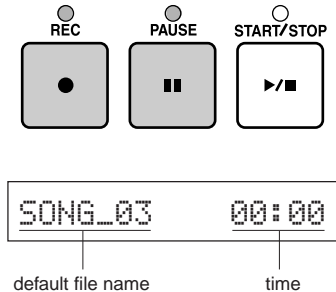

The MDF3 is now in record standby mode.

Hint: If you prefer, you can press the **START/STOP** key instead of the **PAUSE** key to begin recording immediately.

5. Start playing.

Begin playing music on your MIDI keyboard. As soon as the MDF3 receives MIDI data from the keyboard, it will cancel the pause and start recording the data.

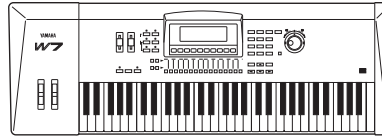

Hint: To pause during recording, simply press the **PAUSE** key. The MDF3 will begin recording again as soon as it receives any MIDI data (except bulk data), or if you press the **PAUSE** key once more. You can also resume recording by pressing the foot switch if it is connected.

If you press the **START/STOP** key while the recording is paused, the recording will end and the data up to that point will be saved as a SEQ file.

6. End the recording.

When you have finished recording data, press the **START/STOP** key again.

The data you sent will be saved to the SEQ data file you selected, using the default file name "SONG_" followed by the file number.



03 SONG_03

Hint: If you would like to give the file another name, you can do so using the "Rename" function (page 49).

Playing Back Sequence Data

1. Check your MIDI connections.

The MIDI OUT jack of the MDF3 should be connected to the MIDI IN jack of the receiving device.

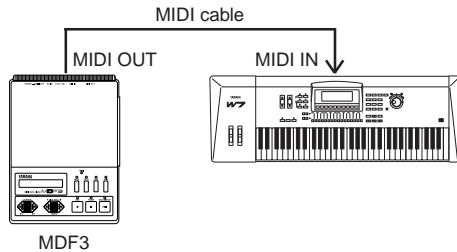

If you have not done so already, place a disk containing the sequence data in the MDF3 disk drive.

2. Enter SEQ mode.

Press the **SEQ** key. The LED above the key will light, and the name of the currently selected SEQ data file will appear in the LCD.

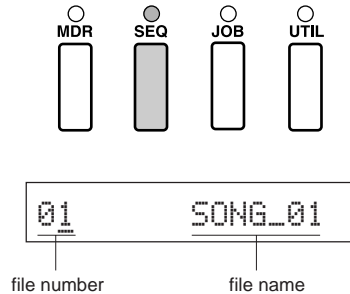

3. Select a file to transmit.

Using the **FILE DATA** keys, select the file to be played back.

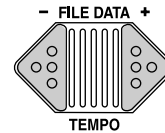

4. Prepare the receiving device.

Prepare your keyboard or tone generator to receive the sequence data. The preparations to be made vary depending on the instrument, but may include the selection of MIDI channels and sound programs, the adjustment of pitch bend and modulation ranges, and so on. Refer to the appropriate operation manual to check the correct procedure.

5. Start the playback.

Press the **START/STOP** key. The MDF3 will begin to play back the sequence data file you've selected. While the file is playing, the LCD will indicate the elapsed performance time.

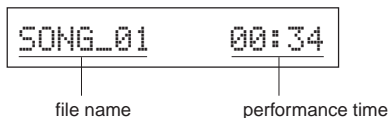

Note: When you press the **START/STOP** key, the MDF3 will hesitate for 1 – 15 seconds as it reads data from the disk before it begins to play back the data. If you need to start the playback with greater accuracy, press the **PAUSE** key immediately after pressing the **START/STOP** key and wait until the **START/STOP** LED lights. The MDF3 will begin playing the file as soon as you press the **PAUSE** key a second time or press the foot switch if it is connected.

6. Change the tempo.

You can use the **FILE DATA** keys to change the playback tempo while the file is playing. When you press one of the **FILE DATA** keys, the following display will appear.

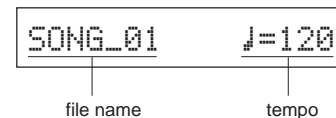
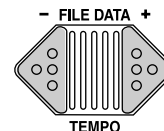

Note: Sequence data files created by devices other than the MDF3 may include tempo change data that will alter the tempo regardless of the changes you make using the **FILE DATA** keys. Since the playback tempo is commonly recorded at the beginning of a file, you may find that the tempo will return to its original value if you play a file from the top after changing the tempo using the **FILE DATA** keys.

7. Advance, rewind, or pause the file.

While the file is playing, you can use the **CURSOR** keys to fast forward or rewind the file. Also, you can press the **PAUSE** key to pause the playback temporarily.

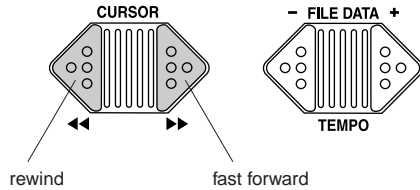

8. Stop the playback.

Playback will stop automatically when the MDF3 reaches the end of the file. If you want to stop the playback before the MDF3 comes to the end of the file, simply press the **START/STOP** key.



When playback ends, the name of the currently selected file will appear.

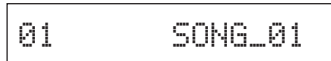

Hint: Files can be played back repeatedly using the “Repeat play” function (page 40). If a disk contains more than one SEQ data file, the files can be played back in a specified order using the “Prog play” function (page 41).

Notes on SEQ Data Recording and Playback

Recording

Record tempo: A default playback tempo of 120 beats per minute is recorded for each SEQ data file. You can change the tempo before you begin recording using the Record Tempo function (page 43).

Recording bulk data: Since the MDF3 records both bulk and sequence data as standard MIDI files, it is able to record bulk data as well as sequence data in SEQ mode. To record bulk data in SEQ mode, you must start the recording using the **REC** and **START/STOP** keys, rather than the **REC** and **PAUSE** keys. Also, if you pause the recording while the MIDI LED indicates that the MDF3 is receiving data, the **PAUSE** key will blink and the MDF3 will continue recording until it has finished receiving the current block. Finally, you must press the **START/STOP** key to stop recording manually. Otherwise, the MDF3 will continue recording even after the sending device has stopped sending data.

Playback

SEQ file formats: In addition to its own SEQ files, the MDF3 is capable of playing back sequence data files which other devices have written to disk using Standard MIDI File format 0 or 1, a format which is supported by a broad range of computer-based MIDI software. It is also capable of playing back ESEQ sequence data files created by the QX3 and other Yamaha products. (You can also play back the MDF2's SEQ data files).

Using MDR and SEQ data: The SEQ data you record will play back flawlessly if the receiving instrument's settings (such as its MIDI channel and program selections, volume setting, pitch bend and modulation ranges, and so on) are the same as they were when you recorded the data. If these settings are changed, however, the playback might not be quite what you expect. Of course, you could make a note of your settings and restore them manually each time you play back the file; but you can save yourself the trouble and make better use of your MDF3's capabilities by sending them as a bulk dump to the MDF3, then transmitting this data back to the instrument before you play back the sequence data.

JOB MODE

The five JOB mode functions are related to the recording and playback of sequence data files. They allow you to play back SEQ data files repeatedly, or in a programmed order; to change the playback tempo that is recorded to sequence data files; and to control how the MDF3 synchronizes recording and playback with other MIDI sequencers.

Selecting a JOB mode function

To use a JOB mode function, first press the **JOB** key, then use the **FILE DATA** keys to select the function. When the name of the desired function is displayed in the LCD, press the **START/STOP** key.

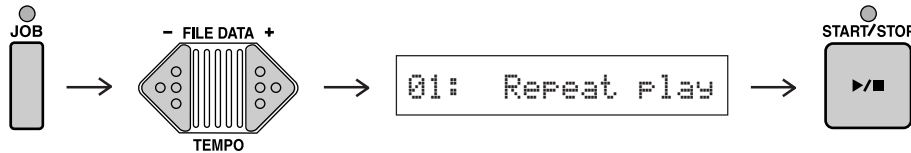

Note that you must place a disk in the disk drive before you select "Repeat play" or "Prog play" in order to use these function.

Exiting a JOB mode function

When you have finished making settings using one of the JOB mode functions, you can exit the function by pressing any of the mode selection keys.

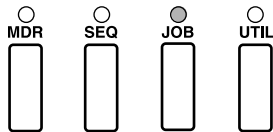

Repeating Playback

The “Repeat play” function lets you play back one or more SEQ files repeatedly. This function could be used to practice a single song several times, or to create an endless loop of background music.

1. In JOB mode, select “01: Repeat play”.

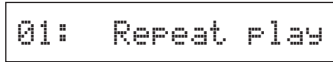

When you press the **START/STOP** key, the current repeat play setting will appear in the LCD.

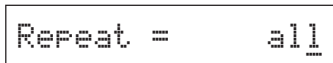

Note: The “Repeat play” function is automatically set to “all” whenever you turn on power to the MDF3. When you play files with this setting, the MDF3 repeatedly plays all of the SEQ data files on the disk in numerical order.

2. Select the desired setting.

Use the **FILE DATA** keys to select one of the three possible repeat settings.

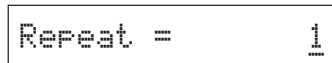
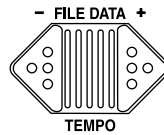

When you select “1”, the MDF3 will play the SEQ data file you select repeatedly.

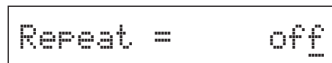

This setting turns the repeat function off.

Hint: You can change the order in which “Repeat=all” plays songs by changing the SEQ file name extensions (see page 59 for details.)

3. Start playback.

Press the SEQ mode key and start playback. The MDF3 will repeatedly play a single song or all of the songs on the disk, depending on the setting you selected.

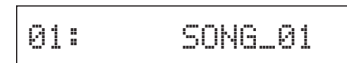
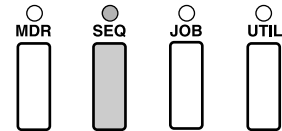

Creating a Playback Program

The "Prog play" function lets you create a program of up to 99 SEQ files to be played back in a specified order.

1. In JOB mode, select "02: Prog play".

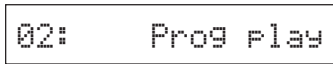

When you press the **START/STOP** key, the following display will appear in the LCD.

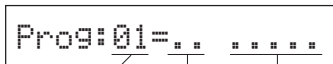

program step file number file name

2. Select a file.

Using the **FILE DATA** keys, select the song to be played for the currently displayed program step.

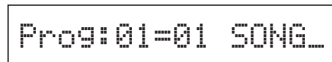
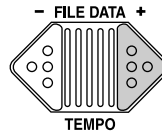

3. Press the START/STOP key.

Your setting for the step will be registered, and the display will change to the next step.

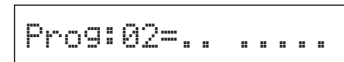

4. Program other steps.

Repeat steps 2 and 3 as needed to program additional steps. Your program may contain up to 99 steps.

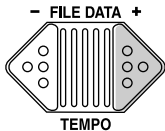

```
Prog:02=07 MissU
```

5. Start playback.

When you've finished creating your program, press the SEQ mode key and start playback. The MDF3 will play the songs you selected in the programmed order.

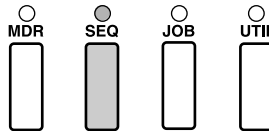

```
01:          SONG_01
```



Hint: If you want to change a step once you've programmed it, press the **CURSOR** [<<] key to move the cursor to the step number area, then select the step you want to change using the **FILE DATA** keys. Then press the **CURSOR** [>>] key and select a different file.

Hint: If you set the "Repeat play" function to either "1" or "all", your entire program of songs will be repeated indefinitely in the programmed order. If the "Repeat play" function is set to "off", however, the program will be played only once.

Note: The program setting is temporary. It will be erased when the MDF3 is turned off, or when you remove the disk from the disk drive.

Changing the Record Tempo

The MDF3 automatically records sequence data at a default tempo of 120 beats per minute. The SEQ data files that you record will be played back at this default tempo unless you change the playback tempo using the **FILE DATA** keys. If you wish, you can use the "Record Tempo" function to set the tempo setting of a file before you start recording it.

1. In JOB mode, select "03: Record Tempo".

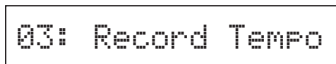

When you press the **START/STOP** key, the current record tempo setting will appear in the LCD.

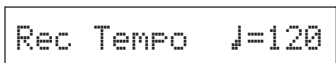
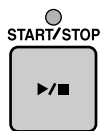

Note: Whenever the MDF3's power is turned on, the record tempo value is automatically set to the default value of 120 beats per minute.

2. Select the desired tempo.

To increase the tempo, press the **FILE DATA** [+] key. To decrease it, press the **FILE DATA** [-] key. The tempo can be changed within a range from 30 to 250 beats per minute.

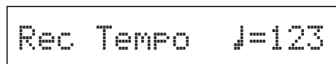
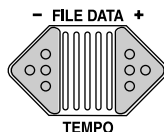

3. Start recording

When you begin recording data in SEQ mode, the tempo you set here will be recorded at the start of the file as the SEQ file's playback tempo.

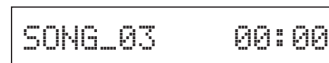
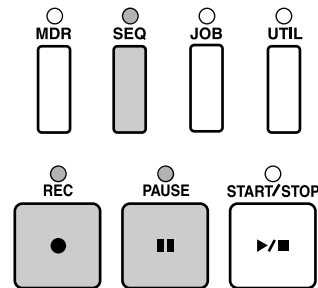

Hint: When you record sequence data played back by a sequencer, you should set the record tempo to a value equal to that used by the sequencer.

When recording data from a keyboard or other digital instrument, you can use this function to record fast musical phrases that would otherwise be difficult or impossible to play. This can be done by setting a faster playback tempo.

Selecting a MIDI Sync Mode

To synchronize the playback of the MDF3 with that of another MIDI sequencer, rhythm machine, or personal computer, it is not enough to merely set the same tempo value for the two devices. One device must be set to function as the master, while the other functions as a slave, synchronizing playback to the MIDI clock signal output by the master rather than its own internal clock. You can change the synchronization setting using the “Sync mode” function.

1. In JOB mode, select “04: Sync mode”.

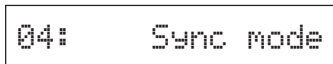

When you press the **START/STOP** key, the current sync mode setting will appear in the LCD.

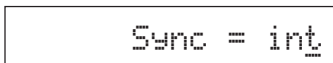

Note: Whenever the MDF3’s power is turned on, the sync mode is automatically set to the internal clock.

2. Select the desired setting.

Using the **FILE DATA** keys, select either setting.

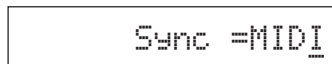
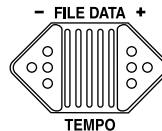

If you set the sync mode to “int.”, the MDF3 will ignore any clock signals output by other devices and run at the tempo set by its internal clock. If you select “MIDI”, the MDF3 will synchronize to an external clock signal, and ignore any tempo settings you have made.

3. Exit the function.

Press any mode key (**MDR**, **SEQ**, **JOB**, or **UTIL**) to exit the function.

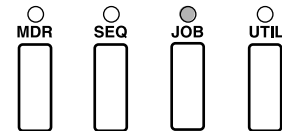

When you next begin recording or playback, the MDF3 will use the sync mode setting you have selected.

Enabling MIDI Control Messages

The “MIDI control” function lets you enable or disable the MDF3’s transmission and reception of MIDI realtime system control (Start, Continue, and Stop) messages. The setting you make here combines with the sync mode setting described on the previous page to determine how MIDI devices control each other during playback.

1. In JOB mode, select “05: MIDI control”.



When you press the **START/STOP** key, the current MIDI control setting will appear in the LCD.

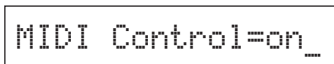

Note: Whenever the MDF3’s power is turned on, the MIDI control function will automatically be set to “on”.

2. Select the desired setting.

Using the **FILE DATA** keys, select either setting.

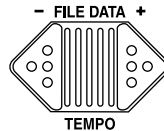

When the MIDI control function is turned on, the MDF3 will transmit and receive Start, Continue, and Stop messages. It will also transmit MIDI clock signals. When this function is turned off, the MDF3 will neither transmit nor receive the MIDI Start, Continue, or Stop messages; nor will it transmit MIDI clock signals.

3. Exit the function.

Press any mode key (**MDR**, **SEQ**, **JOB**, or **UTIL**) to exit the function.

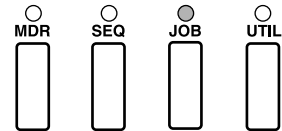

When you next begin recording or playback, the MDF3 will use the MIDI control setting you have selected.

Notes on MIDI Synchronization

The MIDI clock of a sequencing device to be synchronized with the MDF3 must normally be set to a value opposite that of the MDF3. If you want the MDF3 to control the playback tempo, select the “int.” sync mode and set the other device to use the MIDI clock. If the other device is to be the master, reverse these settings. In either case, you should also use the “MIDI control” function to enable the MDF3’s transmission and reception of MIDI system control messages. When synchronizing the MDF3 to another device, both the “Sync mode” and “MIDI control” functions must be set to appropriate values.

The possibilities for combining these settings are summarized in the table below.

04: Sync mode	05: MIDI control	MDF3 operation
MIDI	on	Functions as a slave device.
int.	on	Functions as a master device.
MIDI	off	Cannot be used.
int.	off	Manual playback; no MIDI synchronization.

Note: If an external sequencer or other device connected to the MDF3 retransmits the MIDI data it receives (using a MIDI echo function), avoid a looped MIDI connection or set the MDF3’s MIDI control function to “off”. Otherwise, the MDF3 may malfunction.

UTILITY MODE

The *UTILITY* mode functions let you rename, delete, or copy the files on a disk; append files to one another; or copy the entire contents of one disk to another.

Selecting a UTILITY mode function

To use a *UTILITY* mode function, first press the **UTIL** key, then use the **FILE DATA** keys to select the function. When the name of the desired function is displayed in the LCD, press the **START/STOP** key.

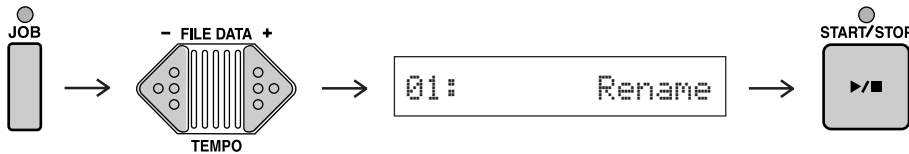

Note: You must place a disk in the disk drive in order to use the “UTILITY mode” functions.

Exiting a UTILITY mode function

When you have finished using a *UTILITY* mode function, you can exit the function by pressing any of the mode selection keys.

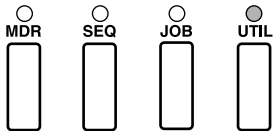

File Names in UTILITY Mode

In UTILITY mode, file names appear differently than in other modes. The letter “M” will appear before the file numbers of MDR data files:

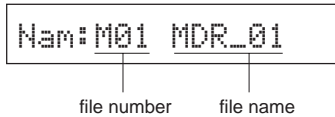

Nam: M01 MDR_01

file number file name

SEQ data files, on the other hand, will be indicated by the letter “S”:

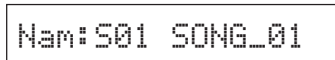

Nam: S01 SONG_01

The files will be displayed in numerical order. The MDR files will appear first, and SEQ files will follow.

If there are no files on a disk, the following display will appear when you select a UTILITY mode function.

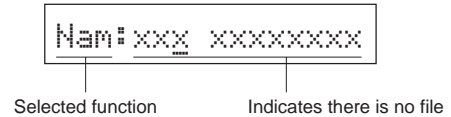

Nam: xxx xxxxxxxxx

Selected function Indicates there is no file

When this display appears, you can not utilize any of the UTILITY mode functions.

Renaming Files

You can give each MDR or SEQ file you create a unique name of up to eight characters. Doing so will make it much easier for you to select a desired file.

1. In UTILITY mode, select "01: Rename"



When you press the **START/STOP** key, the name of the first file on the disk will appear in the LCD.

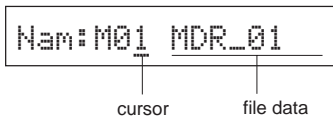

2. Select a file.

Using the **FILE DATA** keys, select a file to rename.

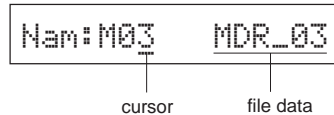
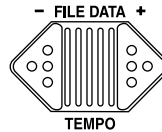

3. Move the cursor to the file name.

Press the **CURSOR** [>>] key to move the cursor to the file name area.

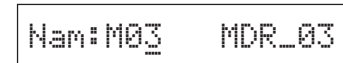
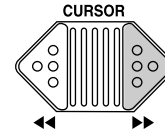

Hint: In addition to MDF3 (or MDF2) files, you can also rename MDR files created by the QX3. Other files cannot be renamed.

4. Change a character.

Using the **FILE DATA** keys, change the character where the cursor is located.

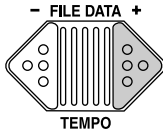

```
Nam:M03  IDR_03
```

5. Move to the next character.

When the desired character appears, press a **CURSOR** key to move to the next letter.

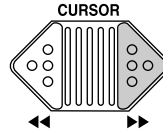

```
Nam:M03  TDR_03
```

6. Press the START/STOP key.

When you've finished changing the name, press the **START/STOP** key. The MDF3 will write the new name to disk.



Available characters:

```
[space] ! " # $ % & ' ( ) * + , - . /  
0 1 2 3 4 5 6 7 8 9 : ; < = > ? @ A B  
C D E F G H I J K L M N O P Q R S T U  
V W X Y Z [ \ ] ^ _ ` a b c d e f g h  
i j k l m n o p q r s t u v w x y z {  
| } ~ +
```

Repeat steps 4 and 5 as needed until you have changed the entire name.

You can now press the **CURSOR** [<<] key to move the cursor back to the file number area and select a new file to rename; or press any of the mode keys (**MDR**, **SEQ**, **JOB**, or **UTIL**) to exit the function.

Hint: You can run through the options rapidly by holding down the **FILE DATA** keys.

Deleting Files

The “Delete” function lets you remove unnecessary files from a floppy disk.

1. In **UTILITY** mode, select “02: Delete”.



When you press the **START/STOP** key, the name of the first file on the disk will appear in the LCD.

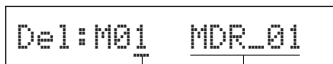

cursor

file data

2. Select a file.

Using the **FILE DATA** keys, select a file to delete.

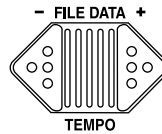

3. Press the **START/STOP** key.

When you are sure of your selection, press the **START/STOP** key. The **MDF3** will delete the file, and the name of the next file in order will appear in the LCD.



Note: You can only delete files created on the **MDF3** (or the **MDF2**) or **MDR** files created by the **QX3**.

Note: If you press the **START/STOP** key at this time, the **MDF3** will delete that file as well. Be very careful not to delete important files! If you want, you can now select a new file to delete; or press any of the mode keys (**MDR**, **SEQ**, **JOB**, or **UTIL**) to exit the function.

Copying or Appending Files

The “Append” function lets you copy files, or append files to each other. If you select two files which contain data as the source and destination files, the data from the source file will be appended to the end of the destination file. If you select an unused file as the destination file, the source file will be copied. (The copied file will be given the same name as the source file.)

1. In UTILITY mode, select “03: Append”.



When you press the **START/STOP** key, the following display will appear in the LCD.

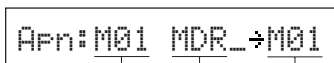

source file number source file name destination file number

2. Select a source file.

Using the **FILE DATA** keys, select the file to be copied or appended.

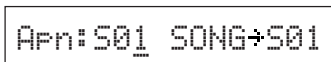
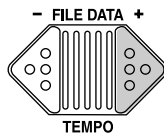

3. Move the cursor to the right.

Press the **CURSOR** [>>] key to move the cursor to the destination file number.

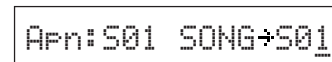
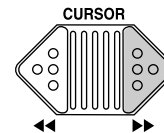

Note: You can only copy or append files created on the MDF3 (or the MDF2).

4. Select a destination file.

Using the **FILE DATA** keys, select the destination file number.

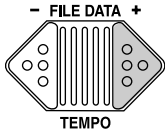

```
Apn:S01 SONG+S03
```

5. Press the START/STOP key.

The MDF3 will append or copy the source file to the destination you specified.



```
Apn:S01 SONG+S03
```

Note: When appending files, the destination file you select must be of the same type (i.e., MDR or SEQ) as the source file. You will not be allowed to append an MDR file to a SEQ file, or vice-versa.

You can now press the **CURSOR** [<<] key to move the cursor back to the source file number area and select a new source file to copy or append; or press any of the mode keys (**MDR**, **SEQ**, **JOB**, or **UTIL**) to exit the function.

Copying Disks

It is always a good idea to make backup copies of disks containing valuable data. The "Backup" function helps you do this by copying all the data on one disk (which is known as the "source" disk) to another disk (which is called the "target").

1. In UTILITY mode, select "04: Backup".



When you press the **START/STOP** key, the following message will appear in the LCD.

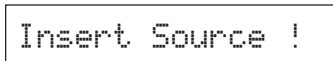

2. Insert the source disk.

Place the disk to be copied in the disk drive.

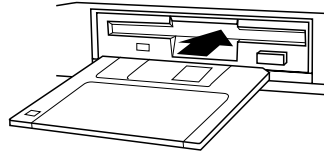

3. Press the START/STOP key.

The following display will appear as the MDF3 reads data from the source disk.

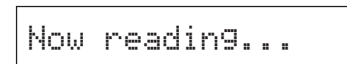

After a few moments, the following message will appear.

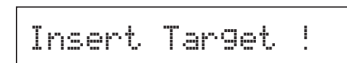

4. Insert the target disk.

Remove the source disk from the disk drive, and insert a newly formatted disk.

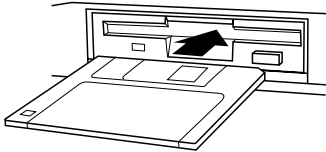

5. Press the START/STOP key.

The following display will appear as the MDF3 writes data to the target disk.



```
Now writing...
```

After a few moments, the “Insert Source!” message will reappear. Repeat steps 2 through 5 until the completed message appears.

```
Completed !
```

6. Back up other disks.

If you want to copy another disk, press the **START/STOP** button; or press the mode keys (**MDR**, **SEQ**, **JOB**, or **UTIL**) to exit the function.

***Hint:** The MDF3 can copy approximately 100 kilobytes of data at one time. When you copy a disk containing a large amount of data, you will have to repeat steps 2 through 5 several times.*

If you want to estimate the number of times you will have to exchange disks to complete the backup process, use the “Disk Info” function to check how much of the source disk has been used before you execute the function.

If you have a personal computer with two disk drive capable of handling 3.5" 2HD/2DD floppy disks, you may find it easier to back up your MDF3 data disks using the computer!

***Note:** Please use the same type of disks to back up your data. If you attempt to back up your data in 2HD disk to 2DD disk or vice versa, the “Bad Disk” message will appear and the backup will be rejected.*

Formatting Disks

As we explained earlier in this manual, a new floppy disk must be formatted before the MDF3 can use it to save data.

1. In UTILITY mode, select "05: Format".



When you press the **START/STOP** key, the following message will appear in the LCD.

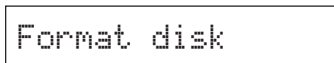

2. Insert a disk.

Insert the disk to be formatted in the disk drive.

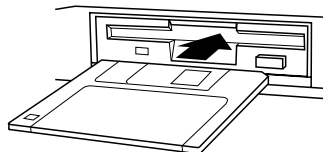

3. Press the START/STOP key.

The LED above the key will light steadily, and the LCD will display a message telling you what percentage of the disk has been formatted. The MDF3 will recognize the inserted floppy disk type (2HD or 2DD) and format it automatically in appropriate size, 1,440 kilobytes for 2HD and 720 kilobytes for 2DD.

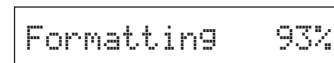

Note: If you format a disk that has been used before, any data it contains will be erased. Make absolutely sure that a disk does not contain any important data before you format it.

When the disk has been formatted, the START/STOP LED will begin to flash again, and the "Format disk" message will reappear. You can repeat the process again to format another disk, or press any mode keys (**MDR**, **SEQ**, **JOB**, or **UTIL**) to exit the function.

Displaying Disk Information

The “Disk info.” function lets you check the amount of available space remaining on a disk. It also displays other information such as the amount of disk space which has already been used, the number of files on the disk, and their respective sizes.

1. In UTILITY mode, select “06: Disk info.”.



When you press the **START/STOP** key, a display showing the amount of disk space which has been used will appear in the LCD.

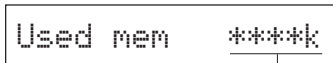

total amount of disk memory used (KB)

2. View other disk information.

Press the **FILE DATA [+]** key once to display the amount of available memory space remaining on the disk.

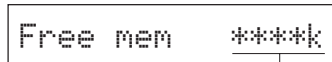
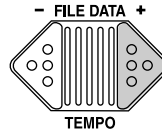

available disk space (KB)

Press the **FILE DATA [+]** key a second time to display the total number of files on the disk.

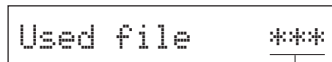

total files on the disk

3. Display file information.

Pressing the **FILE DATA [+]** key additional times will display the name of each file, and its size in kilobytes.

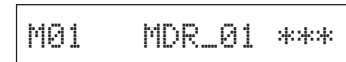
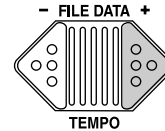

⋮

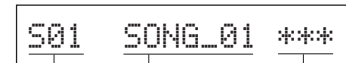

file number file name file size (KB)

Note: You can only see the size of each file created on the MDF3 (or the MDF2) or the MDR files created by the QX3.



THE STANDARD MIDI FILE AND ESEQ FORMATS

The **Standard MIDI File format** is a sequence data file format which has been adopted by a number of sequencing software products for the IBM PC/AT and compatibles, the Apple Macintosh, and a variety of other computers. There are actually two Standard MIDI File formats: Format 0 records all sequencer data for channels 1 through 16 as a single track, whereas format 1 provides for an unlimited number of tracks, each including data for one or more channels.

The **ESEQ format** is a sequence file format particular to Yamaha products. This format is used by a number of popular Yamaha sequencing devices, such as the QX3 and the Clavinova CVP series.

The MDF3 writes its SEQ data files using Standard MIDI File format 0. It is capable of playing back files written by other devices in the Standard MIDI File format 0 or 1, as long as they are stored on a disk which the MDF3 is capable of reading (MS-DOS 1,440 kilobytes (2HD) or 720 kilobytes (2DD)).

Moreover, the MDF3 can play ESEQ sequence files while in SEQ mode. It distinguishes between standard MIDI files and ESEQ files by checking the file header. No conversion process is required to play back ESEQ files.

Note: Files named such as "PIANODIR.FIL", "MUSIC.DIR", "NAME.MDA" included in the ESEQ disks are the setup files and cannot be played back.

If you will use the MDF3 to play sequence files recorded by other devices, be sure to keep these files and your MDF3 (or MDF2) SEQ files on separate disks.

When you place a disk containing only non-SEQ files in the MDF3, it will display the full file name (including the extension) of each file. Should you mix SEQ files together with other sequence files on a single disk, however, the MDF3 will display the names of the SEQ files only, making it impossible to play the other files. Hence the need to keep SEQ files and non-SEQ files on separate disks.

If you have a personal computer, you can trick the MDF3 into playing back ESEQ files (or standard MIDI files created by other devices) which you have saved on disks containing SEQ files. To do so, you must use your computer to change the file name extensions of the non-SEQ files. The method for accomplishing this is described in the following pages.

ADVANCED FILE MANAGEMENT TECHNIQUES

Reading MDF3 Disks with a Computer

The disks you format for use with the MDF3 are compatible with MS-DOS or PC-DOS. This means that you can read the data from your MDF3 disks using an IBM PC/AT-compatible computer. Conversely, the MDF3 will be capable of reading data from 3.5" 2HD/2DD disks formatted by an IBM PC/AT.

Hint: The Atari ST and Apple Macintosh are also capable of reading data from disks formatted by the MDF3. If you own a Macintosh, use a utility program such as PC Exchange, Apple File Exchange or DOS Mounter to read the data from your MDF3 disks.

Try inserting an MDF3 disk into the disk drive of your PC, then display a directory of the disk's contents. You will see a display something like the following:

```
a>dir b:
BE-BOP   .X01   412   00-00-80 12:00
ROLLING  .X02   533   00-00-80 12:00
HOME     .B01   256   00-00-80 12:00
LIVE     .B02   256   00-00-80 12:00
```

Note: The display somewhat varies depending on the computer's operating system you are using.

As you can see, each of the MDF3 file names is followed by a three-character "extension". The MDF3 uses these extensions to organize the files on its disks.

Extensions beginning with the letter "B" indicate that the file in question contains MDR data, whereas files bearing extensions beginning with the letter "X" contain SEQ data.

The second two characters of each extension indicates the file number by which the MDF3 refers to the file. Thus, MDR data file number 01 would have the extension ".B01", whereas SEQ data file number 01 would have the extension ".X01".

If you desire, you can use your computer to change these extensions. Doing so will make possible some "tricky" applications that you normally could not achieve using the MDF3 alone. Some examples are given on the next page.

Changing MDF3 File Name Extensions

Here are a few examples of advanced techniques that become possible when you use a computer to change the extensions of your MDF3 files.

Reordering songs

You will recall that when you set the “Repeat play” function to “all”, the MDF3 will play back each of the SEQ data files on a disk in order. Now, imagine that you have recorded a number of SEQ files to a disk, and suddenly decide you want to play the first and second files in the opposite order.

You could change their order using the “Append” and “Delete” function; but this would be pretty troublesome. It would be much easier to simply insert the disk in your computer, change the extension of file 01 to “.X02”, and then change that of file 02 to “.X01”. When you put the disk back in the MDF3, the songs will have changed place just as if you had gone through the trouble of moving them.

Note: *When you are renaming files, be careful not to give two or more files the same extension. If you do so, the MDF3 will only be able to read one of the files.*

Changing MDR files to SEQ files

The MDF3’s “Prog play” function is handy, so long as the synthesizer or tone generator that plays the data can use the same data setup for all of the songs. But you may find yourself in a situation where you wish you could transmit some bulk data to change the setup between files.

Of course, you can record the bulk data in SEQ mode; but you’d just as soon avoid the trouble this entails. Here’s good news: you can!

Sure, the MDF3 uses extensions to distinguish between MDR and SEQ data files; but this is only done as a matter of convenience. Since both types of data are recorded using Standard MIDI File format 0, there’s nothing wrong with changing the extension of an MDR file to “.X??” and playing it (or even appending it to another SEQ file) as though it were a song.

Mixing SEQ files and other files

The MDF3 will display the names of ESEQ files or standard MIDI files written by other devices only when the disk they are on does not contain any files bearing the “.X??” extension. This makes it difficult, for example, to play a mixture of SEQ files and ESEQ files which have been saved on the same disk.

Fortunately, the MDF3 does not need the extensions to check the file format: it is capable of recognizing standard MIDI files and ESEQ files by checking their file headers. This means that you can fool the MDF3 into displaying the names of non-SEQ files in SEQ mode by changing their file name extensions to “.X??”. Remember, when you attempt this, that the second and third characters of the extension must be numbers, and that the extension must be different from those of all other SEQ files.

There’s another way to trick the MDF3 into playing a mixture of SEQ files and other sequence files: you can rename all the SEQ files on the disk so that they have extensions other than “.X??” (e.g. “MID”). The MDF3 will then treat the disk as though it contained no SEQ files, displaying the full file name of every file.

Note: *If you rename ESEQ files using the former method, you will be able to rename, copy, or delete them just as though they were SEQ files. If you try to use the “Append” function with such files, however, the MDF3 will display an error message.*

A Portable MIDI Playback System

The MDF3, when used in combination with a compact MIDI tone generator module, can form the heart of a portable MIDI playback system. In such a system, you would slave the tone generator to the MDF3 in order to play back SEQ data files which you had recorded previously.

By adding a portable MIDI keyboard to this arrangement, you can add on-the-spot recording to the playback function of the basic system. Make your MIDI connections as seen in the diagrams below.

For recording

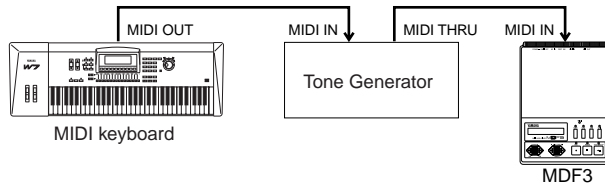

For playback

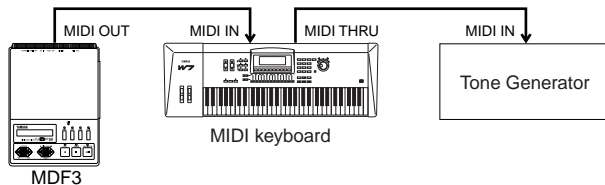

An Extended MIDI System

In a complete MIDI system which already includes a personal computer or a sequencer. In such a system, you would normally use the master keyboard and the sequencer to record parts for each of the slave tone generators, then play the data back all at once. If you connect the MDF3 to the system as shown in the illustration below, you can use it to “capture” the completed performance as SEQ data in Standard MIDI File format.

To do this, set the MDF3’s sync mode to “MIDI” and the MIDI control function to “on”. Then, press the **REC** and **PAUSE** keys. The MDF3 will wait for incoming sequence data to begin recording, then stop recording as soon as the sequencer transmits a MIDI Stop message.

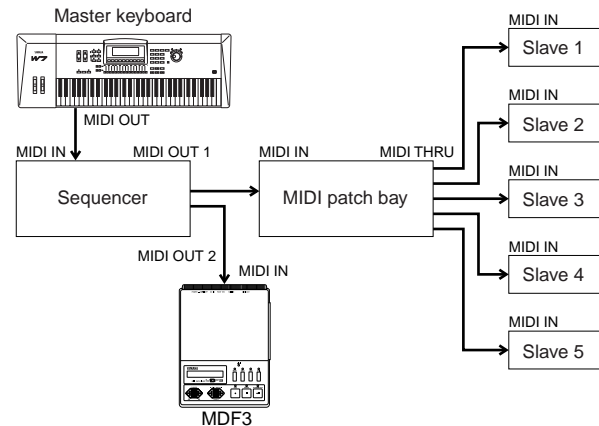

WHAT ERROR MESSAGES TELL YOU

This appendix describes the error messages that can occur while you're using the MDF3, and give you advice on how to solve problems as they occur.

Disk access errors:

! Play only disk

You have tried to record SEQ data to a disk containing only files created by other devices. As a result, the MDF3 has determined that the disk can only be used for playing back sequence data.

Replace the disk with an empty disk, or one which contains sequence data files recorded by the MDF3 (or MDF2).

Note: The MDF3 will only record sequence data to empty disks or disks that already contain files bearing the ".X??" extension. If all of the sequence files on a disk have extensions other than ".X??", the MDF3 will decide that the disk can be used for sequence data playback only.

! Memory Full

The MDF3 has run out of disk space while recording SEQ data or receiving MDR data.

If this message appears while recording SEQ data, the MDF3 will create a SEQ file containing the data that it receives before the error occurred. If the message appears while receiving MDR data, all of the received data will be lost.

Use a disk with enough available space. Check the amount of space remaining on a disk before receiving or recording.

! Disk Protect

The disk in the drive is write-protected, and so the MDF3 cannot receive, record, rename, copy, or delete data on that disk.

Move the write-protect tap up to enable the MDF3 to write data to the disk.

! No disk

A floppy disk has not been inserted into the disk drive. Insert a disk which has been formatted by the MDF3 (or MDF2).

! Unformat disk

The disk in the disk drive has not been formatted, or has been formatted for a device other than the MDF3. Check the disk, and format it if necessary.

! Bad disk

The MDF3 is unable to read or write data using the disk in the disk drive. The disk is either unformatted, or has been formatted by a device other than the MDF3 (or MDF2).

If this message appears after you have formatted a disk, the disk is probably bad. Replace it with a new one.

! Illegal file

You have selected a file written using a data format other than those which the MDF3 is capable of reading.

Select another file. The MDF3 can only read standard MIDI files (format 0/1), ESEQ format sequence data files, and MDR data files created by the QX3 in MDR mode.

! No file

A function cannot be executed because the displayed file cannot be found on the current disk. You have probably changed the disk after selecting a file but before executing the function.

Insert the disk containing the displayed file and execute the function again.

MIDI-related errors:

! MIDI data err

There is something wrong with the MIDI data being received. Check the transmitting MIDI device and the MIDI cable.

! MIDI data full

The amount of MIDI data received at one time has exceeded the MDF3's processing capacity. Decrease the amount of data being transmitted to the MDF3.

Other errors:

! Battery Low

The batteries are running low. The MDF3 is not capable of functioning any longer. If you attempt to use the MDF3 after this message appears, the unit will not operate, or the message will appear again after a few seconds.

Connect the AC adapter or replace the batteries with a new set.

Note: If the "YAMAHA MDF3" initial display appears when you start a playback or recording operation, it means the battery power is so low that the MDF3 cannot display the "Battery Low" error message. Connect the AC adapter or replace the batteries quickly.

! Disk eject

A disk has been removed from the disk drive during playback or recording.

Never eject a disk during playback or recording, as doing so can damage the disk or the disk drive.

ABOUT THE MIDI IMPLEMENTATION CHART

The MIDI implementation chart is useful for determining the function compatibility of different MIDI devices. The chart is essentially a list of the MIDI functions supported by a MIDI device.

The various possible MIDI functions are listed in the far left column of the chart. The two columns to the right of this list tell you whether the device in question supports the transmission and reception, respectively, of MIDI data related to the function. Supported functions are indicated by an “O”, whereas unsupported functions are marked by the letter “X”.

By inspecting a device’s implementation chart, you will get a good idea whether the device is more suitable for use as a master or a slave in your MIDI system. Generally speaking, the more O’s a device has in the transmission column, the better it will perform as a master device; the more O’s it has in the reception column, the better it will serve as a slave.

To determine whether two devices are compatible with regard to a specific function, compare their implementation charts. If one device supports transmission of a function and the other supports reception, the two devices can use the operation.

Note: *The MDF3’s MIDI implementation chart is enclosed with this manual as a separate sheet. This sheet also gives a detailed description of the MDF3’s MIDI functions.*

SPECIFICATIONS

MDR Section:

File Capacity:	99 max.
Recording Capacity:	approx. 1,200 KB per 1 file (when using MF2HD)
Time Resolution:	10 msec./tempo ♩ = 60 (fixed)
Record File Format:	Standard MIDI File format 0
Play File Format:	Standard MIDI File format 0 or Yamaha QX3 MDR

Sequencer Section:

File Capacity:	99 max.
Number of Tracks:	1 (16 MIDI Channels)
Number of Notes:	approx. 150,000 notes (when using MF2HD)
Note Resolution (internal):	1/96 of quarter note
Note Resolution (MIDI sync):	1/24 of quarter note
Tempo (play):	♩ = 30 to 250
Tempo (record):	♩ = 120 (fixed)
Simultaneous Record Notes:	64 max.
Simultaneous Play Notes:	64 max.
Record Mode:	Realtime (replace)
Record File Format:	Standard MIDI File Format 0
Play File Format:	Standard MIDI File Format 0/1 or Yamaha ESEQ

Controls:

Panel Switches:	MDR, SEQ, JOB, UTIL, CURSOR [←], CURSOR [→], FILE DATA [+], FILE DATA [-], REC, PAUSE, START/STOP
-----------------	--

Displays:

LCD:	16 digit liquid crystal display
LED:	green x 4 (MDR, SEQ, JOB, UTIL), red x 4 (REC, PAUSE, START/STOP, MIDI)

External Memory:

Medium:	3.5" 2HD/2DD micro floppy disk
File Capacity:	112 files/disk max. (2DD) 198 files/disk max. (2HD)
Disk Format:	MS-DOS standard
Disk Volume:	1,440 KB (2HD), 720 KB (2DD)

Terminals:

MIDI terminals:	IN, OUT
Power Adapter Terminal:	DC IN
Foot Switch Terminal:	FOOT SW

Power Supply:

Adapter:	Yamaha PA-3B
Batteries:	Size "AA" or LR6 (AM3) alkaline batteries x 6

Dimensions:

162 (W) x 50 (H) x 220 (D) mm
(6-3/8" x 2" x 8-5/8")

Weight:

1.0 kg (batteries and disk not included)
(2 lbs. 3 oz.)

Accessories:

3.5" 2HD floppy disk x 1
MIDI cable x 1

*Specifications are subject to change without notice.

INDEX

A

AC Adapter, connecting 14, DC IN jack 13

Append, file 52

Apple Macintosh 59

Atari ST 59

B

Backup, disk 54

Batteries 14

Block, bulk data 10, headers and footers 29, interval 29

Bulk data, definition 10, recording in SEQ mode 38. See also MDR data.

Bulk dump, definition 10

C

CURSOR key 12

Connection, AC adapter 14, MIDI 15, 62

Continue message 45

Copy, disk 54, file 52

D

DC IN jack 13

Delete, file 51

Disk, access LED 13, backup 54, capacity 7, 29, drive 13, format 56, handling 4, 18, info. 57, write protect 5, 19

Display 12

DOS Mounter 59

E

Eject button 13

Error messages 63

ESEQ files, format 58, playback 38

F

Fast forward, during playback 37

File, appending 52, copying 52, deleting 51, ESEQ format 58, MDR data 29, renaming 49, SEQ data 38, standard MIDI file 58

FILE DATA keys 12

File name, extensions 59, file management techniques 59, renaming files 49, UTILITY mode display 48

Floppy disk, see Disk.

Foot Switch 13

Format, disk 56, ESEQ 58, MDR file 29, SEQ file 38, standard MIDI file 58

Front panel 12

I

IBM PC/AT 59

Indicator, disk access LED 13, MIDI LED 12

Internal clock 44

J

JOB mode, description 20, 39, entering 39, exiting 39, functions 21

K

Keywords 10

L

LCD 12

LED, disk access 13, MIDI 12

M

Master device, MIDI synchronization 44, 46, selecting a master device 65

MDF3 Mode Overview 20

MIDI, applications 62, connections 15, definition 10, data 10, device 10, implementation chart 65, LED 12, MIDI control 45, 46, realtime control messages 45, synchronization 44, 46, sync mode 44, 46, terminals 13

MDR data, definition 11, file format 29, playback as SEQ file 60, reception 24, transmission 27

MDR mode, definition 11, description 20, 23

Mode keys 12

P

Pause, during playback 37, during recording 33, during reception 25, during transmission 28, to start recording 33

PAUSE key 12

Personal computers, file management techniques 59, using MDF3 data files 59

Playback, changing tempo during 36, definition 11, fast forward 37, MDR files 60, procedure 35, programmed 41, record tempo 43, repeated 40, rewind 37

Playback tempo, see Record tempo.

Program play 41

Power, AC adapter 14, batteries 14, switch 13

R

REC key 12

Realtime control messages 45

Reception, definition 11, procedure 24, realtime control messages 45

Recording, bulk data 38, definition 11, procedure 32

Record tempo 43

Rename, file 49

Repeat play, all songs 40, one song 40, program 41

Rewind 37

S

SEQ data, definition 11, file format 38, playback 35, recording 32

SEQ mode, definition 11, description 20, 31

Sequence data, definition 10. See also SEQ data.

Slave device, MIDI synchronization 44, 46, selecting a slave device 65

Song data 11. See also SEQ data.

Specifications 66

Standard MIDI files, format 58, MDR data 29, mixing with ESEQ files 61, SEQ data 38

START/STOP key 12

Start message 45

Stop message 45

Synchronization, see MIDI synchronization.

Sync mode 44

System exclusive data, see Bulk data.

T

Tempo, changing during playback 36, record tempo 43

Terminology 10

Transmission, definition 11, procedure 27, realtime control messages 45

U

UTILITY mode, description 20, 47, entering 47, exiting 47, file name display 48, functions 21

W

Write protect, disk 5, 19

For details of products, please contact your nearest Yamaha or the authorized distributor listed below.

Pour plus de détails sur les produits, veuillez-vous adresser à Yamaha ou au distributeur le plus proche de vous figurant dans la liste suivante.

Die Einzelheiten zu Produkten sind bei Ihrer unten aufgeführten Niederlassung und bei Yamaha Vertragshändlern in den jeweiligen Bestimmungsländern erhältlich.

Para detalles sobre productos, contacte su tienda Yamaha más cercana o el distribuidor autorizado que se lista debajo.

NORTH AMERICA

CANADA

Yamaha Canada Music Ltd.
135 Milner Avenue, Scarborough, Ontario,
M1S 3R1, Canada
Tel: 416-298-1311

U.S.A.

Yamaha Corporation of America
6600 Orangethorpe Ave., Buena Park, Calif. 90620,
U.S.A.
Tel: 714-522-9011

MIDDLE & SOUTH AMERICA

MEXICO

**Yamaha De Mexico S.A. De C.V.,
Departamento de ventas**
Javier Rojo Gomez No.1149, Col. Gpe Del
Moral, Deleg. Iztapalapa, 09300 Mexico, D.F.
Tel: 686-00-33

BRASIL

Yamaha Musical Do Brasil LTDA.
Ave. Reboucas 2636, São Paulo, Brasil
Tel: 011-853-1377

PANAMA

Yamaha De Panama S.A.
Edificio Interseco, Calle Elvira Mendez no.10,
Piso 3, Oficina #105, Ciudad de Panama, Panama
Tel: 507-69-5311

OTHER LATIN AMERICAN COUNTRIES AND CARIBBEAN COUNTRIES

Yamaha Music Latin America Corp.
6101 Blue Lagoon Drive, Miami, Florida 33126,
U.S.A.
Tel: 305-261-4111

EUROPE

THE UNITED KINGDOM

Yamaha-Kemble Music (U.K.) Ltd.
Sherbourne Drive, Tilbrook, Milton Keynes,
MK7 8BL, England
Tel: 01908-366700

IRELAND

Danfay Ltd.
61D, Sallynoggin Road, Dun Laoghaire, Co. Dublin
Tel: 01-2859177

GERMANY/SWITZERLAND

Yamaha Europa GmbH.
Siemensstraße 22-34, 25462 Rellingen,
F.R. of Germany
Tel: 04101-3030

AUSTRIA

Yamaha Music Austria
Schleiergasse 20, A-1100 Wien Austria
Tel: 01-60203900

THE NETHERLANDS

Yamaha Music Nederland
Kanaalweg 18G, 3526KL, Utrecht, The Netherlands
Tel: 030-2828411

BELGIUM

Yamaha Music Belgium
Keiberg Imperiastraat 8, 1930 Zaventem, Belgium
Tel: 02-7258220

FRANCE

**Yamaha Musique France,
Division Professionnelle**
BP 70-77312 Marne-la-Vallée Cedex 2, France
Tel: 01-64-61-4000

ITALY

**Yamaha Musica Italia S.P.A.,
Combo Division**
Viale Italia 88, 20020 Lainate (Milano), Italy
Tel: 02-935-771

SPAIN

Yamaha-Hazen Electronica Musical, S.A.
Jorge Juan 30, 28001, Madrid, Spain
Tel: 91-577-7270

PORTUGAL

Valentim de Carvalho CI SA
Estrada de Porto Salvo, Paço de Arcos 2780 Oeiras,
Portugal
Tel: 01-443-3398/4030/1823

GREECE

Philippe Nakas S.A.
Navarinou Street 13, P.Code 10680, Athens, Greece
Tel: 01-364-7111

SWEDEN

Yamaha Scandinavia AB
J. A. Wettergrens Gata 1
Box 30053
S-400 43 Göteborg, Sweden
Tel: 031 89 34 00

DENMARK

YS Copenhagen Liaison Office
Generatorvej 8B
DK-2730 Herlev, Denmark
Tel: 44 92 49 00

FINLAND

Warner Music Finland OY/Fazer Music
Aleksanterinkatu 11, P.O. Box 260
SF-00101 Helsinki, Finland
Tel: 0435 011

NORWAY

Narud Yamaha AS
Grini Næringspark 17
N-1345 Østerås, Norway
Tel: 67 14 47 90

ICELAND

Skifan HF
Skeifan 17 P.O. Box 8120
IS-128 Reykjavik, Iceland
Tel: 525 5000

OTHER EUROPEAN COUNTRIES

Yamaha Europa GmbH.
Siemensstraße 22-34, 25462 Rellingen, F.R. of
Germany
Tel: 04101-3030

AFRICA

**Yamaha Corporation,
International Marketing Division**
Nakazawa-cho 10-1, Hamamatsu, Japan 430
Tel: 053-460-2312

MIDDLE EAST

TURKEY/CYPRUS

Yamaha Europa GmbH.
Siemensstraße 22-34, 25462 Rellingen,
F.R. of Germany
Tel: 04101-3030

OTHER COUNTRIES

**Yamaha Corporation,
International Marketing Division**
Nakazawa-cho 10-1, Hamamatsu, Japan 430
Tel: 053-460-2312

ASIA

HONG KONG

Tom Lee Music Co., Ltd.
11/F., Silvercord Tower 1, 30 Canton Road,
Tsimshatsui, Kowloon, Hong Kong
Tel: 730-1098

INDONESIA

PT. Yamaha Music Indonesia (Distributor)
PT. Nusantik
Gedung Yamaha Music Center, Jalan Jend. Gatot
Subroto Kav. 4, Jakarta 12930, Indonesia
Tel: 21-520-2577

KOREA

Cosmos Corporation
#13-51, Neung-Dong, Sungdong-Ku, Seoul
Korea
Tel: 02-466-0021-5

MALAYSIA

Yamaha Music Malaysia, Sdn., Bhd.
16-28, Jalan SS 2/72, Petaling Jaya, Selangor,
Malaysia
Tel: 3-717-8977

PHILIPPINES

Yupango Music Corporation
339 Gil J. Puyat Avenue, P.O. Box 885 MCPO,
Makati, Metro Manila, Philippines
Tel: 819-7551

SINGAPORE

Yamaha Music Asia Pte., Ltd.
Blk 17A, Tuo Payoh #01-190 Lorong 7
Singapore 1231
Tel: 354-0133

TAIWAN

Kung Hsue She Trading Co., Ltd.
No. 322, Section 1, Fu Hsing S. Road,
Taipei 106, Taiwan. R.O.C.
Tel: 02-709-1266

THAILAND

Siam Music Yamaha Co., Ltd.
865 Phornphrapha Building, Rama I Road,
Patumwan, Bangkok 10330, Thailand
Tel: 2-215-3443

THE PEOPLE'S REPUBLIC OF CHINA AND OTHER ASIAN COUNTRIES

**Yamaha Corporation,
International Marketing Division**
Nakazawa-cho 10-1, Hamamatsu, Japan 430
Tel: 053-460-2317

OCEANIA

AUSTRALIA

Yamaha Music Australia Pty. Ltd.
17-33 Market Street, South Melbourne, Vic. 3205,
Australia
Tel: 3-699-2388

NEW ZEALAND

Music Houses of N.Z. Ltd.
146/148 Captain Springs Road, Te Papapa, Auckland,
New Zealand
Tel: 9-634-0099

COUNTRIES AND TRUST TERRITORIES IN PACIFIC OCEAN

**Yamaha Corporation,
International Marketing Division**
Nakazawa-cho 10-1, Hamamatsu, Japan 430
Tel: 053-460-2317

HEAD OFFICE

Yamaha Corporation, Electronic Musical Instrument Division
Nakazawa-cho 10-1, Hamamatsu, Japan 430
Tel: 053-460-2445



The background features a series of white, overlapping, wavy lines that create a sense of motion and depth against a dark green gradient. The lines are most concentrated in the center and spread out towards the left and right sides.

YAMAHA

MIDI DATA FILER

LECTEUR DE DISQUETTE MIDI

Owner's Manual
Bedienungsanleitung
Mode d'emploi

MDF3

SPECIAL MESSAGE SECTION

This product utilizes batteries or an external power supply (adapter). DO NOT connect this product to any power supply or adapter other than one described in the manual, on the name plate, or specifically recommended by Yamaha.

WARNING: Do not place this product in a position where anyone could walk on, trip over, or roll anything over power or connecting cords of any kind. The use of an extension cord is not recommended! If you must use an extension cord, the minimum wire size for a 25' cord (or less) is 18 AWG. NOTE: The smaller the AWG number, the larger the current handling capacity. For longer extension cords, consult a local electrician.

This product should be used only with the components supplied or; a cart, rack, or stand that is recommended by Yamaha. If a cart, etc., is used, please observe all safety markings and instructions that accompany the accessory product.

SPECIFICATIONS SUBJECT TO CHANGE:

The information contained in this manual is believed to be correct at the time of printing. However, Yamaha reserves the right to change or modify any of the specifications without notice or obligation to update existing units.

This product, either alone or in combination with an amplifier and headphones or speaker/s, may be capable of producing sound levels that could cause permanent hearing loss. DO NOT operate for long periods of time at a high volume level or at a level that is uncomfortable. If you experience any hearing loss or ringing in the ears, you should consult an audiologist. IMPORTANT: The louder the sound, the shorter the time period before damage occurs.

Some Yamaha products may have benches and / or accessory mounting fixtures that are either supplied with the product or as optional accessories. Some of these items are designed to be dealer assembled or installed. Please make sure that benches are stable and any optional fixtures (where applicable) are well secured BEFORE using.

Benches supplied by Yamaha are designed for seating only. No other uses are recommended.

NOTICE:

Service charges incurred due to a lack of knowledge relating to how a function or effect works (when the unit is operating as designed) are not covered by the manufacturer's warranty, and are therefore the owners responsibility. Please study this manual carefully and consult your dealer before requesting service.

ENVIRONMENTAL ISSUES:

Yamaha strives to produce products that are both user safe and environmentally friendly. We sincerely believe that our products and the production methods used to produce them, meet these goals. In keeping with both the letter and the spirit of the law, we want you to be aware of the following:

Battery Notice:

This product MAY contain a small non-rechargeable battery which (if applicable) is soldered in place. The average life span of this type of battery is approximately five years. When replacement becomes necessary, contact a qualified service representative to perform the replacement.

This product may also use "household" type batteries. Some of these may be rechargeable. Make sure that the battery being charged is a rechargeable type and that the charger is intended for the battery being

charged.

When installing batteries, do not mix batteries with new, or with batteries of a different type. Batteries MUST be installed correctly. Mismatches or incorrect installation may result in overheating and battery case rupture.

Warning:

Do not attempt to disassemble, or incinerate any battery. Keep all batteries away from children. Dispose of used batteries promptly and as regulated by the laws in your area. Note: Check with any retailer of household type batteries in your area for battery disposal information.

Disposal Notice:

Should this product become damaged beyond repair, or for some reason its useful life is considered to be at an end, please observe all local, state, and federal regulations that relate to the disposal of products that contain lead, batteries, plastics, etc. If your dealer is unable to assist you, please contact Yamaha directly.

NAME PLATE LOCATION:

The name plate is located on the bottom of the product. The model number, serial number, power requirements, etc., are located on this plate. You should record the model number, serial number, and the date of purchase in the spaces provided below and retain this manual as a permanent record of your purchase.

Model _____

Serial No. _____

Purchase Date _____