

# Specifications

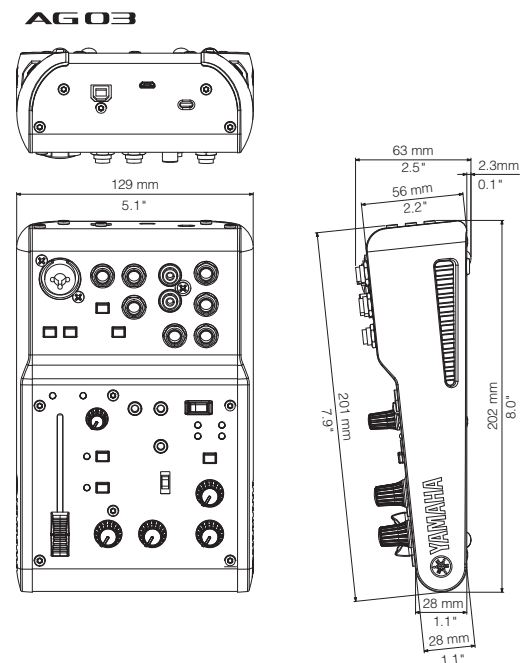

AG06		AG03
Input Channels	Mono (MIC / LINE): 2 including HEADSET MIC (Plug-in Power), Stereo (LINE): 2, USB IN: 1, AUX IN: 1	Mono (MIC / LINE): 1 including HEADSET MIC (Plug-in Power), Stereo (LINE) / Mono (GUITAR): 1, USB IN: 1, AUX IN: 1
Output Channels	STEREO OUT: 1, MONITOR OUT: 1, PHONES: 2 including HEADSET PHONES	MONITOR OUT: 2, PHONES: 2 including HEADSET PHONES
Bus	Stereo: 1	
Input Channel Function	PAD	26 dB
	DSP	CH1: COMP / EQ, EFFECT (SPX Reverb) CH2: AMP SIM, EFFECT (SPX Reverb)
	PEAK LED	LED turns on when the signal reaches 3 dB below clipping level.
Level Meter	USB Output Level	2 x 2 point LED meter [PEAK, SIG]
USB Audio	2 IN / 2 OUT	USB Audio Class 2.0 compliant, Sampling Frequency: Max 192 kHz, Bit Depth: 24-bit
Phantom Power Voltage	+ 48 V	
FOOT SW	EFFECT Mute on / off	
Power Requirements	DC 5 V, 500 mA	
Power Consumption	Max. 2.5 W	
Dimensions (WxHxD)	155 mm x 63 mm x 202 mm (6.1" x 2.5" x 8.0")	129 mm x 63 mm x 202 mm (5.1" x 2.5" x 8.0")
Net Weight	1.0 kg (2.2 lbs)	0.8 kg (1.8 lbs)
Optional Accessory	Foot Switch: FC5, Mic Stand Adaptor: BMS-10A	
Operating Temperature	0 to + 40 °C	

# Dimensions

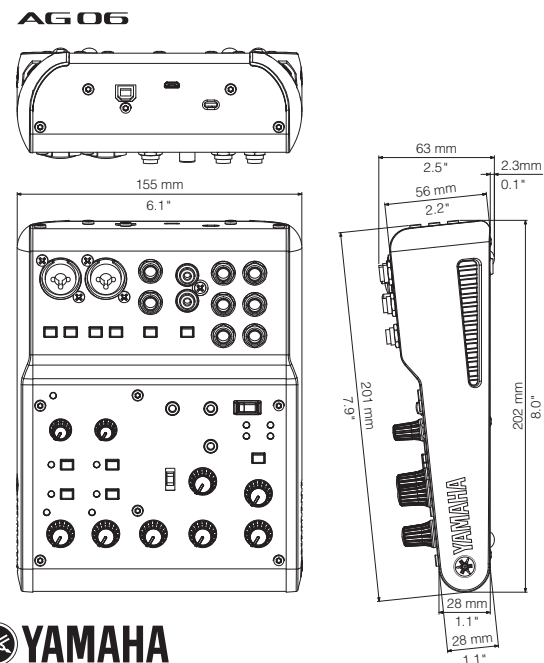

MIXING CONSOLE

**AG06 / AG03**



YAMAHA CORPORATION  
 P.O. BOX1, Hamamatsu Japan  
[www.yamahaproaudio.com](http://www.yamahaproaudio.com)

\*Specifications and appearance are subject to change without notice. \*Steinberg, Cubase, and Cubasis are registered trademarks of Steinberg Media Technologies GmbH.  
 \*All trademarks and registered trademarks are property of their respective owners.



Find your audience.

Find your voice.



The words you speak. The songs you sing.  
Your influences, opinions, and passions take shape in the creations that ultimately become your voice.  
When inspiration hits and you're ready to connect with an audience, whether it's your closest friends or a global network of fans that you haven't even met, you want to be sure that your voice, amongst so many others, is heard.



MIXING CONSOLE  
**AG06**  
MIXING CONSOLE  
**AG03**

AG is a multi-purpose, high-resolution mixer and USB audio interface designed to elevate the creative, audio experience for webcasters / podcasters, gamers, mobile musicians, music producers and more...

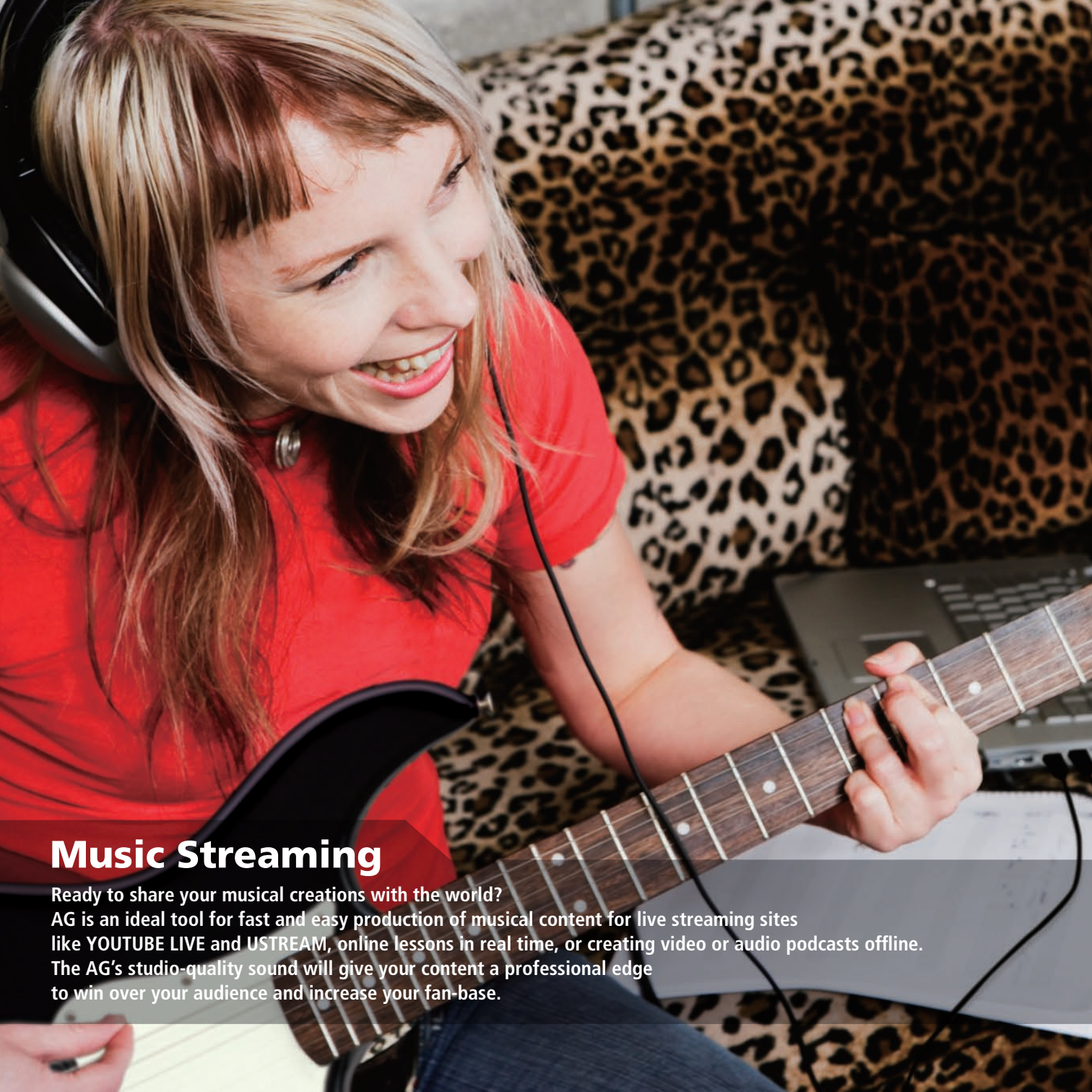

## Music Streaming

Ready to share your musical creations with the world? AG is an ideal tool for fast and easy production of musical content for live streaming sites like YOUTUBE LIVE and USTREAM, online lessons in real time, or creating video or audio podcasts offline. The AG's studio-quality sound will give your content a professional edge to win over your audience and increase your fan-base.

- The AG's LOOPBACK function lets you seamlessly broadcast your live vocal or musical performance online along with backing tracks or additional audio from your PC, Mac or iPad.
- Equipped with studio-quality D-PRE mic preamps your AG will be able to capture the distinctive nuances of your vocal and instrumental performances with high-resolution sound.



## Vocal Performance

- Since AG comes equipped with phantom power, you can connect a wide range of microphones including professional-level condenser mics. The AG also features 1-TOUCH DSP that instantly adds additional depth to your voice. COMP / EQ can smooth out your vocals while EFFECT adds atmospheric reverb with a single touch.



## Instrumental Performance

- The AG's flexible Hi-Z input lets you connect a wide range of instruments like guitars, bass guitars and synthesizers. Yamaha's state-of-the-art signal processing technology provides pro sound that's easy to use with 1-TOUCH DSP. COMP/EQ will hone your tone while EFFECT adds ambient reverb, and AMP SIM\* delivers a classic, warm tube amp sound that will satisfy even the most discriminating guitar enthusiasts—all with the touch of a button.



- With the multi-platform AG DSP Controller software you can access, and edit the compressor, EQ, high-pass filter, reverb, and amp simulator parameters of your 1-touch DSP. EASY mode gives you precise, intuitive control, while EXPERT mode allows you more detailed adjustment of your parameters.

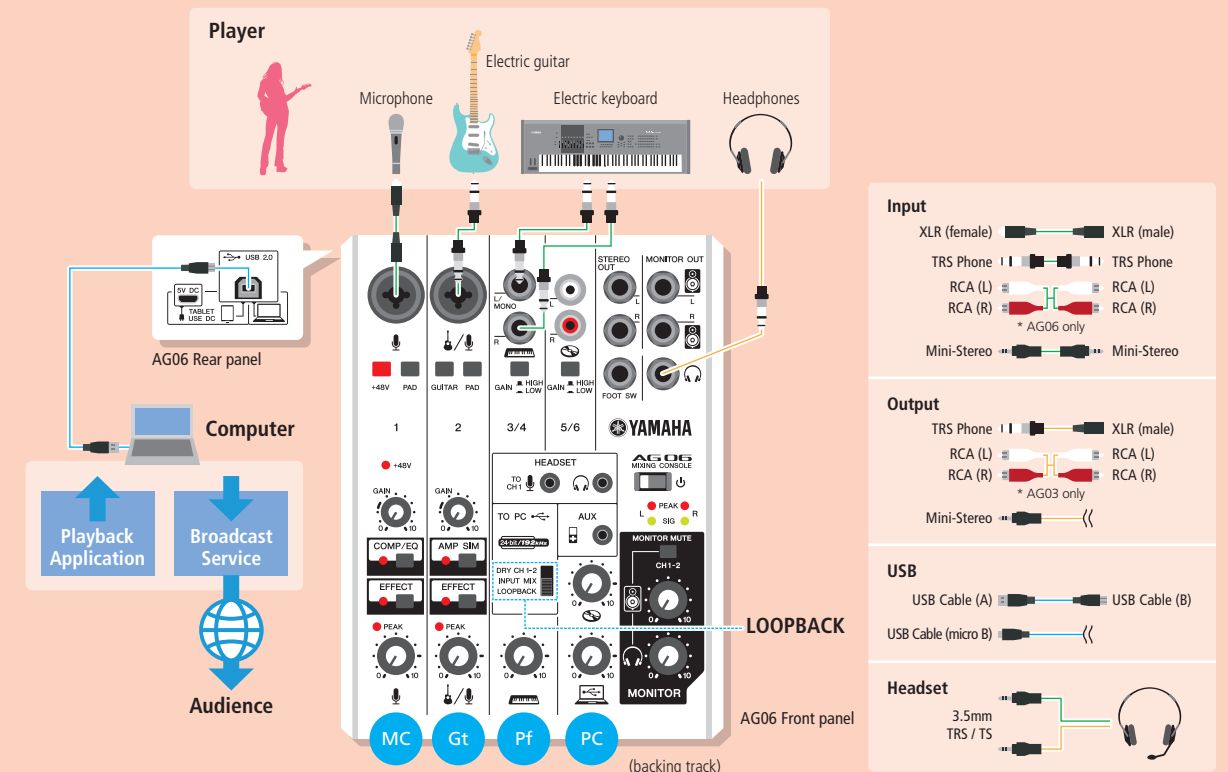

# Webcasting / Podcasting



- The LOOPBACK function enables live broadcasting of all the microphones, instruments and other audio sources along with background music from your PC / Mac or iPad.
- AG comes equipped with an input featuring phantom power as well as a headset input, giving you the option to use a professional condenser mic, or conventional computer headset.
- Both AG models feature volume knobs on the front panel (AG03 comes equipped with a 60mm fader) for simple manual control of your voice, background music, and other audio content or sound effects.



- 1-TOUCH COMP / EQ can add clarity and focus to your sound with the simple click of a button.



- Just like an authentic radio broadcast, you can add reverb with the 1-TOUCH EFFECT or sound effects from an external device at will.



# Webcasting / Podcasting

Transform your PC, Mac or even your iPad into a virtual radio station and spread your message to the world. With a surprisingly easy setup process, the AG lets you produce online content with high-resolution sound, either for real-time broadcast over digital streaming platforms such as USTREAM or YOUTUBE LIVE, or producing on-demand podcasts and videos. Your AG will elevate your production value considerably with background music, sound effects, and a level of sound quality that can't be matched with a conventional computer / headset configuration.

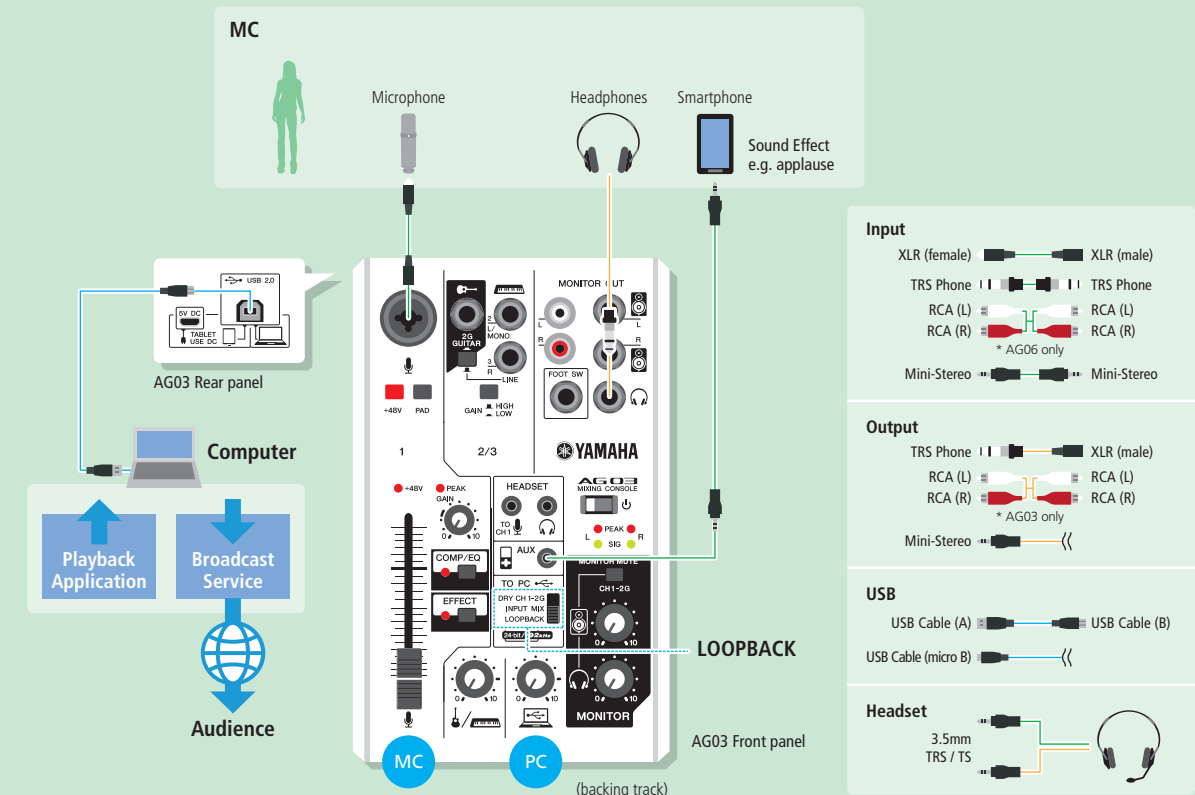

\* Apple and iPad are trademarks of Apple Inc., registered in the U.S. and other countries.



## Gaming (PC game broadcasting)

- AG features 192kHz / 24bit high-resolution sound allowing you to hear gameplay like you've never heard it before. With precise stereo imaging and depth that enhances the realism of your game experience, you will hear and notice nuances that you normally wouldn't with a typical computer sound card. The AG is also equipped with a high quality headphone amplifier that will give your game audio more clarity and power.



- Both AG models feature volume knobs on the front panel (AG03 also comes equipped with a 60mm fader) for simple, yet precise manual control of both your voice and your game audio.

- The LOOPBACK function lets you get your gameplay ready for broadcast without the hassle of a complicated setup.



- AG has a phantom-powered input for any external microphone including professional condenser mics. There's also a dedicated input for your trusted gaming headset.



- With a simple click of a button, 1-TOUCH COMP / EQ can add clarity and focus to your voice.



- AG also features a mute function that can eliminate your own voice from your headset during game play without affecting the overall sound of your broadcast.

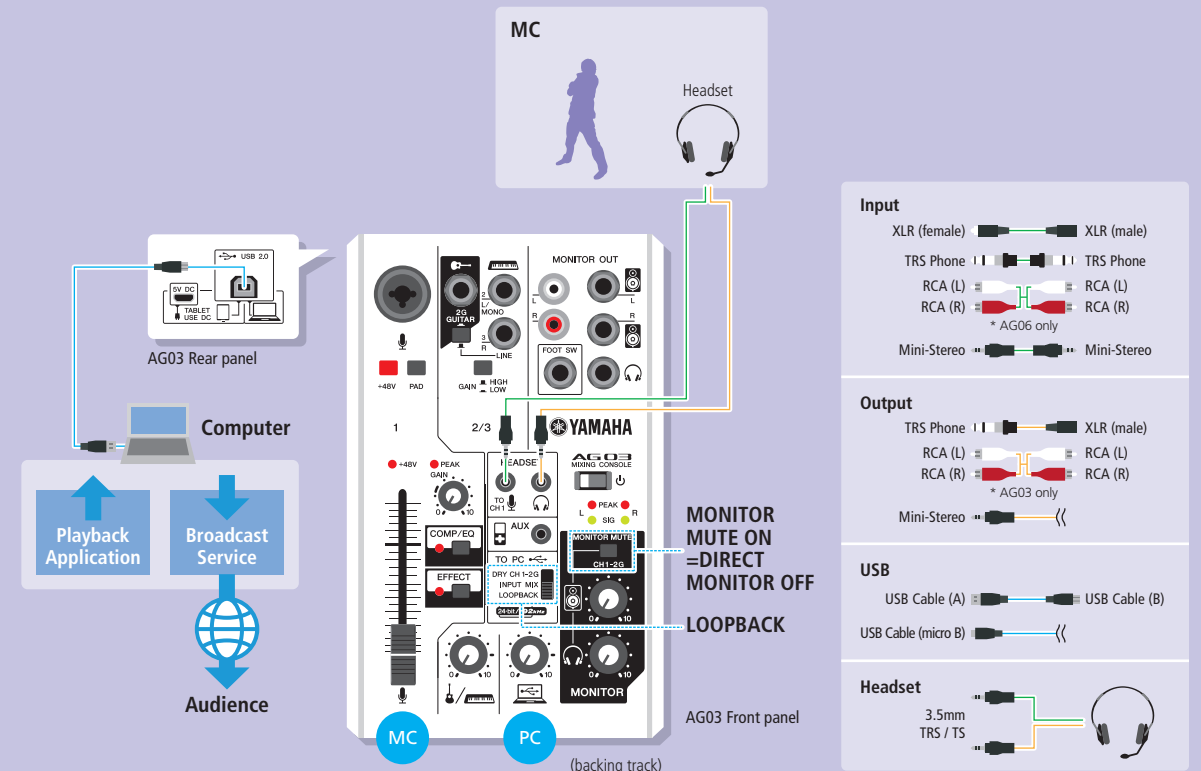

## Gaming (PC game broadcasting)

AG takes your gaming experience to a whole new level, allowing you to immerse yourself in a virtual world with the realistic sounds and superb audio that the latest game technology offers. In addition you can share your gaming skills in real time with other gamers in high-quality sound via game distribution services like TWITCH. Just try AG once and you'll realize exactly what you've been missing using a conventional computer mic / headset system.



## Mobile Music

You never know where your music will take you. By simply connecting a compatible iPad and a USB mobile battery, the AG becomes an ideal mobile audio interface for musicians and sound designers on the go. This modest configuration can transform your iPad into a mobile studio, or even a virtual instrument performance platform, allowing you to produce high-quality music anywhere, anytime.

- The compact and durable AG can be operated using USB bus power or a mobile battery, giving you a powerful mobile setup that can fit easily into a guitar case or a backpack.
- Using the iPad music production application Cubasis, you can do full-fledged music production when you're away from home.



\* Cubasis is sold separately by Steinberg Media Technologies GmbH through Apple's App Store.

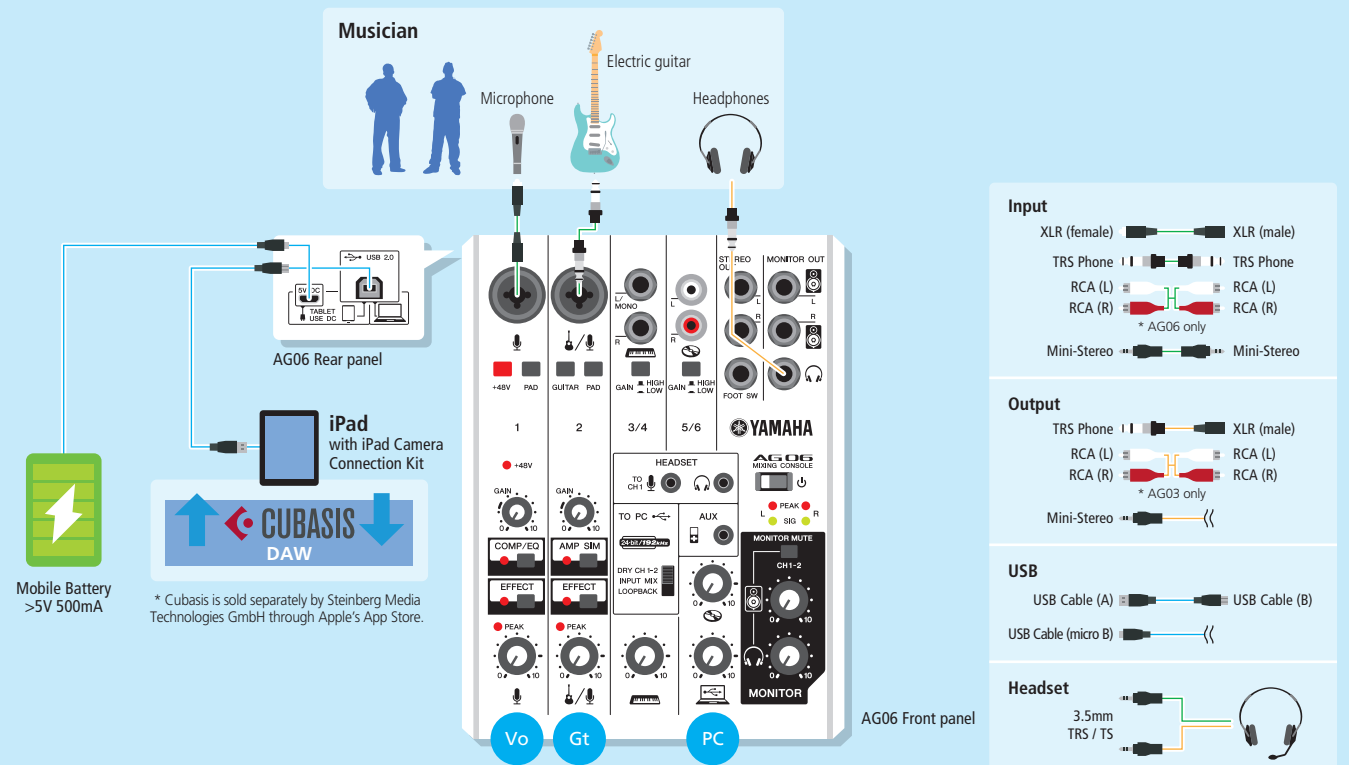

- Equipped with studio quality D-PRE mic preamps your AG will be able to capture the distinctive nuances of your vocal and instrumental performances with its high-resolution sound.
- Flexible connectivity with phantom power and Hi-Z switchable inputs make AG compatible with a wide variety of mics and instruments, including guitars, bass guitars and synthesizers, that can connect directly to AG. With headphones you can easily monitor the sound from the iPad and input source from the AG



# Music Production

- AG comes bundled with Cubase AI (download) that condenses the composing, recording, editing and mixing functions based on industry standard Cubase music production software, letting you start the music production process right away. 
- AG features up to 192kHz / 24bit sound quality, faithfully reproducing the most detailed sonic characteristics of your performance with flawless fidelity. 
- Equipped with studio-quality D-PRE mic preamps your AG will be able to capture the distinctive nuances of your vocal and instrumental performances with high-resolution sound. 

- Flexible connectivity with phantom power for studio quality mics and Hi-Z switchable inputs make AG compatible with a wide variety of instruments, including guitars, bass or synthesizers, that can connect directly to your AG. 
- Compatible with PC and Mac computers, you can create a high quality recording environment with a single connection. USB bus power allows you to operate your AG without an external power source keeping your required space to a minimum.

# Music Production

Combining high end D-PRE mic preamps with 192kHz / 24bit sound capability, in a compact yet comprehensive design, the AG is perfect for musicians and music enthusiasts who want to compose, record and mix their music with a streamlined setup without sacrificing sound quality. With the bundled Cubase AI music production software downloaded onto your Windows or Mac computer, you've got everything you need to start recording your music in high-quality sound.

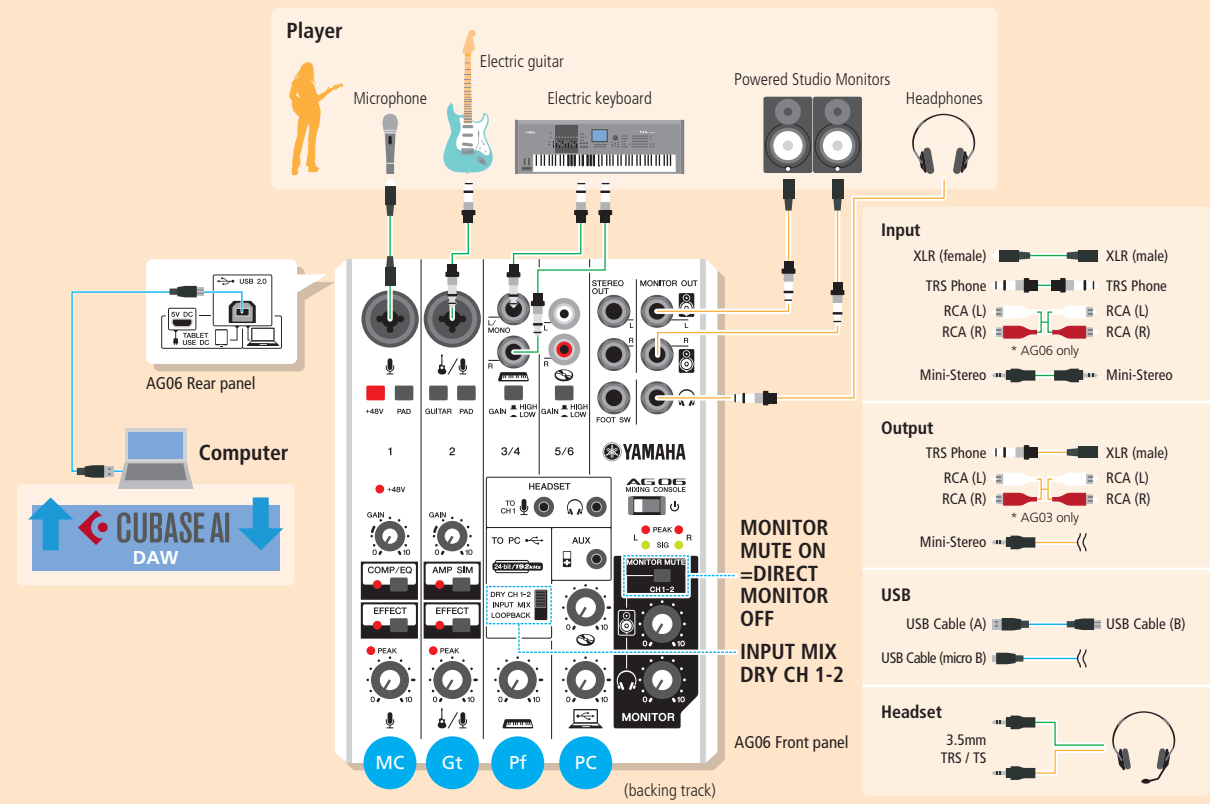



## Compact Mixing

When used with a PC, Mac or iPad and mobile battery, AG's unassuming construction and lightweight design make it easy to add serious sound quality to compact mixing for live solo / duo performances, or even karaoke. Housing the professional level D-PRE mic preamps and high-end processor, and a variety of inputs / outputs, the compact chassis of the AG can easily be placed on a keyboard, guitar case or mic stand using an optional adapter for convenient real time mixing of your performance.

- Equipped with studio-quality D-PRE mic preamps your AG will be able to capture the distinctive nuances of your vocal and instrumental performances with high-resolution sound.
- Compact and lightweight design allows for easy, accessible placement in your live setup.

**D-PRE**  
Direct Pre Amp

## Vocal Performance

- Since AG comes equipped with an input featuring phantom power, you can connect a wide range of microphones including professional-level condenser mics. The AG also features 1-TOUCH DSP that will instantly add additional depth to your voice. COMP/EQ can smooth out your vocals while EFFECT adds atmospheric reverb with a single touch.

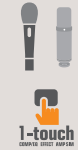

## Instrumental Performance

- With flexible connectivity and a Hi-Z switchable input you can connect a wide range of instruments such as guitars, bass, or synthesizers, directly into your AG. It also features 1-TOUCH DSP that utilizes Yamaha's state-of-the-art signal processing technology. COMP/EQ will hone your tone while EFFECT adds ambient reverb, and AMP SIM\* delivers a classic, warm tube amp sound that will satisfy even the most discriminating guitar enthusiasts—all with the touch of a button. \*AG06 only
- With the multi-platform AG DSP Controller software app you can access, and edit the compressor, EQ, high-pass filter, reverb, and amp simulator parameters of your 1-TOUCH DSP. EASY mode gives you precise, intuitive control, while EXPERT mode allows you more detailed adjustment of your parameters.

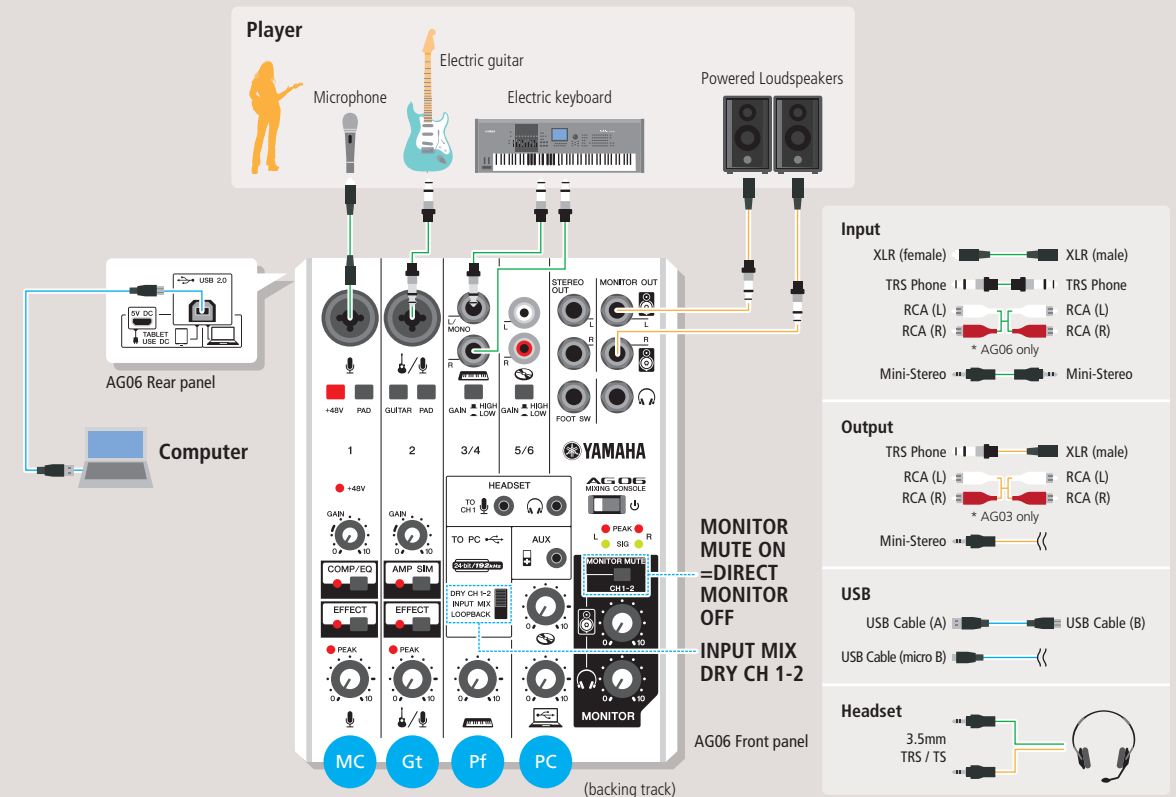



## Desktop Audio

Prepare for a listening experience unlike any other when you add AG to your favorite/ trusted headphone, studio monitor or home audio setup. AG's 192kHz/24bit sound is well above CD quality, allowing you to experience breathtaking nuances of your favorite recordings that will seemingly transport you back to the original studio or concert hall it was recorded. The highest quality AD converter in its class allows you to digitally archive your precious analog recordings with a quality and fidelity that faithfully captures the essence of the original recording.

### Listening

- AG's high-quality design enables 192kHz / 24bit sound that can reproduce even the most subtle nuances of your original recordings.
- You can use a variety of compatible playback applications such as iTunes, Media Player, or foobar2000. If you use ASIO compatible playback software, you can even bypass the internal Kernal mixer and reproduce the original sound faithfully.
- AG is USB bus powered, affording you instant operation with a single USB connection, as well as a reduction in required space for convenient placement of your AG.



### Digital archiving

- AG's 192kHz/24bit sound quality is ideal for capturing the purest reproduction of your analog recordings when archiving your treasured collection.

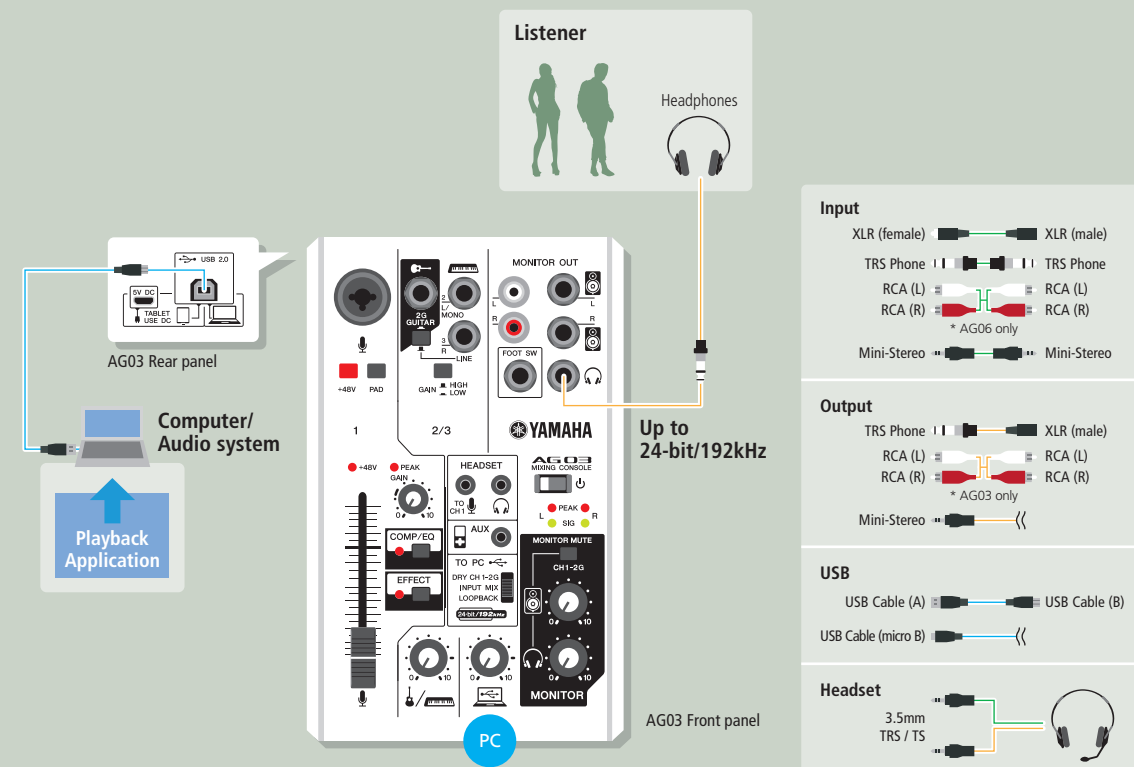



# Education

An aspiring artist resides in all of us, and the AG can serve as a valuable educational platform, unlocking creativity in students and teachers alike. Teachers can use the AG as an audio interface for music production or film classes, remote lessons in real time for another classroom or online, or creating offline teaching content for social networking sites.

- The AG comes equipped with an input featuring phantom power as well as a headset input, giving you the option to use a professional condenser mic setup, or a conventional headset.
- Both AG models feature volume knobs on the front panel (AG03 also comes equipped with a 60mm fader) for simple, yet precise manual control of your volume levels.
- Equipped with studio-quality D-PRE mic preamps your AG will be able to capture the distinctive nuances of your vocal and instrumental performances with high-resolution sound.



- With a simple click of a button, 1-TOUCH COMP / EQ can add clarity and focus to your sound.
- AG has a security slot to prevent theft which is an asset for schools and educational facilities.

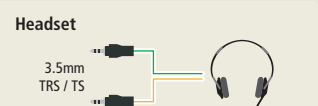
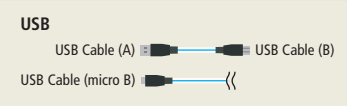
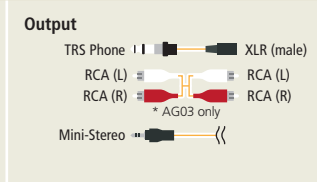
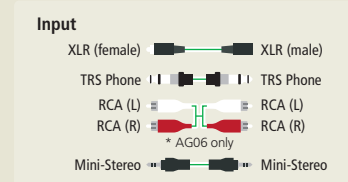
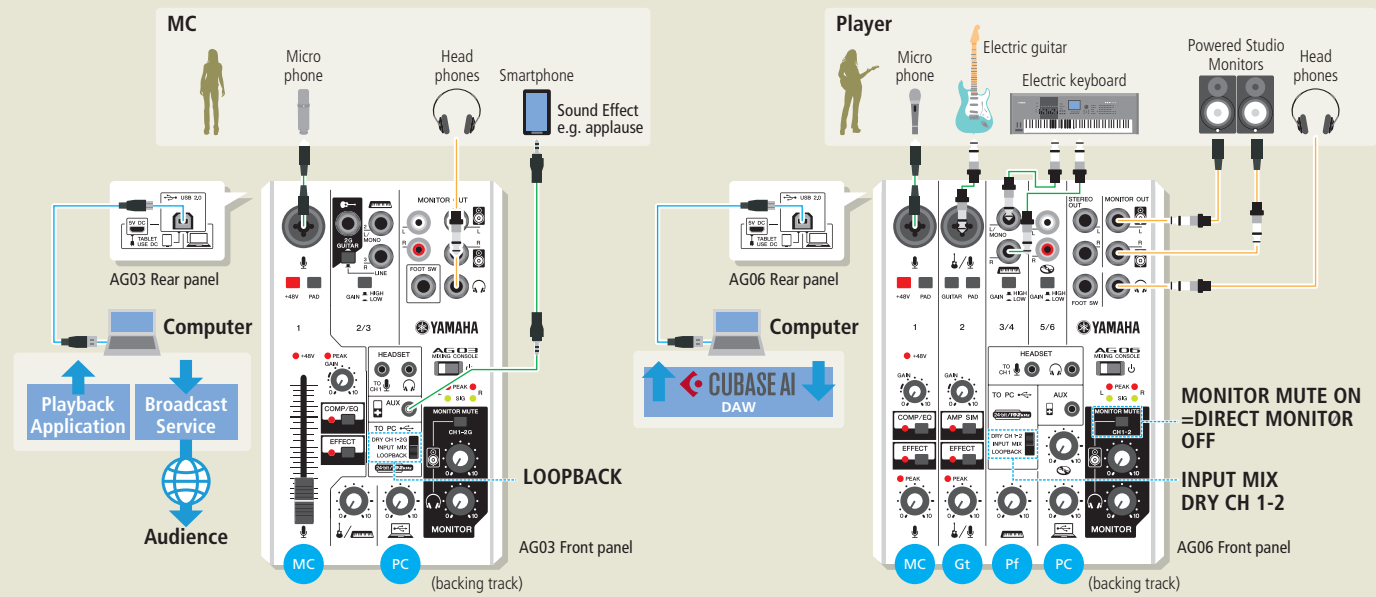



**Flexible connectivity**

Phantom Power and a Hi-Z switchable input allow you to connect a variety of microphones, instruments and external audio players directly into your AG, while front panel volume knobs and a fader\* provide fast and easy volume control.  
\*AG03 only



**High resolution (192kHz / 24bit) playback and recording**

AG's high-resolution sound reproduces every subtlety of your performances and recordings with flawless fidelity and accurate imaging, ideal for music production, mixing and broadcasting, as well as high-definition listening.



**D-PRE studio quality mic preamp**

AG features the same premium mic preamps developed by Yamaha for high-end recording consoles, capturing most detailed nuances of your vocal or instrumental performance.



**1-TOUCH DSP offers professional sound with a single touch**

AG features 1-TOUCH DSP that utilizes Yamaha's state-of-the-art signal processing technology. COMP/EQ will hone your tone while EFFECT adds ambient reverb, and AMP SIM\* delivers a classic, warm tube amp sound—all at the touch of a button.  
\*AG06 only



**AG DSP Controller allows additional control of DSP settings**

Compatible with Windows and MAC, AG DSP Controller gives you additional control of 1-TOUCH DSP parameters such as COMP, EQ, HPF, reverb, and the AMP SIM. EASY mode utilizes a simple intuitive interface while EXPERT mode gives users more detailed control.  
<http://www.yamahaproaudio.com/ag/>



**LOOPBACK function for internet live streaming**

The LOOPBACK function consolidates all input channels and playback tracks, and routes the mix to your internet streaming software for easy live streaming of performances to the internet.



**Class Compliant mode for iPad connection**

AG is compatible with Apple's second generation iPad or later, allowing you to create high quality recording and playback using an iOS compatible music app such as Cubasis.  
\*Apple iPad Camera Connection Kit/ Lightning to USB Camera Adapter required



**Durable, compact metal chassis**

The tough metal body of the AG is extremely portable and easy to place on a keyboard, on a guitar case, or even on a mic stand using an optional adaptor.



**USB bus powered or mobile battery**

AG can operate using USB bus power eliminating the need for an external adaptor. AG can also be driven by a mobile battery for use with an iPad providing users with a true mobile mixing and audio interface solution.



**CUBASE AI Music Production Software**

CUBASE AI Digital Audio Workstation (DAW) software is included with your AG purchase giving you a streamlined but powerful music production tool for making high-quality recordings right out of the box.  
<http://www.yamahaproaudio.com/ag/>

# Simple explanation of features

# Connection examples

AG 06

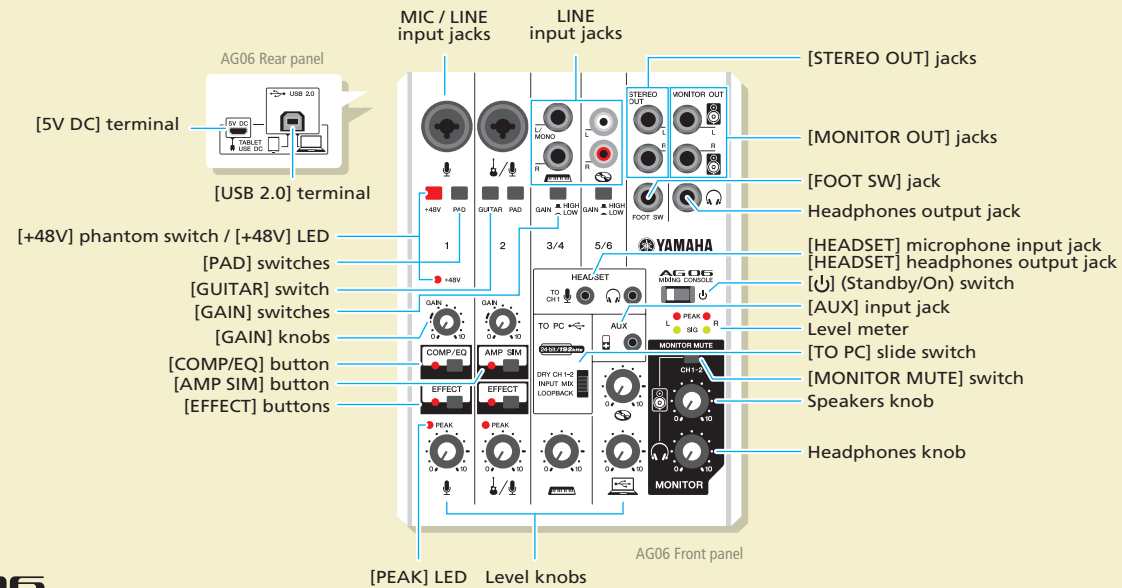

AG 06

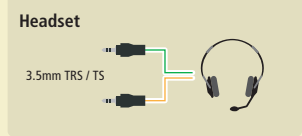
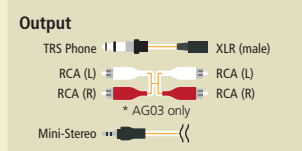
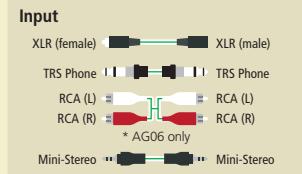
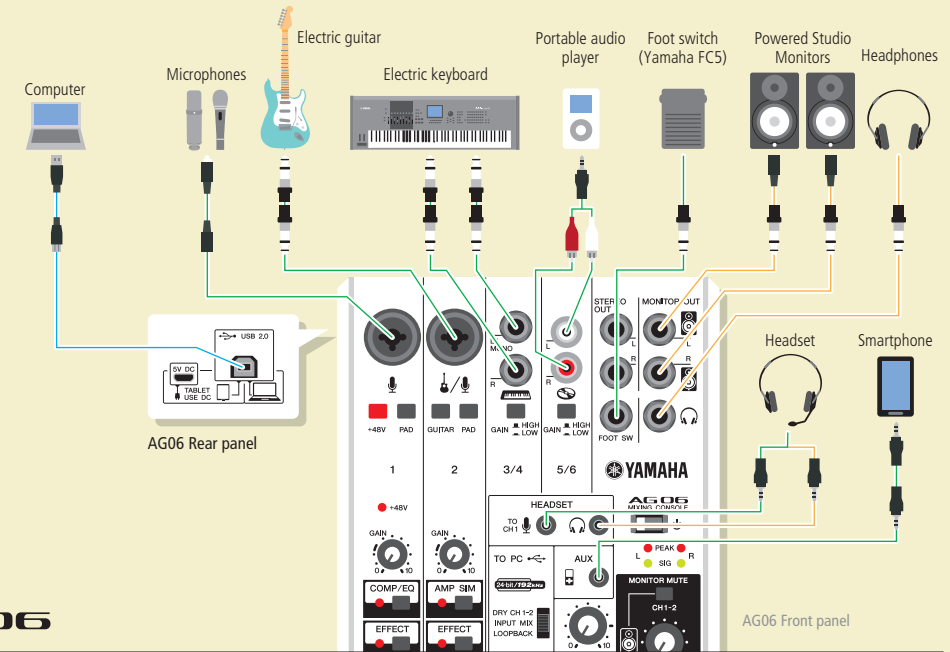

AG 03

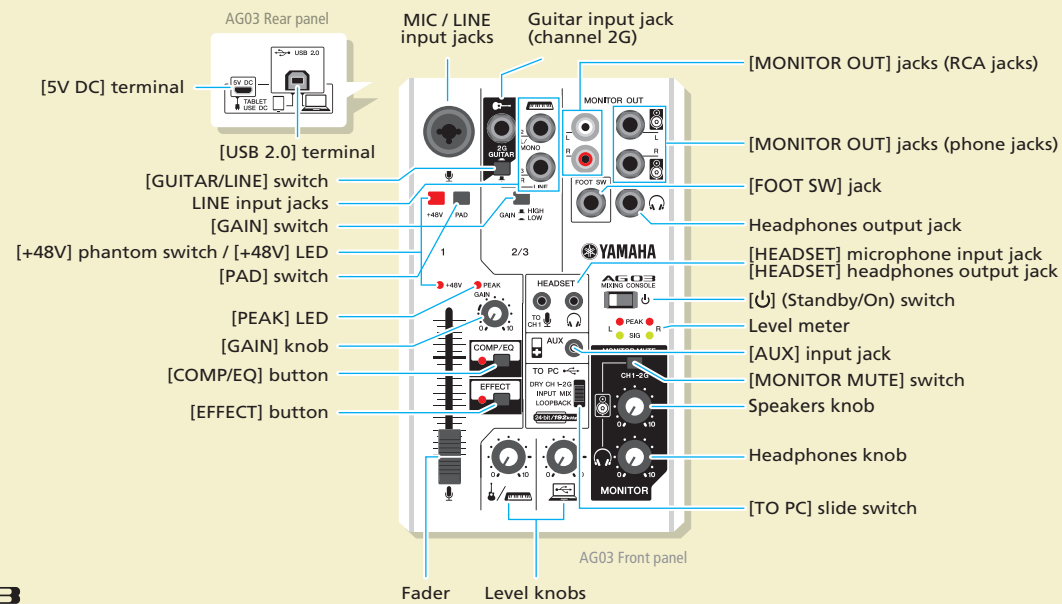

AG 03

